



Specification

For

LCD Module

CCM2441CSL-C

CUSTOMER APPROVED:

--

PREPARED BY	CHECKED BY	APPROVED BY
Gao chang wen	Xie feng	Chang chong hui



RECORDS OF REVISION

Date	Rev.	Description	Note	Page
2008.7.30	1.0	New specation		



CONTENTS

1	FEATURES	
2	ABSOLUTE MAXIMUM RATING	
3	MECHANICAL PARAMETERS	
4	LED BACKLIGHT CHARACTERISTICS	
5	SYSTEM BLOCK DIAGRAM	
6	PIN DESCRIPTIONS	
7	CHARACTERISTICS OF LCD MODULE	
8	ELECTRICAL CHARACTERISTICS	
9	TIMING CHARACTERISTICS	
10	COMMAND DESCRIPTION	
11	CHARACTER FONT TABLE	
12	RELIABILITY	
13	SPECIFICATION OF QUALITY ASSURANCE	
14	INSPECTION CRITERIA	
15	PACKAGE SPECIFICATION	
16	PRECAUTION IN USE OF LCD PANELS & LCM	
17	ASSEMBLY DIAGRAM	



CCM2441CSL-C LCD MODULE

1. Features

- Display Type: STN
- Display Mode: Yellow-green
- Display Format: 24 Characters x 4 Lines
- Input Data: 4-Bits interface available
- Polarize Type: Transflective, Positive
- Driving Mode: 1/16Duty, 1/5Bias
- Operating Voltage: 4.5V
- Viewing Direction: 6 O'clock
- Accord with ROHS

2. Absolute Maximum Rating

Item	Symbol	Min.	Max.	Unit
Power Supply for Logic	Vdd	-0.3	+7.0	V
Power Supply for LCD Drive	Vlcd	Vdd-13.5	Vdd+0.3	V
Input Voltage	Vi	-0.3	Vdd+0.3	V
Operating Temperature	Topr	0	+50	°C
Storage Temperature	TSgt	-20	+70	°C

3. Mechanical Parameters

Item	Description	Unit
LCM Outline Dimension	93.0 x 60.0 x12.25 (MAX)	mm
Viewing Area	80.5 x 39.0	mm
Weight	About 40.0	g

4.LED Backlight CHARACTERISTICS

Item	Symbol	min.	typ.	max.	Unit	Condition
Forward Voltage	Vf	4.0	4.2	4.4	V	If= 60*2 mA
Reverse Current	Ir			40*2	μA	Vr= 10.0 V
Peak wave length	λρ		570		nm	If= 60*2 mA
Spectral Line Half width	Δλ		35		nm	If= 60*2 mA
* Luminance	Lv				cd/m ²	If= 60*2 mA

5. System Block Diagram

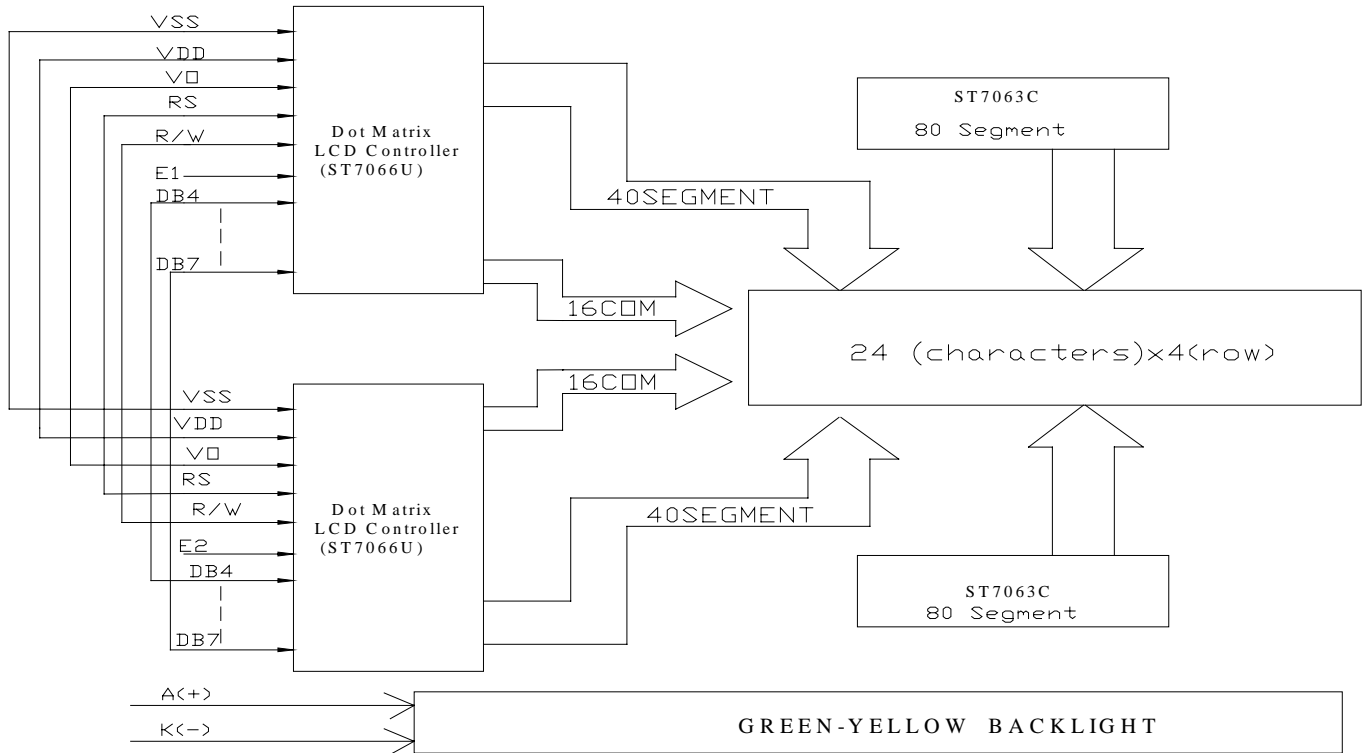

6. Pin Descriptions

NO.	Symbol	Level	Function
1	VSS	--	GROUND
2	VDD	--	POWER SUPPLY FOR LOGIC
3	VEE	--	POWER SUPPLY FOR LCD
4	RS	H/L	Register Select H: Data register L: Instruction register
5	R/W	H/L	H--Read L--Write
6	E1	H, H-L	Start enable signal to read or write the data
7	E2	H, H-L	
8	NC	--	
9	NC	--	
10	NC	--	
11	DB4	H/L	Data bus for 4 bit transfer
12	DB5	H/L	
13	DB6	H/L	
14	DB7	H/L	
15	A	H	LED+
16	K	L	LED-



7. Characteristics of LCD Module

1. Driving Conditions 驱动条件

Voltage 电压	Duty 占空比	Bias 偏压比
4.50V	1/16	1/5

2. Maximum Rating 温湿范围

Item 项目	Standard value 标准值	Unit 单位
Operating temperature 操作温度	0 ~ +50	°C
Storage temperature 储存温度	- 20 ~ +70	°C
Humid condition 温湿度	70°C Dry condition 70°C干燥条件 60°C less than 90%R.H 60°C湿度低于90%R.H 40°C less than 95%R.H 40°C湿度低于95%R.H	

3. Electro-optical Characteristics 光电参数

No	Item 项目		Symbol 符号	Temperature 温度(°C)	Standard Value 标准值			Unit 单位	REMARK 备注
					Min	Type	Max		
1	Threshold Voltage 阈值电压		Vth	25	Vth 2	4.15	5.15	V	Note.1
					Vth 1		4.13		
2	Response Time 响应时间	Rise Time 上升时间	t _r	25		100	150	Ms	Note.2
		Decay Time 下降时间	t _f	25		255	305		
3	Frame frequency 帧频率		fF			64		Hz	Note.3
4	Viewing Angle 视角		Φ = 0°	θ 1			20	deg	Note.5
			Φ = 90°	θ 2			10		
			Φ = 180°	θ 3			20		
			Φ = 270°	θ 4			30		
5	Current Consumption 消耗电流		I	25			5	UA	Note.4
6	Contrast Ratio 电对比度		Cr	25	4	6			Note.6

. OTHER/其他

[Note 1]注1

Threshold voltage (Vth) and Von , Voff (Fig. 1)/阈值电压及开关电压

Equipment & Conditions/仪器及条件

Equipment/仪器: E0—100 (BFI)

Environment conditions/环境条件: 25°C ±3°C

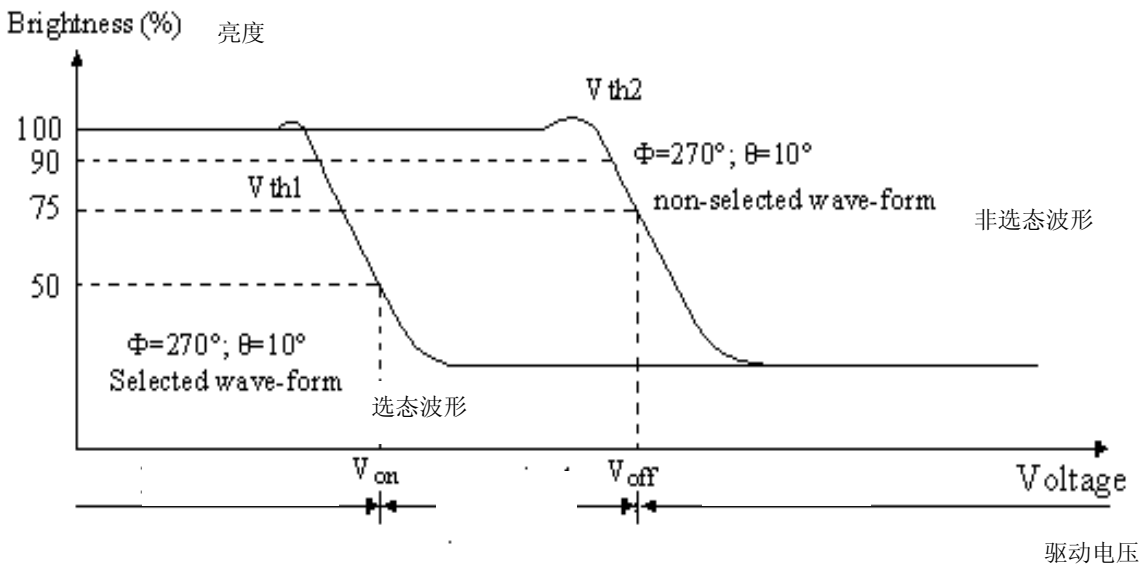

Fig.1 图1

[Note 2] 注2

Definition and Measurement Condition of Response Tim

响应时间的定义和测量条件

Definition定义:

Rise Time(Tr): 上升时间: The time required for a LCD to get 90% contrast from 10% level
LCD的对比度从10%上升到90%所需要的时间

Decay Time(Tf): 下降时间: The time in which contrast falls from 90% level to 10% level
LCD的对比度从90%下降到10%所需要的时间

Conditions条件:

- a) Temperature 温度 : 25°C
- b) Frame Frequency 频率 : 64Hz
- c) Viewing Angle 视角 : $\theta=10^\circ, \Phi=270^\circ$
- d) Applied Voltage 电压 : V

Contrast Ratio

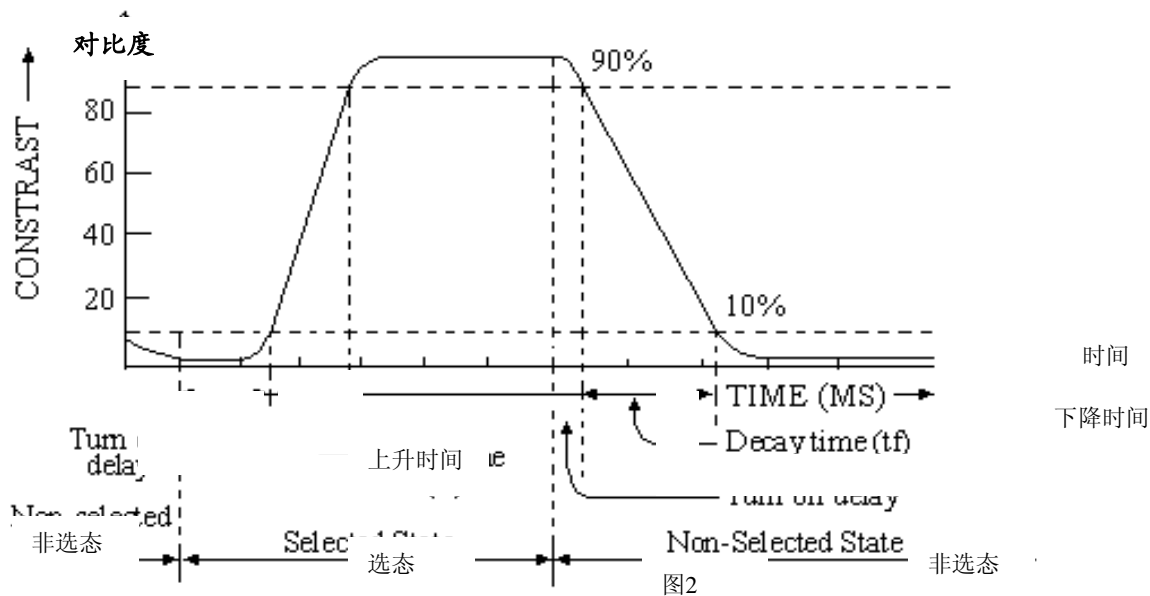

[Note 3]注3

Frame Frequency /频率 : 64 Hz

Equipment 仪器:

LCD Tester LCD测试机 : RPG 3200

Unltimeater 调校仪 : Fluke 87

[Note 4]注4

Definition and Measurement Condition of Current Consumption

电流的定义和测量条件

Definition/定义:

Current Consumption/电流: The total maximum current that the LCD draws
LCD全部显示时的电流

Equipment:

LCD Tester: RPG 3200

[Note 5]

Definition of viewing angle (θ) and viewing direction (Φ)

视角及视角方向的定义



图3

- (1) Z is the normal line perpendicular to the LCD surface. /Z垂直于LCD表面
 (2) θ shows the viewing angle for LCD, starting from the normal line. / θ 是视线与Z轴的角度
 (3) Φ shows the viewing direction for LCD. / Φ 是LCD的平面角度
- | | | |
|---|------------------|--------|
| Viewing direction is at 12:00 o' clock if $\Phi=90^\circ$ | $\Phi=90^\circ$ | 对应于12点 |
| Viewing direction is at 6:00 o' clock if $\Phi=270^\circ$ | $\Phi=270^\circ$ | 对应于6点 |
| Viewing direction is at 3:00 o' clock if $\Phi=0^\circ$ | $\Phi=0^\circ$ | 对应于3点 |
| Viewing direction is at 9:00 o' clock if $\Phi=180^\circ$ | $\Phi=180^\circ$ | 对应于9点 |

[Note 6]注6

Definition and Measurement Condition of Contrast Ratio /对比度的定义和测量条件

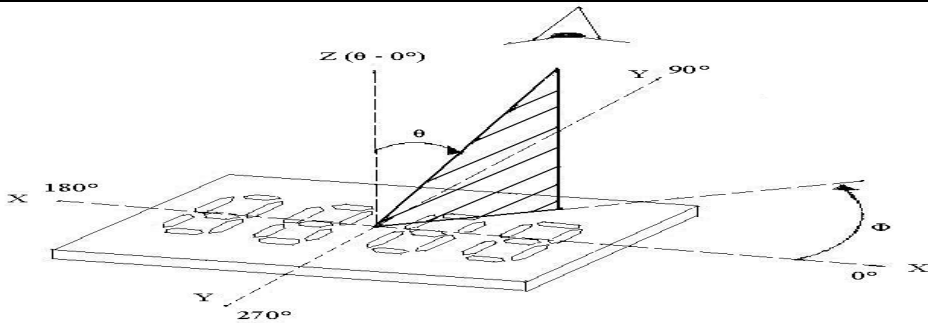
Definition定义:

Contrast Ratio/对比度 (Cr) = Brightness under non-selected wave form/Brightness under selected wave form
 非选时的亮度/选择时的亮度

8. Electrical Characteristics (VSS=0V, VDD=4.5V:TOPR=25°C)

Item	Symbol	Condition	Min.	Typ.	Max.	Unit
Operating voltage	VDD	Ta=25°C	4	4.5	5.5	V
Operating voltage for LCD	V0	Ta=25°C	4	4.5	5.5	V
Operating Current	Idd	Ta=25°C	--	70	--	uA

9. Timing Characteristics

WRITE MODE TIMING DIAGRAM

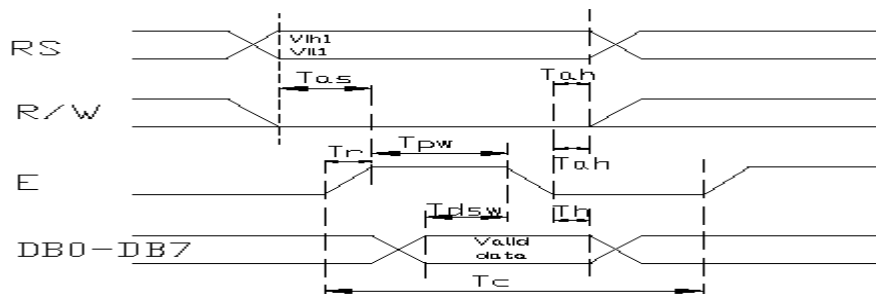



READ MODE TIMING DIAGRAM

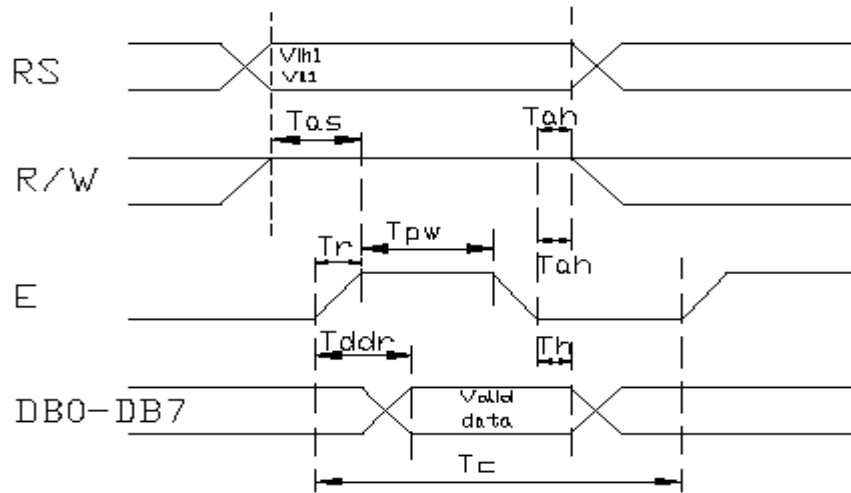

AC CHARACTERISTICS (V_{dd}=5.0V ± 5%, V_{ss}=0V, T_a=25°C)

(Write mode)

Characteristic	Symbol	Min.	Typ.	Max.	Unit
E Cycle Time	T _c	500	--	--	ns
E Rise/Fall Time	T _r ,T _f	--	--	25	ns
E Pulse Width (High, Low)	T _{pw}	220	--	--	ns
R/W and RS Set-up Time	T _{as}	40	--	--	ns
R/W and RS Hold Time	T _{ah}	10	--	--	ns
Data Set-up Time	T _{dsw}	60	--	--	ns
Data Hold Time	T _h	10	--	--	ns

(Read mode)

Characteristic	Symbol	Min.	Typ.	Max.	Unit
E Cycle Time	T _c	500	--	--	ns
E Rise/Fall Time	T _r ,T _f	--	--	25	ns
E Pulse Width (High, Low)	T _{pw}	220	--	--	ns
R/W and RS Set-up Time	T _{as}	40	--	--	ns
R/W and RS Hold Time	T _{ah}	10	--	--	ns
Data Set-up Time	T _{ddr}	--	--	120	ns
Data Hold Time	T _h	20	--	--	ns



10. Command Description

Command	RS	R/W	DB7	DB6	DB5	DB4	DB3	DB2	DB1	DB0	Remark
Display Clear	L	L	L	L	L	L	L	L	L	H	Write "20H" to DDRAM and set DDRAM address to "00H" from AC.
Return Home	L	L	L	L	L	L	L	L	H	X	Cursor move to first digit
Entry Mode Set	L	L	L	L	L	L	L	H	I/D	SH	I/D: Set cursor move direction H-Increase L-Decrease SH: Specifies shift of display H-Display is shifted L-Display is not shifted
Display On/Off Control	L	L	L	L	L	L	H	D	C	B	D: Display (H-on, L-off) C: Cursor (H-on, L-off) B: Blinking (H-on, L-off)
Shift	L	L	L	L	L	H	S/C	R/L	X	X	SC:(H-Display shift, L-Cursor move) R/L:(H-Right shift, L-Left shift)
Set Function	L	L	L	L	H	DL	N	F	X	X	DL:(H-8 bits interface, L-4 bits interface) N:(H-2 line display, L-1 line display) F:(H-5 x 10 dots, L-5 x 7 dots)
Set CGRAM Address	L	L	L	H	CG RAM address (Corresponds to address)					CGRAM data is sent and received after this setting	
Set DDRAM Address	L	L	H	DD RAM address					DDRAM data is sent and received after this setting		
Read Busy Flag & Address	L	H	BF	Address Counter used for Both DD & CGRAM address					BF:(H-Busy, L-Ready) --Reads BF indication Internal operating is being performed --Reads address counter contents		
Write Data to RAM	H	L	Write Data					Write data into DDRAM or CGRAM			
Read Data from RAM	H	H	Read Data					Read data from DDRAM or CGRAM			

"X": Don't Care



11.CHARACTER FONT TABLE

NO.7066-0B

b7-b4 b3-b0	0000	0001	0010	0011	0100	0101	0110	0111	1000	1001	1010	1011	1100	1101	1110	1111
0000	CG RAM (1)	±	∅	⊙	⊖	⊗	⊘	⊙	⊖	⊗	⊘	⊙	⊖	⊗	⊘	⊙
0001	(2)	≡	!	1	A	Q	a	9	0	æ	ı	ı	J	†	y	U
0010	(3)	7	"	2	B	R	b	r	e	E	ó	ı	o	é	è	æ
0011	(4)	¿	#	3	C	S	c	s	À	á	á	ı	ı	ı	ı	ı
0100	(5)	ı	\$	4	D	T	d	t	à	á	ı	ı	ı	ı	ı	ı
0101	(6)	ı	%	5	E	U	e	u	â	á	ı	ı	ı	ı	ı	ı
0110	(7)	ı	&	6	F	V	f	v	ä	á	ı	ı	ı	ı	ı	ı
0111	(8)	ı	'	7	G	W	g	w	å	á	ı	ı	ı	ı	ı	ı
1000	(1)	ı	(8	H	X	h	x	ê	á	ı	ı	ı	ı	ı	ı
1001	(2)	ı)	9	I	Y	i	y	ë	á	ı	ı	ı	ı	ı	ı
1010	(3)	ı	*	:	J	Z	j	z	è	á	ı	ı	ı	ı	ı	ı
1011	(4)	ı	+	;	K	C	k	c	ı	ı	ı	ı	ı	ı	ı	ı
1100	(5)	ı	,	<	L	\	l	ı	ı	ı	ı	ı	ı	ı	ı	ı
1101	(6)	ı	-	=	M]	m	ı	ı	ı	ı	ı	ı	ı	ı	ı
1110	(7)	ı	.	>	N	^	n	ı	ı	ı	ı	ı	ı	ı	ı	ı
1111	(8)	ı	/	?	O	_	o	ı	ı	ı	ı	ı	ı	ı	ı	ı



12. Reliability

NO	Test Item	Description	Test Condition	Remark
1	Environmental Test	High Temperature Storage Applying the high storage temperature Under normal humidity for a long time Check normal performance.	60°C 240H	
2		Low Temperature Storage Applying the low storage temperature Under normal humidity for a long time Check normal performance.	-10°C 240H	
3		High Temperature Operation Apply the electric stress (Voltage & current) under high temperature for a Long time.	50°C 240H	#1
4		Low Temperature Operation Apply the electric stress under low Temperature for a long time	0°C 240H	#1 #2
5		High Temperature/High Humidity storage Apply high temperature and high Humidity storage for a long time	95%RH 50°C 240H	#2
6		Temperature Cycle Apply the low and high temperature cycle 30 min 30 min 30 min 30 min 25°C<->55°C(1H)<->25°C(1H)<->-10°C (1H)<->25°C(1H) ←-----> 1 cycle Check normal performance	-10°C/55°C 10 cycle	
7	Mechanical Test	Vibration test (Package state) Applying vibration to the product Check normal performance	Freq.: 10-55Hz Max. Acceleration: 5G X.Y.X. each direction For 10 mines.	
8		Shock Test (Package State) Applying shock to the product Check normal performance	Drop them through 70cm height to strike horizontal plane	

Remark:

#1: Normal operations condition

- a. Power supply for LCD driver voltage
- b. Power supply voltage for LCD system: Getting optimum contrast at 25°C

#2: Pay attention to keep dewdrops from the module during this test.



13. Specification of Quality Assurance

1. Acceptable Quality Level

Each lot should be satisfied the quality level defined as follows.

-Inspection method; MIL-STD-105E level II Normal One Time sampling.

-AQL

Partition	AQL	Definition
Major	0.65	Functional defective as Product
Minor	1.0	Satisfy all functions as product but not satisfy cosmetic standard

2. Definition of "LOT"

One lot means the delivery quantity for customer at one time.

3. Conditions of Cosmetic & Functional Inspection

3.1 Environmental Condition

The inspection should be performed at the 1m of height from the LCD module under 2 PCS of 40W white fluorescent lamps (Normal temperature 20~25°C and normal humidity 85±15%RH).

3.2 Inspection Method

The visual check should be performed vertically at more 30cm's distance from the LCD panel.

3.3 Driving Voltage

Operating voltage according to specification.



3.4 Test pattern

Pattern will automatically displayed according to the software.

14. Inspection Criteria

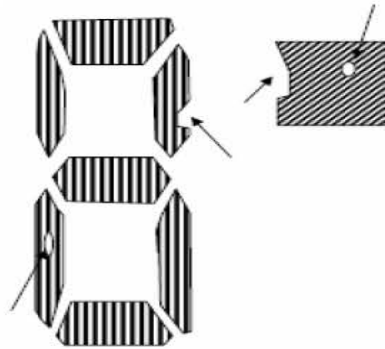
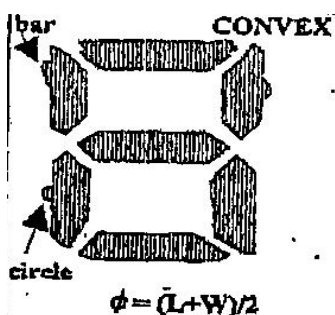
FUNCTION FAILURE

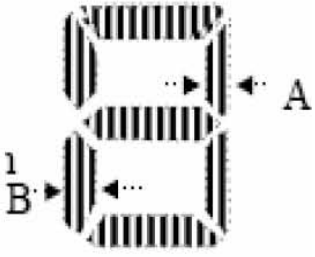
Defect	Define/description	Criteria	
1 open circuit (major)		Reject	
2 short circuit (major)		Reject	
3 dim (major)	According to sample	Reject	
4 ghost (major)	According to sample	Reject	
5 high power consumption (minor)	No exceed spec.	不超过设计要求 According to engineering diagram	
6 针孔, 白点 Pinhole, white spots	针孔, 图白, 图缺 PIN hole 、lack  $\psi = (L+W)/2$		允许个数 acceptable number
		$\psi \leq 0.1 \text{ mm}$	无视(不可密集) disregard(no gathering)
		$0.10\text{mm} < \psi \leq 0.2 \text{ mm}$	3
		(两点距离需 $\geq 5 \text{ mm}$) (The distance between two points $\geq 5\text{mm}$)	
		$0.2\text{mm} < \psi \leq 0.25 \text{ mm}$	2
		$\psi > 0.25\text{mm}$	0
		$\psi > 1/3$ 字节宽 $\psi > 1/3$ width of the character	0
		$0.10 \text{ mm} < \psi \leq 0.25\text{mm}$	3
(单片LCD之总个数需 ≤ 3 个, 两点距离 $\geq 5\text{mm}$). total amount on single LCD sheet ≤ 3 , The distance between two points $\geq 5\text{mm}$			
7.突点: Bar	 $\phi = (L+W)/2$		容许个数 acceptable number
		$\psi > 0.25\text{mm}$	0
		$\psi > 1/3$ 字节宽 $\psi > 1/3$ width of the character	0
		允收之场合, 1个字最多1个, 全部最多3个 Acceptable case: per character, not more than 1; per cell, not more than 3.	

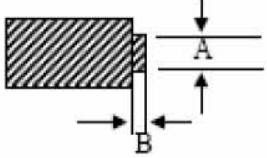
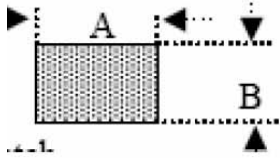
Defect	Define/description	Criteria													
8.組合歪 Assembly not match	 <p style="text-align: center;">$\psi = (L+W)/2$</p>	1. $B - A > 0.25\text{mm}$ 拒收 (reject) 2. $A/B \cong 3/4$ 拒收 (reject) 3. 字体变形比照限度样品验收 Deformed word, examined and accepted according to the limited sample													
9.点阵针孔\缺口 Dot Matrix Pin Hole Lack	<p>Dot Matrix: Pin Hole Lack</p> 	<table border="1"> <thead> <tr> <th>Dimension</th> <th>允许个数 acceptable number</th> </tr> </thead> <tbody> <tr> <td>$\phi \leq 0.1\text{mm}$</td> <td>Disregard</td> </tr> <tr> <td>$0.1\text{mm} < \phi \leq 0.2\text{mm}$ (Distance between two points $\geq 10\text{mm}$)</td> <td>3</td> </tr> <tr> <td>$0.2\text{mm} < \phi \leq 0.25\text{mm}$ (Distance between two points $\geq 20\text{mm}$)</td> <td>2</td> </tr> <tr> <td>$\phi > 0.25\text{mm}$</td> <td>0</td> </tr> <tr> <td>$\phi > 1/3$width of the character</td> <td>0</td> </tr> </tbody> </table>	Dimension	允许个数 acceptable number	$\phi \leq 0.1\text{mm}$	Disregard	$0.1\text{mm} < \phi \leq 0.2\text{mm}$ (Distance between two points $\geq 10\text{mm}$)	3	$0.2\text{mm} < \phi \leq 0.25\text{mm}$ (Distance between two points $\geq 20\text{mm}$)	2	$\phi > 0.25\text{mm}$	0	$\phi > 1/3$ width of the character	0	
Dimension	允许个数 acceptable number														
$\phi \leq 0.1\text{mm}$	Disregard														
$0.1\text{mm} < \phi \leq 0.2\text{mm}$ (Distance between two points $\geq 10\text{mm}$)	3														
$0.2\text{mm} < \phi \leq 0.25\text{mm}$ (Distance between two points $\geq 20\text{mm}$)	2														
$\phi > 0.25\text{mm}$	0														
$\phi > 1/3$ width of the character	0														
10.图凸 CONVEX		1. $A > 0.25\text{mm}$ 2. $B > 0.05\text{mm}$	Reject Reject												
11.点距阵组合歪 Assembly not match	<p>sembly not match(dot-matrix)</p> 	1. A: Distortion square $\leq \pm 0.15\%$ 2. B: Distortion square $\leq \pm 0.15\%$	Accept Accept												
12 显示黑点(黑斑) Black SPOTS	显示时出现点状或斑状更黑的部位 Black spots defect in working	以正常显示时对比不明显, 对比明显时按点状缺陷看 According to Item Spots、Line 、Glass Disrepair Standard													

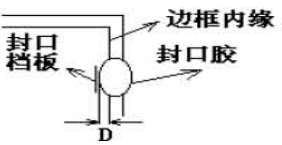
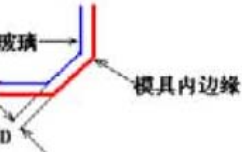

Appearance inspection

Defect	Define/description	Criteria
1. 漏液(主要) 1.leakage (major)	LC	不允许 REJECT
2. 玻璃裂痕(次要) 2. Cracks (minor)	ITO	任何区域的玻璃裂痕不允许 Any crack REJECT
3. 封口宽、高(次要) 3 end sealant over height, over width (minor)		超出在产品资料规定尺寸范围，不允许； According to engineering diagram
4. 封口污染(次要) Permeating resin (minor)		有封口挡板：超出封口挡板不允许； 无封口挡板：D>1.5mm,不允许； Baffle: not overstep baffle no baffle: D>1.5mm, REJECT
5 边框肥大 Seal line larger (minor)		边框均匀肥大：各处边框宽度相差超过1/3不允许；若玻璃边距内边框的距离或内边框进入可视区均不允许； a: greater than 4/3 width of average REJECT b: less than 1/2 width of average REJECT c: seal line enter into A area REJECT
6.彩虹 Rainbow (minor)	Different color in one panel	在规定的视角范围内观察按界限样品判定； 对客户有特殊要求的以双方确认的样板为准； According to the sample
7. ITO底影 Pi coat defect (minor)	Design shows without voltage input	见限度样板 According to the sample
8. 磨角 Cutting defect (minor)		1. 不能装入模或装入模具后D≥0.3 mm不允许 2. 不能超出产品设计值 a: large than mould b: the width of "D" ≥ 0.3MM REJECT c: According to engineering diagram
Defect	Define/description	Criteria
9. 玻璃边麻点 Dirty spot of ito Glass (minor)		边框外的麻点不计边框以内的麻点按03项黑/白 要求判定 a: outside seal expose, disregard b: inside seal expose, according to Spots、Line、Glass Disrepair Standard



10.油墨丝印 Back print (minor)	丝印断线、针孔，凸点起毛 THE POSITION AND APPEARANCE OF THE BACK PRINTING DEFECT	a: 丝印断线，针孔，凸点按点状，线状不良标准 b: 丝印毛边 1/4 丝印宽度 a: BROKEN LINE、PINHOLE、SPOT DEFECT ACCORDING TO Item 6.4.2,6.4.3 b: Width of PRINT EDGE DEFECT OVER 1/4 SPEC REJECT
11.装PIN 脚 Pin defect (min)次要	The size of pin defect	尺寸偏差不超过公差According to engineering diagram
	装PIN 脚歪斜 Pin tilt	$\geq \pm 5^\circ$ 则拒收 ($\geq \pm 5^\circ$ reject)
	少(多)脚断脚(主要)，则不允许0	NUMBER OF PIN DEFECT REJECT
	装PIN 脚胶污染偏光片或渗入偏光片与玻璃之间则不允许	pin glue permeates through polarize and glass or polarize is polluted by pin glue REJECT
	装PIN 脚胶超出上偏光片之高度(次)则拒收； The height of pin glue over the front polarizes. REJECT	
	管脚正面，两脚间无胶不允许； There is no glue between two pins REJECT	
	UV 胶：反面无胶管脚相连数 > 2 脚或同一玻璃无胶缺陷数 ≥ 2 处不允许 UV GLUE: number of the pin which underpants has no glue ≥ 2 REJECT	
	常温胶：管脚反面卡口内无胶不允许 Normal glue: Number of the pin which underpants has no glue ≥ 1 REJECT	
装PIN 脚夹头之间距 Pitch of pins D 标准间距 D spec E 实际间距 E actual	Standard $ D-E < 1/6D$ $1/6D \leq D-E \leq 1/3D$ $ D-E > 1/3D$	Accept 无视 disregard 2 0
12.PCB warped	The excess warped PCB which may affect module assembly	Reject
13.Damaged PCB	The circuit on PCB was scratched or broke	Reject
14. Green paint was taken off on the PCB(the green oil on PCB is un-uniformity or scratched)		Reject
15.Dirty PCB		minor
16.SMT is not in the right position, and the components is too high		Reject
17.The soldering on the PCB is bad (including Back light and Pins)		Reject
18.The label is bad		Reject
19.The protective film is bad		minor

Spots、Line 、Glass Disrepair Standard



Defect	Define/description	Criteria		
1.黑白点 (次要) Spots(minor)		Φ(mm)	普通 normal	
			A	B
		Φ ≤ 0.10	Disregard	Disregard
		0.10 < Φ ≤ 0.15	3	4
		0.15 < Φ ≤ 0.2	2	3
	0.2 < Φ ≤ 0.25	1	2	
2. 玻璃崩边(次要) X 缺陷长度 Y 缺陷宽度 Z 缺陷深度 K1 引线的长度 T 玻璃的厚 Poor cutting (min) X: LENGTH Y: WIDTH Z: DEPTH K1: length of pin ito T: depth of glass		$X \leq 2.0\text{mm}$ $Y \leq K1 / 4$ $Z \leq 1/2T \text{ ACC NO.} \leq 2$ Cluster not acceptable Not allow 2 defects within 10 mm 装管脚的型号: X 的尺寸不计,缺陷数不计 Products with pins disregard		
3.玻璃崩边(次要) X 缺陷长度 Y 缺陷宽度 Z 缺陷深度 K1 引线的长度 T 玻璃的厚		$X \leq 2.0\text{mm}$ $Y \leq K1 / 4$ $Z \leq 1/2T \text{ ACC NO.} \leq 2$ 装管脚的型号: X 的尺寸不计,缺陷数不计 Products with pins disregard		
缺陷数不允许超过 两处		$X \leq 2.0\text{mm}$ $Y \leq \text{边框的外缘及} 1.0\text{mm}$ $Y: \text{not reach the seal line and } 1.0\text{mm}$ $Z \leq 1/2T \text{ ACC NO.} \leq 2$		
		$X \leq 2.0\text{mm}$ $Y \leq \text{边框的外缘及} 1.0\text{mm}$ $Y: \text{not reach the seal line and } 1.0\text{mm}$ $Z \leq 1/2T$		



Defect	Define/description	Criteria			
		X	Y	Z	
4.玻璃崩角(次要) 缺陷数不允许超过两 Corner damage (minor) ACC NO.≤2					
		Large	3	≤K1/3	≤1/2T
	不能有引线被崩掉 Conductive layer broken reject				
5.玻璃突出 (次要) Poor cutting (minor)		1.D≤0.2mm且D ≤K1/4			
		2.according to engineering diagram			
	超出设计尺寸不允许 According to engineering diagram				
6..线状缺陷 (次要) Linear scratch (minor)	1. Not allow 2 defects within 10 mm distance 2. Cluster not acceptable	长L(mm)	宽W(mm)	A area	B area
		Acc	W≤0.02	Ignored	Ignored
		L≤2.0	W≤ 0.04	2	3
7. 偏光片(次要) Polarize defect (minor)	偏光片损伤 Polarizer damage	不允许穿孔，按点状或线状缺陷 a: Polarize strike b:Perforate according to item 1 and 6			
		偏光片须覆盖整个内边框区域且不能超出玻璃窄边边缘不能卷起a: Protuberance at the edge of glass reject b: not cover the seal line reject			
	贴片气泡 Polarizer bubble	尺寸	容许个数		
Φ≤0.2mm		不计			
0.2mm≤Φ≤0.3mm		1			
0.3mm<Φ		0			
Φ ≤0.2mm 之场合每cm2 不超过2个 Number of spots (Φ ≤0.3mm) per cm2 ≤2					

15. Package Specification

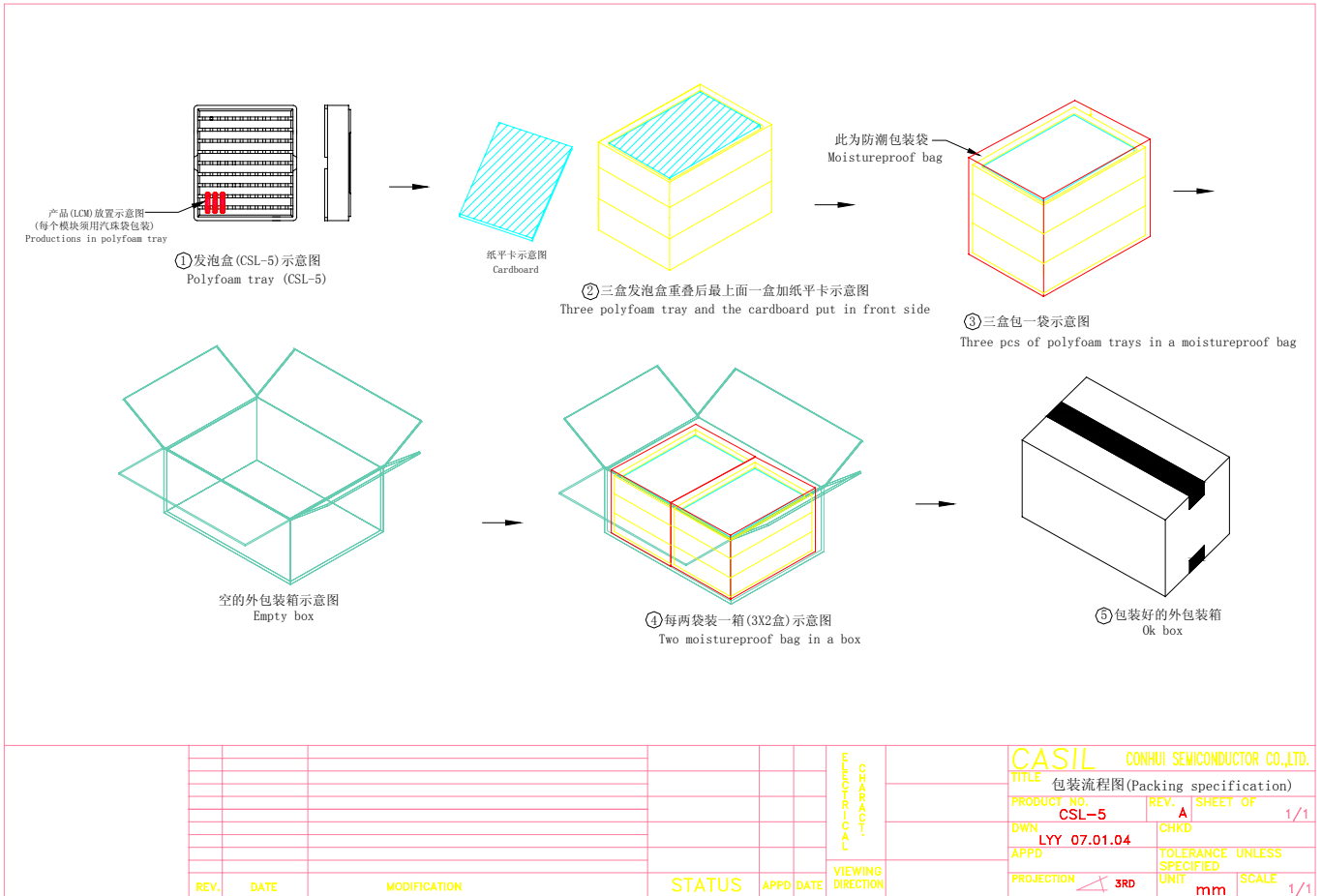

16. Precaution In Use Of LCD Panels & LCM

1.1 Storage

When long-term storage is required, the following precautions are necessary.

- (1) Store them in a sealed polyethylene bag (Antistatic type), seal the opening, and store it where it is not subjected to direct sunshine, or to the light of a fluorescent lamp. If properly sealed, there is no need for desiccant.
- (2) Store them in the temperature range of 0°C -35°C and low humidity is recommended.

1.2 Precaution for handing LCD modules

LCD modules are assembled and adjusted with a high degree of precision, do not applying excessive shocks to it or making any alterations or modifications to it. The following precautions should be taken when



handing.

- (1) Do not drop, bend or bend or twist the module.
- (2) Do not alter or making any modification on the shape of the plastic frame.
- (3) Do not change the shape, the pattern wiring or add any extra hole on the printed circuit board.
- (4) Do not change the positions of components on the PCB.

1.3 Precaution for soldering to LCD module

- (1) Soldering should apply to I/O terminals only.
- (2) Soldering temperature is $280^{\circ}\text{C}\pm 10^{\circ}\text{C}$
- (3) Soldering time 3 to 4 seconds
- (4) Eutectic solder (rosin flux filled) should use.
- (5) If soldering flux is used, be sure to remove any remaining flux after finishing the soldering operation and LCD surface should be covered during soldering to prevent any damage due to flux spatters.
- (6) When removing the lead wires from the I/O terminals, use proper de-soldering methods e.g. suction type-disordering irons. Do not repeat wiring by soldering more than three times as the pads and plated through holes may be damaged.

1.4 Electro-static discharge control

Careful attention should be paid to control the electrostatic discharge of the modules, since LCD modules contain no. Of COMS LSI.

- (1) Make sure you are grounded properly when removing LCD module from its antistatic bag. Be sure that the module and your body have the same electric potential.
- (2) Only properly grounded soldering iron should be used.
- (3) Modules should store in antistatic bag or other containers resistant to static after remove from its original package.
- (4) When using the electric screwdriver is used, make sure the screwdriver had been ground potentiality to minimize the transmission of EM waves produced by commentator sparks.
- (5) In order to reduce the generation of static electricity, a relative humidity of 50-60% is recommended.
- (6) Electrostatic discharge value:4 KV.

1.5 Precaution for operation

- (1) Adjust liquid crystal driving voltage (V_o) to varies viewing angle and obtain the best contrast.
- (2) V_o should be kept in proper range stated in the specification. Excess voltage will shorten the LCD life.
- (3) Response time is greatly delayed at temperatures below the operating temperature range. It will recover when it returns to the specified temperature range.
- (4) If the display area is pushed hard during operation, the display will become abnormal. However, it will return off and then back on.
- (5)** Condensation on terminals can cause an electrochemical reaction disrupting the terminal circuit. Therefore it must be used under the relative condition of 50% RH.



17. Assembly Diagram

PIN	NAME
1	VSS
2	VDD
3	VEE
4	RS
5	RW
6	E1
7	E2
8	NC
9	NC
10	NC
11	DB4
12	DB5
13	DB6
14	DB7
15	A
16	K

NOTE:
 1.DISPLAY TYPE: STN
 2.DISPLAY MODE: YELLOW-GREEN
 3.OPERATING TEMP: 0°C~50°C
 4.STORAGE TEMP: -20°C~70°C
 5.液晶初期R7, R8
 6.DRIVING IC:TWD ST7066U
 AND TWD ST7063C

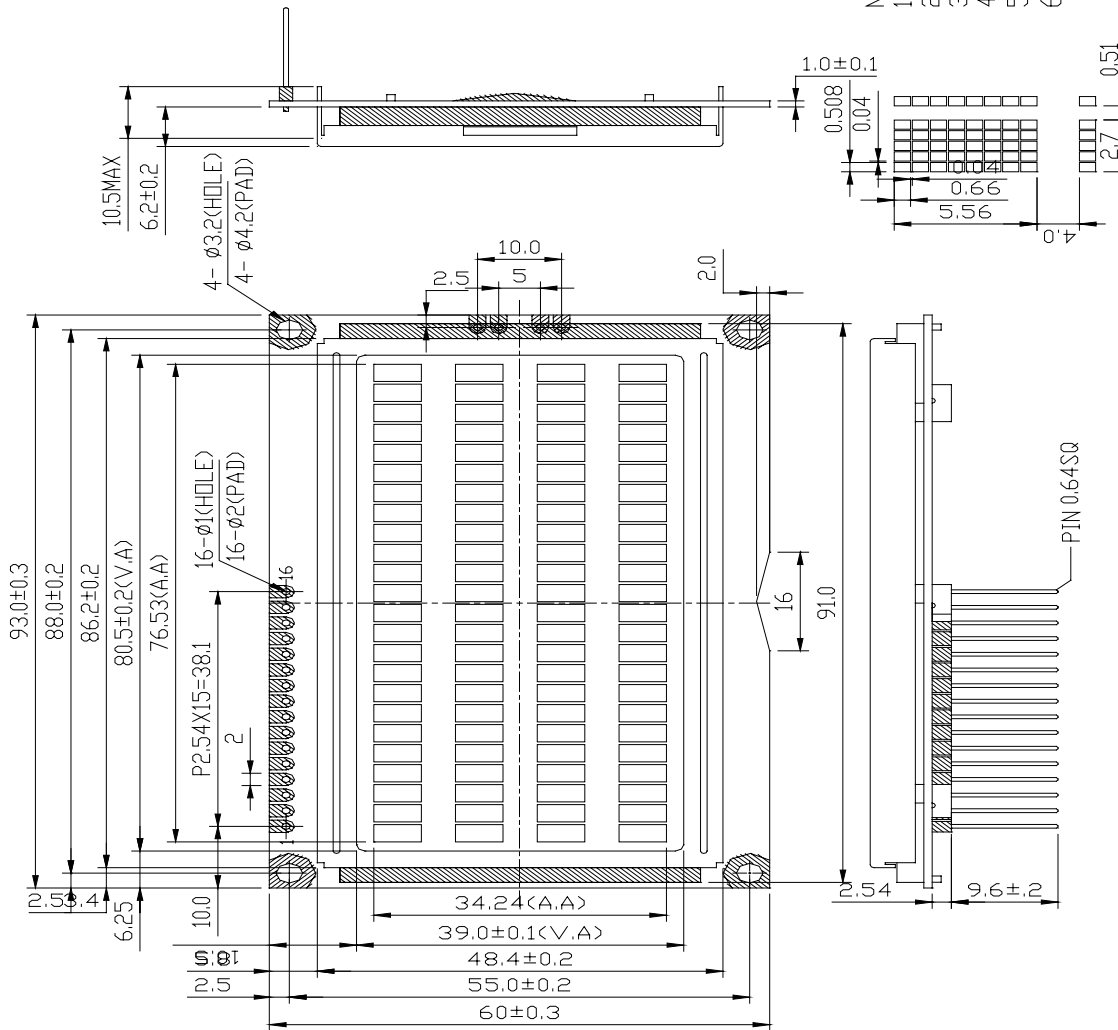

CASIL SEMICONDUCTOR CO., LTD. TITLE: LCM		DUTY CYCLE: 1/16 BLASING: 1/5 OPERATING VOLTAGE: 4.5V	REV. B SHEET OF 1/1 CHKD TOLERANCE UNLESS SPECIFIED: ±0.1
PRODUCT NO. CCM244ICSL-C DWN GCW 2007.12.15 APPD		PROJECTION: 3RD SCALE: 1/1	VIEWING DIRECTION:
CHARACTERISTICS:		STATUS:	APPD DATE:
MODIFICATION: FROM TO DATE: 2007.12.15		DRWN/CHKD/APPD:	APPD DATE:
REV. B	DATE: 2007.12.15	DRWN/CHKD/APPD:	APPD DATE: