

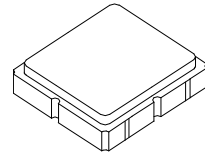

SF1183B

881.5 MHz SAW Filter



SM3030-6

- **RF Filter for Mobile Communication Applications**
- **Low Insertion Loss**
- **3.0 x 3.0 x 1.3 mm Surface-Mount Case**
- **No Matching Circuit Required**

Absolute Maximum Ratings

Rating	Value	Units
Maximum Incident Power in Passband	+10	dBm
Max. DC voltage between any 2 terminals	-5 to +5	VDC
Storage Temperature Range	-40 to +100	°C
Max Soldering Profile	265°C for 10 s	

Electrical Characteristics

Characteristic	Sym	Notes	Min	Typ	Max	Units
Nominal Operating Frequency	f_c	1		881.5		MHz
Passband	IL			2.0	3.0	dB
				1.0	2.0	
Amplitude Ripple p-p across 869-894						dB
Attenuation		1, 2, 3	20	23.0		
			20	30.0		
			23.0	25.0		
			20	24.5		
VSWR across 869-894				1.7	2.5	
Source impedance	Z_S			50		Ω
Load impedance	Z_L			50		Ω
Operating Temperature	T_A	1	-30		+85	°C

Single Ended Input / Output, Impedance match	No matching network required for operation at 50 ohms
Case Style	SM3030-6 3 x 3 mm Nominal Footprint
Lid Symbolization (Y=year, WW=week, S=shift)	449 YWWS

Electrical Connections

Connection	Terminals
Input	2
Output	5
Ground	All others

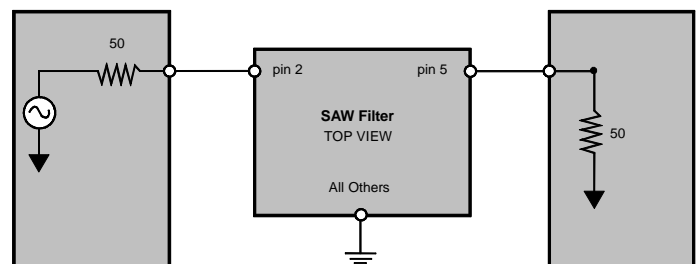

Notes:

1. Unless noted otherwise, all specifications apply over the operating temperature range with filter soldered to the specified demonstration board with impedance matching to 50 Ω and measured with 50 Ω network analyzer.
2. Unless noted otherwise, all frequency specifications are referenced to the nominal center frequency, f_c .
3. Rejection is measured as attenuation below the minimum IL point in the passband. Rejection in final user application is dependent on PCB layout and external impedance matching design. See Application Note No. 42 for details.
4. "LRIP" or "L" after the part number indicates "low rate initial production" and "ENG" or "E" indicates "engineering prototypes."
5. The design, manufacturing process, and specifications of this filter are subject to change.
6. Either Port 1 or Port 2 may be used for either input or output in the design. However, impedances and impedance matching may vary between Port 1 and Port 2, so that the filter must always be installed in one direction per the circuit design.
7. US and international patents may apply.
8. RFM, stylized RFM logo, and RF Monolithics, Inc. are registered trademarks of RF Monolithics, Inc.
9. ©Copyright 1999, RF Monolithics Inc.
10. Electrostatic Sensitive Device. Observe precautions for handling.



Frequency Characteristics

wideband response:

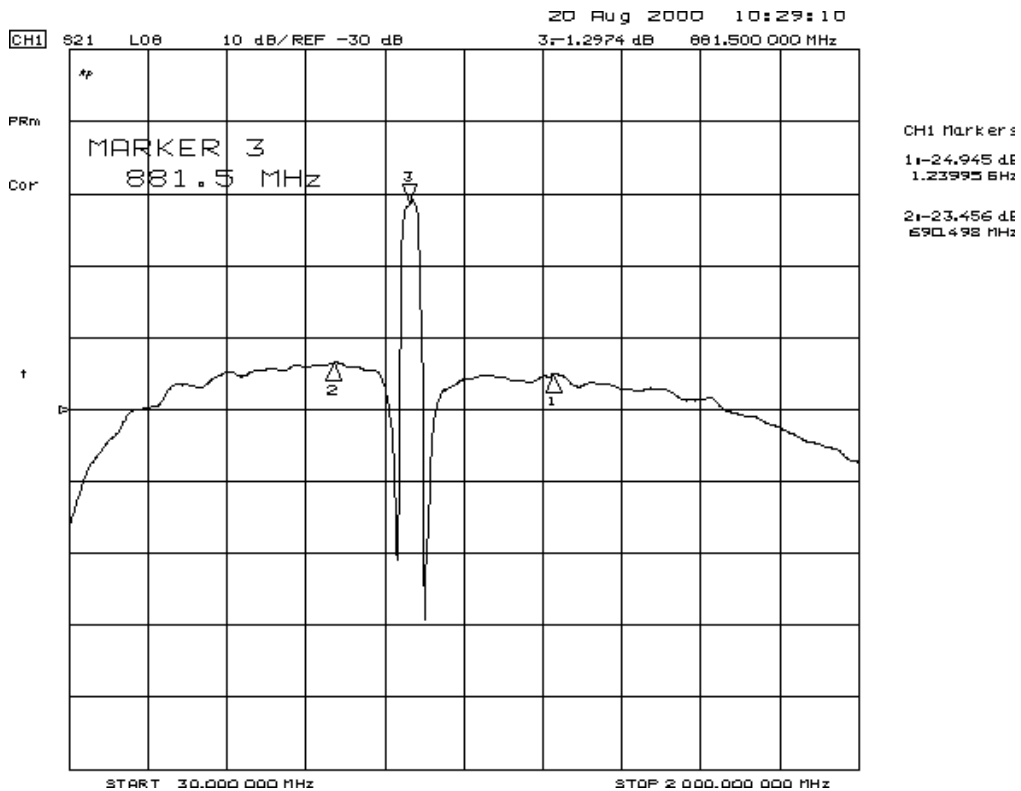
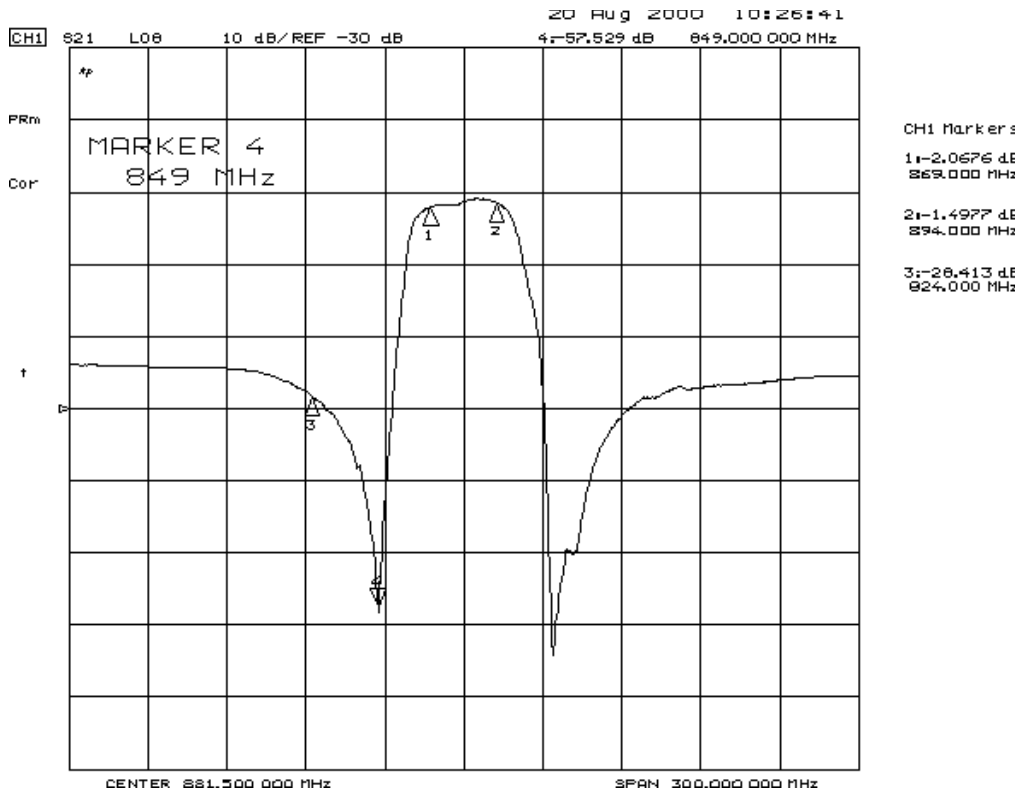

Reflections Functions:

S11 VSWR

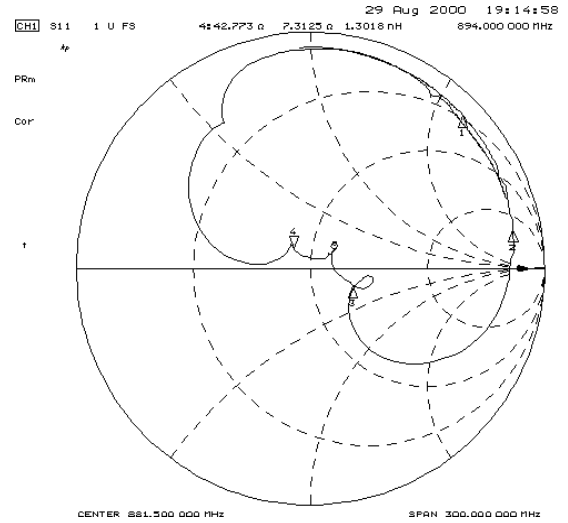
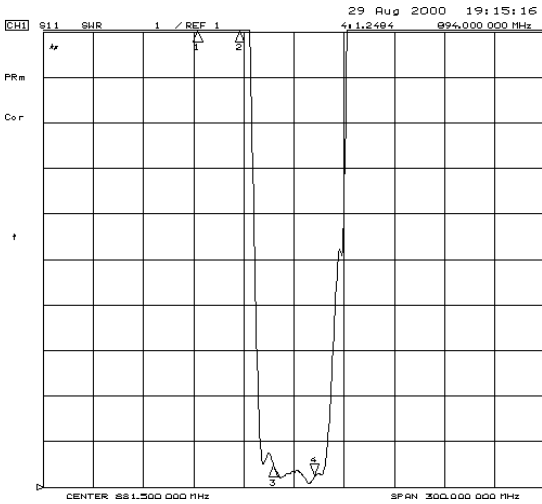

S22 VSWR

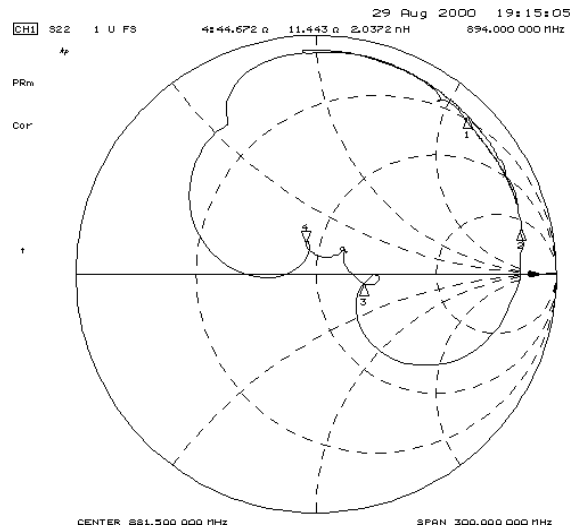
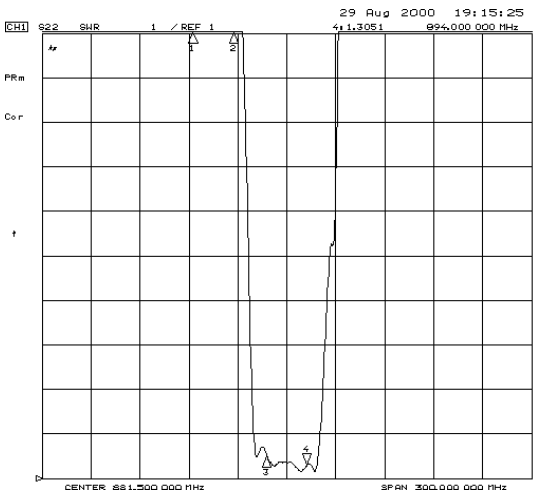

Tape and Reel Specifications

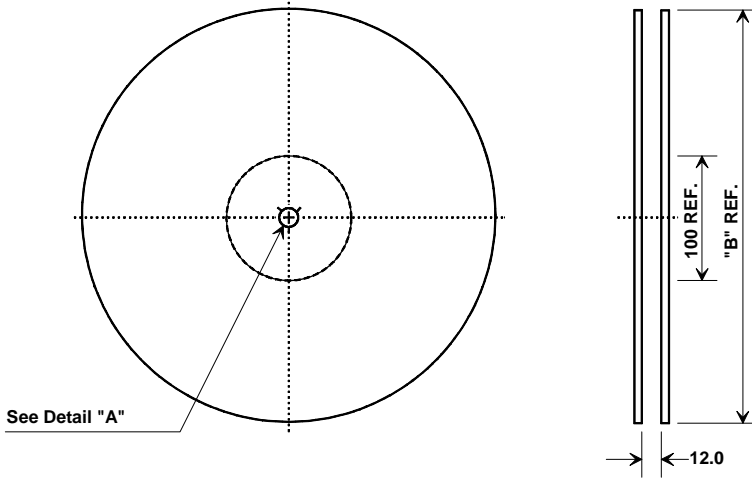

"B "		Quantity Per Reel
Inches	millimeters	
7	178	500
13	330	2000

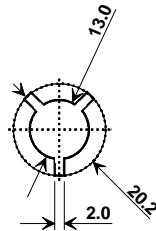

COMPONENT ORIENTATION

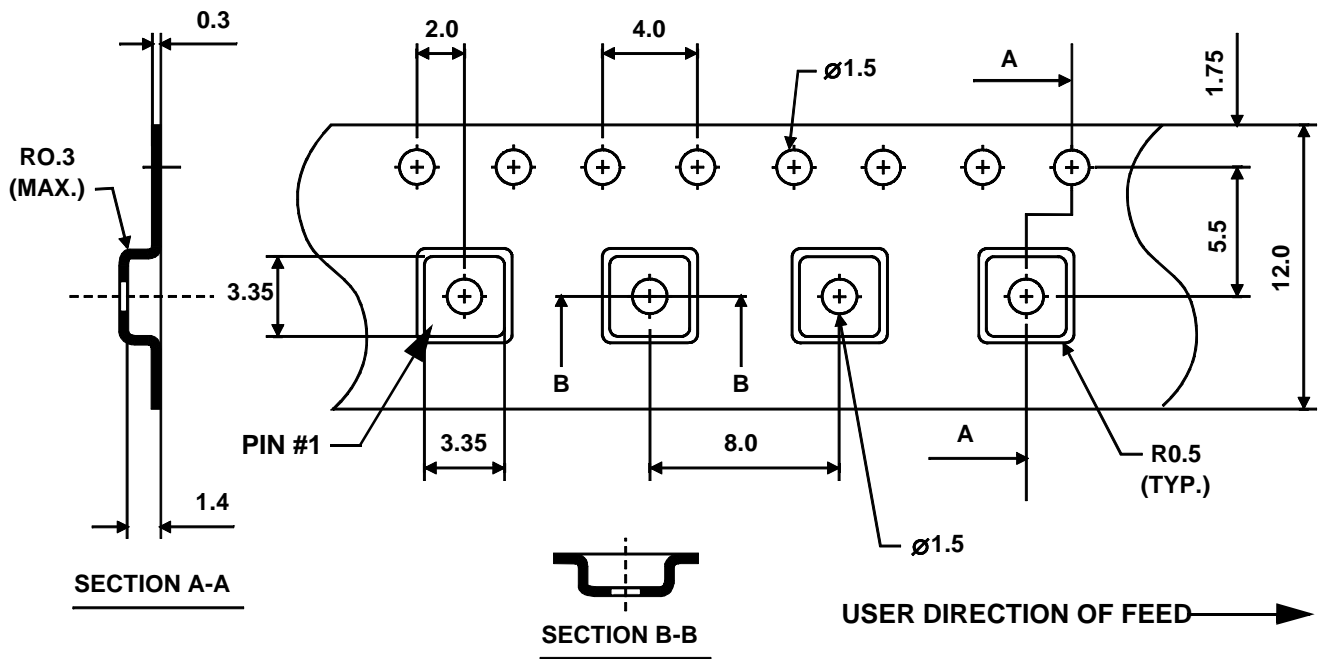

SM3030-6 Case

6-Terminal Ceramic Surface-Mount Case
3.0 X 3.0 mm Nominal Footprint

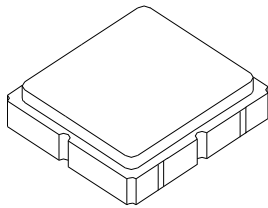

Case Dimensions

Dimension	mm			Inches		
	Min	Nom	Max	Min	Nom	Max
A		3.0			0.118	
B		3.0			0.118	
C		1.3			0.051	
D		0.9			0.035	
E		2.54			0.100	
F		1.6			0.063	
G		0.85			0.033	
H		1.5			0.059	
I		0.6			0.024	
J		1.3			0.051	

Electrical Connections

Connection		Terminals
Port 1	Single Ended Input	2
Port 2	Single Ended Output	5
	Ground	All others
Single Ended Operation Only		
Dot indicates Pin 1		

TOP VIEW

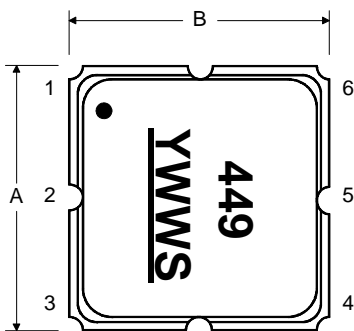

BOTTOM VIEW

