

128K x 36 and 256K x 18 Bit Pipelined BurstRAM Synchronous Fast Static RAM

MCM63P736
MCM63P818

The MCM63P736 and MCM63P818 are 4M-bit synchronous fast static RAMs designed to provide a burstable, high performance, secondary cache for the PowerPC™ and other high performance microprocessors. The MCM63P736 is organized as 128K words of 36 bits each, and the MCM63P818 is organized as 256K words of 18 bits each. These devices integrate input registers, an output register, a 2-bit address counter, and high speed SRAM onto a single monolithic circuit for reduced parts count in cache data RAM applications. Synchronous design allows precise cycle control with the use of an external clock (K).

Addresses (SA), data inputs (DQx), and all control signals except output enable (\overline{G}), sleep mode (ZZ), and linear burst order (\overline{LBO}) are clock (K) controlled through positive-edge-triggered noninverting registers.

Bursts can be initiated with either ADSP or ADSC input pins. Subsequent burst addresses can be generated internally by the MCM63P736 and MCM63P818 (burst sequence operates in linear or interleaved mode dependent upon the state of \overline{LBO}) and controlled by the burst address advance (\overline{ADV}) input pin.

Write cycles are internally self-timed and are initiated by the rising edge of the clock (K) input. This feature eliminates complex off-chip write pulse generation and provides increased timing flexibility for incoming signals.

Synchronous byte write (\overline{SBx}), synchronous global write (\overline{SGW}), and synchronous write enable (\overline{SW}) are provided to allow writes to either individual bytes or to all bytes. The bytes are designated as "a", "b", etc. \overline{SBa} controls DQa, \overline{SBb} controls DQb, etc. Individual bytes are written if the selected byte writes \overline{SBx} are asserted with \overline{SW} . All bytes are written if either \overline{SGW} is asserted or if all \overline{SBx} and \overline{SW} are asserted.

For read cycles, pipelined SRAMs output data is temporarily stored by an edge-triggered output register and then released to the output buffers at the next rising edge of clock (K).

The MCM63P736 and MCM63P818 operate from a 3.3 V core power supply and all outputs operate on a 2.5 V or 3.3 V power supply. All inputs and outputs are JEDEC standard JESD8-5 compatible.

- MCM63P736/MCM63P818-133 = 4 ns Access/7.5 ns Cycle (133 MHz)
- MCM63P736/MCM63P818-100 = 5 ns Access/10 ns Cycle (100 MHz)
- MCM63P736/MCM63P818-66 = 7 ns Access/15 ns Cycle (66 MHz)
- 3.3 V + 10%, - 5% Core Power Supply, 2.5 V or 3.3 V I/O Supply
- \overline{ADSP} , \overline{ADSC} , and \overline{ADV} Burst Control Pins
- Selectable Burst Sequencing Order (Linear/Interleaved)
- Two-Cycle Deselect Timing
- Internally Self-Timed Write Cycle
- Byte Write and Global Write Control
- Sleep Mode (ZZ)
- JEDEC Standard 100-Pin TQFP and 119-Pin PBGA Packages

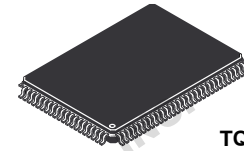

TQ PACKAGE
TQFP
CASE 983A-01

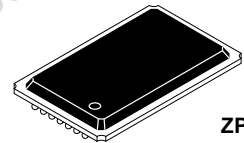

ZP PACKAGE
PBGA
CASE 999-02

The PowerPC name is a trademark of IBM Corp., used under license therefrom.

REV 3
3/12/99



Freescale Semiconductor, Inc.

FUNCTIONAL BLOCK DIAGRAM

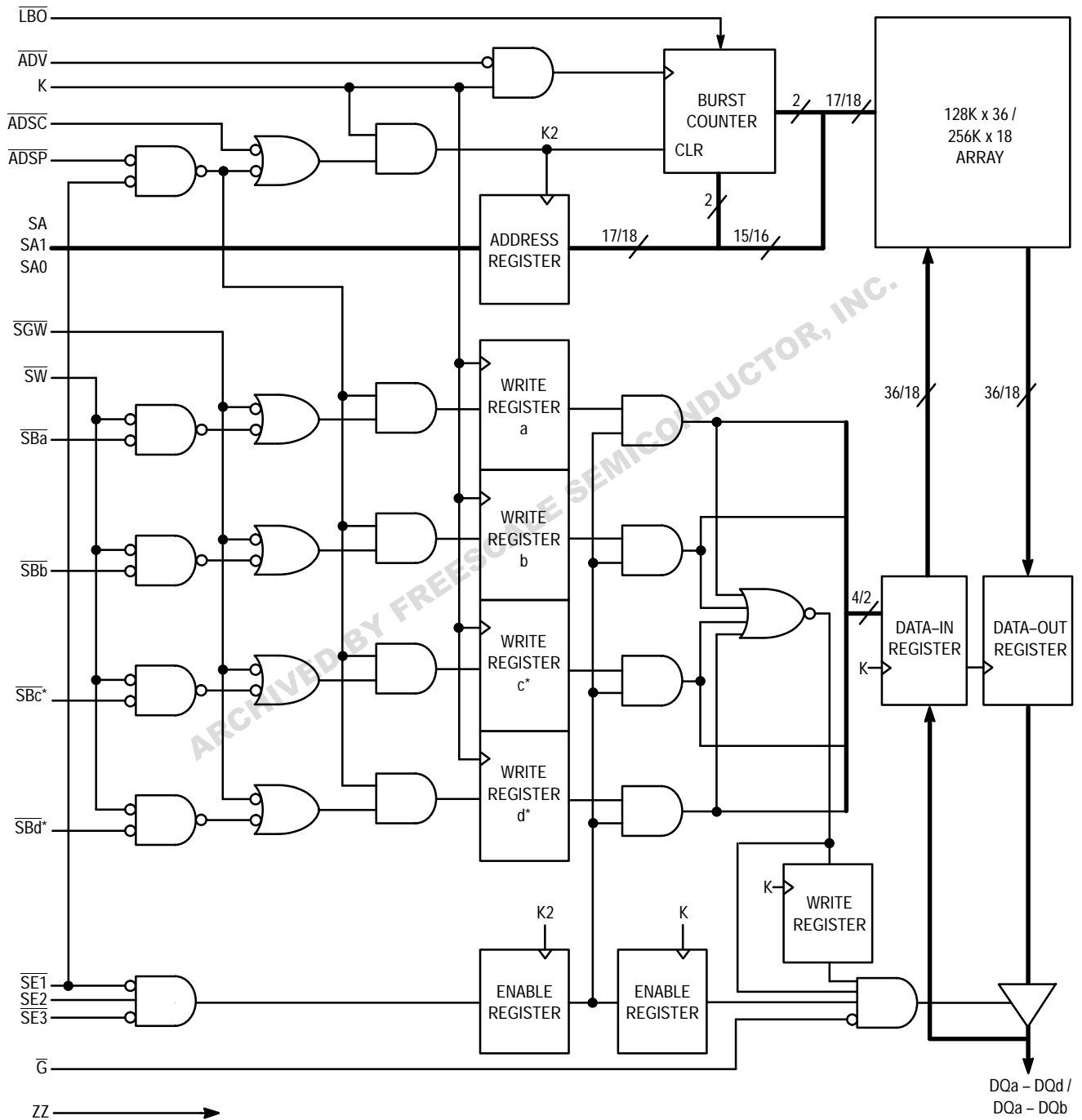

* Valid only for MCM63P736.

Freescale Semiconductor, Inc.

MCM63P736 PIN ASSIGNMENTS

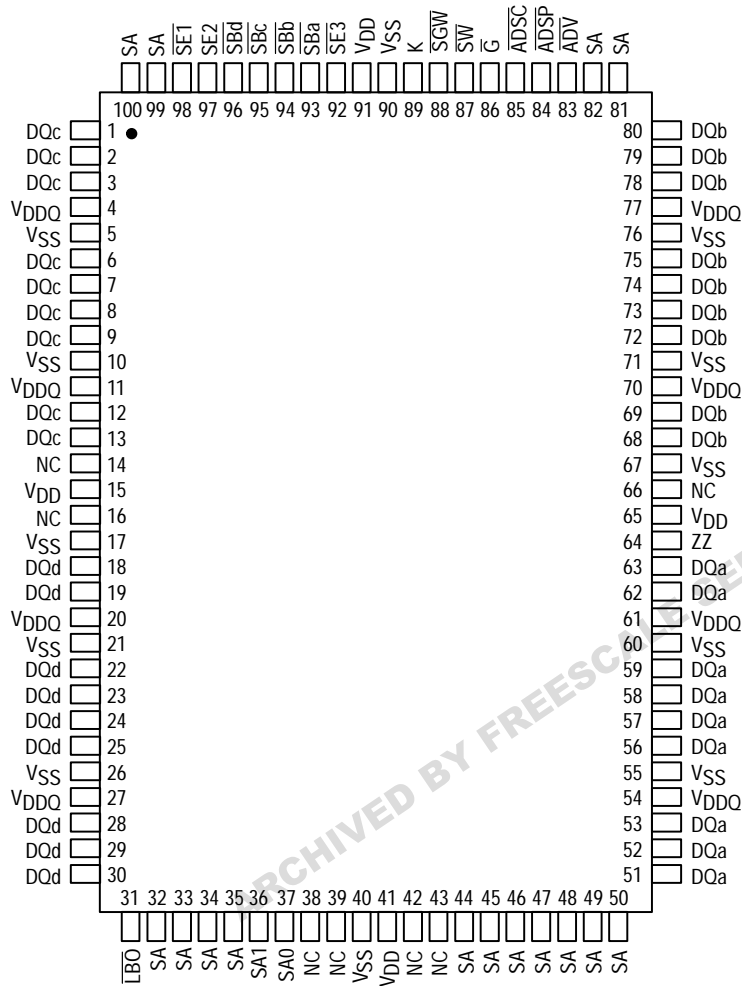

**100-PIN TQFP
TOP VIEW**

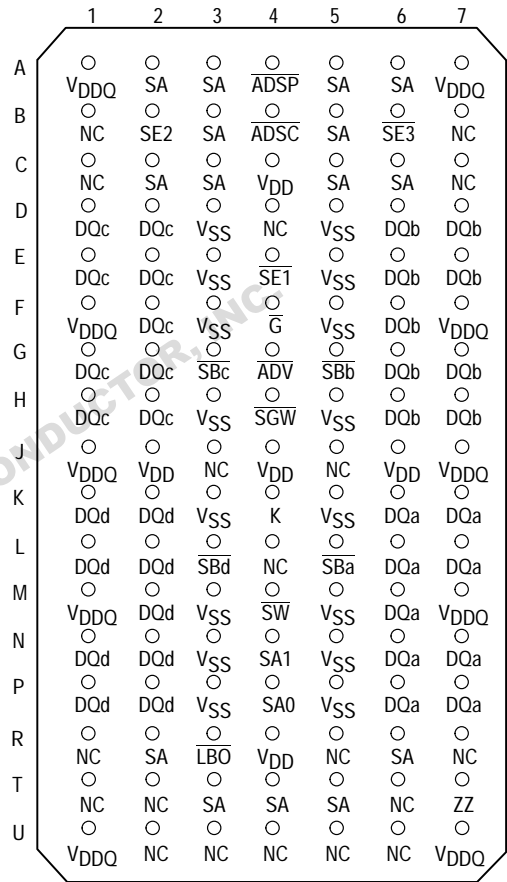

**119-BUMP PBGA
TOP VIEW**

Not to Scale

Freescale Semiconductor, Inc.

MCM63P736 TQFP PIN DESCRIPTIONS

Pin Locations	Symbol	Type	Description
85	\overline{ADSC}	Input	Synchronous Address Status Controller: Active low, interrupts any ongoing burst and latches a new external address. Used to initiate a READ, WRITE, or chip deselect.
84	\overline{ADSP}	Input	Synchronous Address Status Processor: Active low, interrupts any ongoing burst and latches a new external address. Used to initiate a new READ, WRITE, or chip deselect (exception — chip deselect does not occur when ADSP is asserted and SE1 is high).
83	\overline{ADV}	Input	Synchronous Address Advance: Increments address count in accordance with counter type selected (linear/interleaved).
(a) 51, 52, 53, 56, 57, 58, 59, 62, 63 (b) 68, 69, 72, 73, 74, 75, 78, 79, 80 (c) 1, 2, 3, 6, 7, 8, 9, 12, 13 (d) 18, 19, 22, 23, 24, 25, 28, 29, 30	DQx	I/O	Synchronous Data I/O: "x" refers to the byte being read or written (byte a, b, c, d).
86	\overline{G}	Input	Asynchronous Output Enable Input: Low — enables output buffers (DQx pins). High — DQx pins are high impedance.
89	K	Input	Clock: This signal registers the address, data in, and all control signals except \overline{G} , LBO, and ZZ.
31	\overline{LBO}	Input	Linear Burst Order Input: This pin must remain in steady state (this signal not registered or latched). It must be tied high or low. Low — linear burst counter (68K/PowerPC). High — interleaved burst counter (486/i960/Pentium).
32, 33, 34, 35, 44, 45, 46, 47, 48, 49, 50, 81, 82, 99, 100	SA	Input	Synchronous Address Inputs: These inputs are registered and must meet setup and hold times.
36, 37	SA1, SA0	Input	Synchronous Address Inputs: these pins must be wired to the two LSBs of the address bus for proper burst operation. These inputs are registered and must meet setup and hold times.
93, 94, 95, 96 (a) (b) (c) (d)	\overline{SBx}	Input	Synchronous Byte Write Inputs: "x" refers to the byte being written (byte a, b, c, d). SGW overrides SBx.
98	$\overline{SE1}$	Input	Synchronous Chip Enable: Active low to enable chip. Negated high — blocks \overline{ADSP} or deselects chip when \overline{ADSC} is asserted.
97	SE2	Input	Synchronous Chip Enable: Active high for depth expansion.
92	$\overline{SE3}$	Input	Synchronous Chip Enable: Active low for depth expansion.
88	\overline{SGW}	Input	Synchronous Global Write: This signal writes all bytes regardless of the status of the \overline{SBx} and \overline{SW} signals. If only byte write signals \overline{SBx} are being used, tie this pin high.
87	\overline{SW}	Input	Synchronous Write: This signal writes only those bytes that have been selected using the byte write \overline{SBx} pins. If only byte write signals \overline{SBx} are being used, tie this pin low.
64	ZZ	Input	Sleep Mode: This active high asynchronous signal places the RAM into the lowest power mode. The ZZ pin disables the RAMs internal clock when placed in this mode. When ZZ is negated, the RAM remains in low power mode until it is commanded to READ or WRITE. Data integrity is maintained upon returning to normal operation.
15, 41, 65, 91	V _{DD}	Supply	Core Power Supply.
4, 11, 20, 27, 54, 61, 70, 77	V _{DDQ}	Supply	I/O Power Supply.
5, 10, 17, 21, 26, 40, 55, 60, 67, 71, 76, 90	V _{SS}	Supply	Ground.
14, 16, 38, 39, 42, 43, 66	NC	—	No Connection: There is no connection to the chip.

Freescale Semiconductor, Inc.

MCM63P736 PBGA PIN DESCRIPTIONS

Pin Locations	Symbol	Type	Description
4B	\overline{ADSC}	Input	Synchronous Address Status Controller: Active low, interrupts any ongoing burst and latches a new external address. Used to initiate a READ, WRITE, or chip deselect.
4A	\overline{ADSP}	Input	Synchronous Address Status Processor: Active low, interrupts any ongoing burst and latches a new external address. Used to initiate a new READ, WRITE, or chip deselect (exception — chip deselect does not occur when ADSP is asserted and SE1 is high).
4G	\overline{ADV}	Input	Synchronous Address Advance: Increments address count in accordance with counter type selected (linear/interleaved).
(a) 6K, 7K, 6L, 7L, 6M, 6N, 7N, 6P, 7P (b) 6D, 7D, 6E, 7E, 6F, 6G, 7G, 6H, 7H (c) 1D, 2D, 1E, 2E, 2F, 1G, 2G, 1H, 2H (d) 1K, 2K, 1L, 2L, 2M, 1N, 2N, 1P, 2P	DQx	I/O	Synchronous Data I/O: "x" refers to the byte being read or written (byte a, b, c, d).
4F	\overline{G}	Input	Asynchronous Output Enable Input: Low — enables output buffers (DQx pins). High — DQx pins are high impedance.
4K	K	Input	Clock: This signal registers the address, data in, and all control signals except \overline{G} , LBO, and ZZ.
3R	\overline{LBO}	Input	Linear Burst Order Input: This pin must remain in steady state (this signal not registered or latched). It must be tied high or low. Low — linear burst counter (68K/PowerPC). High — interleaved burst counter (486/i960/Pentium).
2A, 3A, 5A, 6A, 3B, 5B, 2C, 3C, 5C, 6C, 2R, 6R, 3T, 4T, 5T	SA	Input	Synchronous Address Inputs: These inputs are registered and must meet setup and hold times.
4N, 4P	SA1, SA0	Input	Synchronous Address Inputs: These pins must be wired to the two LSBs of the address bus for proper burst operation. These inputs are registered and must meet setup and hold times.
5L, 5G, 3G, 3L (a) (b) (c) (d)	\overline{SBx}	Input	Synchronous Byte Write Inputs: "x" refers to the byte being written (byte a, b, c, d). SGW overrides SBx.
4E	$\overline{SE1}$	Input	Synchronous Chip Enable: Active low to enable chip. Negated high — blocks \overline{ADSP} or deselects chip when \overline{ADSC} is asserted.
2B	SE2	Input	Synchronous Chip Enable: Active high for depth expansion.
6B	$\overline{SE3}$	Input	Synchronous Chip Enable: Active low for depth expansion.
4H	\overline{SGW}	Input	Synchronous Global Write: This signal writes all bytes regardless of the status of the \overline{SBx} and \overline{SW} signals. If only byte write signals \overline{SBx} are being used, tie this pin high.
4M	\overline{SW}	Input	Synchronous Write: This signal writes only those bytes that have been selected using the byte write \overline{SBx} pins. If only byte write signals \overline{SBx} are being used, tie this pin low.
7T	ZZ	Input	Sleep Mode: This active high asynchronous signal places the RAM into the lowest power mode. The ZZ pin disables the RAMs internal clock when placed in this mode. When ZZ is negated, the RAM remains in low power mode until it is commanded to READ or WRITE. Data integrity is maintained upon returning to normal operation.
4C, 2J, 4J, 6J, 4R	V _{DD}	Supply	Core Power Supply.
1A, 7A, 1F, 7F, 1J, 7J, 1M, 7M, 1U, 7U	V _{DDQ}	Supply	I/O Power Supply.
3D, 5D, 3E, 5E, 3F, 5F, 3H, 5H, 3K, 5K, 3M, 5M, 3N, 5N, 3P, 5P	V _{SS}	Supply	Ground.
1B, 7B, 1C, 7C, 4D, 3J, 5J, 4L, 1R, 5R, 7R, 1T, 2T, 6T, 2U, 3U, 4U, 5U, 6U	NC	—	No Connection: There is no connection to the chip.

Freescale Semiconductor, Inc.

MCM63P818 PIN ASSIGNMENTS

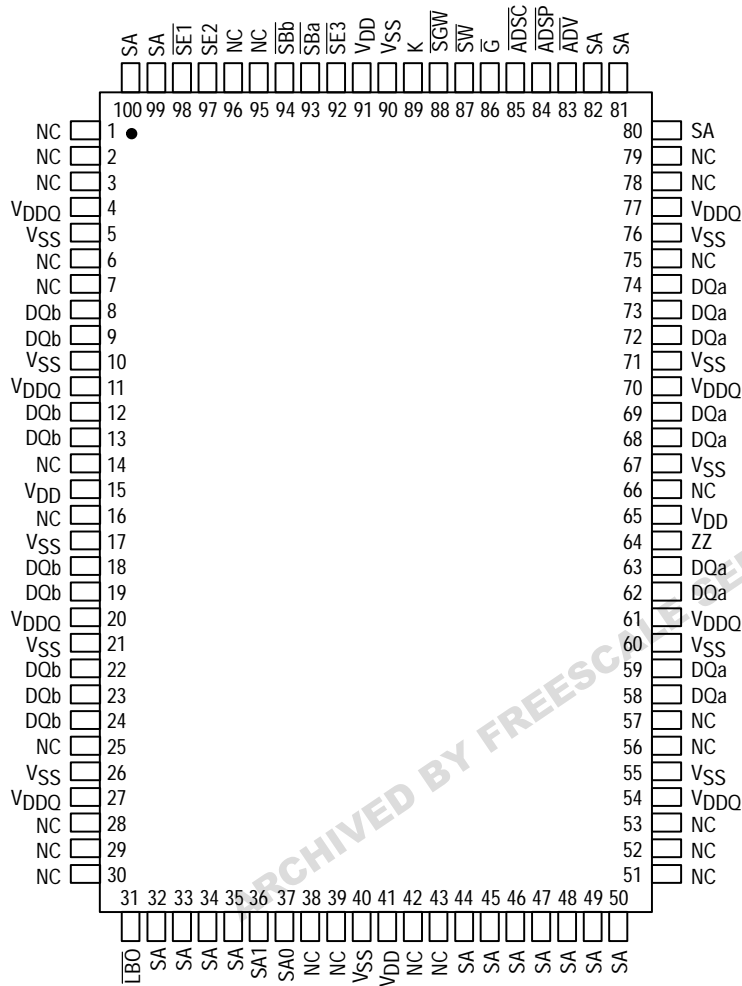

**100-PIN TQFP
TOP VIEW**

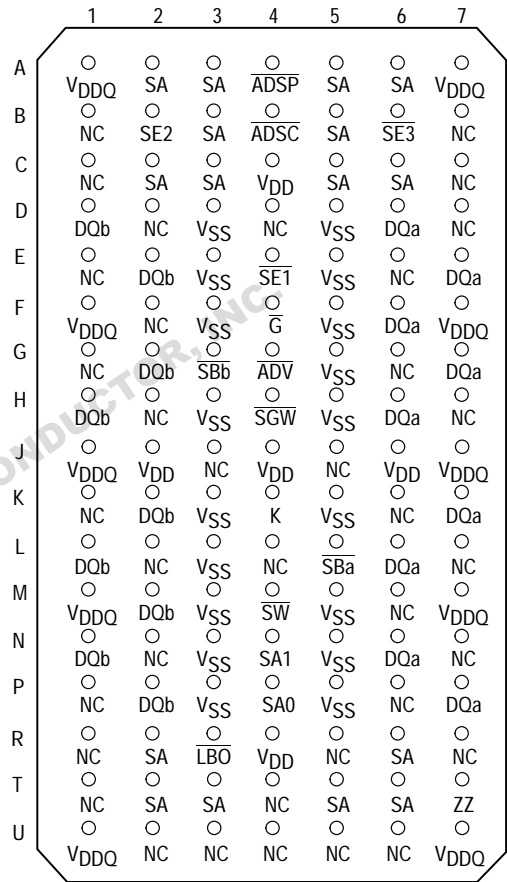

**119-BUMP PBGA
TOP VIEW**

Not to Scale

Freescale Semiconductor, Inc.

MCM63P818 TQFP PIN DESCRIPTIONS

Pin Locations	Symbol	Type	Description
85	\overline{ADSC}	Input	Synchronous Address Status Controller: Active low, interrupts any ongoing burst and latches a new external address. Used to initiate a READ, WRITE, or chip deselect.
84	\overline{ADSP}	Input	Synchronous Address Status Processor: Active low, interrupts any ongoing burst and latches a new external address. Used to initiate a new READ, WRITE, or chip deselect (exception — chip deselect does not occur when ADSP is asserted and SE1 is high).
83	\overline{ADV}	Input	Synchronous Address Advance: Increments address count in accordance with counter type selected (linear/interleaved).
(a) 58, 59, 62, 63, 68, 69, 72, 73, 74 (b) 8, 9, 12, 13, 18, 19, 22, 23, 24	\overline{DQx}	I/O	Synchronous Data I/O: "x" refers to the byte being read or written (byte a, b).
86	\overline{G}	Input	Asynchronous Output Enable Input: Low — enables output buffers (DQx pins). High — DQx pins are high impedance.
89	K	Input	Clock: This signal registers the address, data in, and all control signals except \overline{G} , \overline{LBO} , and ZZ.
31	\overline{LBO}	Input	Linear Burst Order Input: This pin must remain in steady state (this signal not registered or latched). It must be tied high or low. Low — linear burst counter (68K/PowerPC). High — interleaved burst counter (486/i960/Pentium).
32, 33, 34, 35, 44, 45, 46, 47, 48, 49, 50, 80, 81, 82, 99, 100	SA	Input	Synchronous Address Inputs: These inputs are registered and must meet setup and hold times.
36, 37	SA1, SA0	Input	Synchronous Address Inputs: These pins must be wired to the two LSBs of the address bus for proper burst operation. These inputs are registered and must meet setup and hold times.
93, 94 (a) (b)	\overline{SBx}	Input	Synchronous Byte Write Inputs: "x" refers to the byte being written (byte a, b). SGW overrides \overline{SBx} .
98	$\overline{SE1}$	Input	Synchronous Chip Enable: Active low to enable chip. Negated high — blocks \overline{ADSP} or deselects chip when \overline{ADSC} is asserted.
97	SE2	Input	Synchronous Chip Enable: Active high for depth expansion.
92	$\overline{SE3}$	Input	Synchronous Chip Enable: Active low for depth expansion.
88	\overline{SGW}	Input	Synchronous Global Write: This signal writes all bytes regardless of the status of the \overline{SBx} and \overline{SW} signals. If only byte write signals \overline{SBx} are being used, tie this pin high.
87	\overline{SW}	Input	Synchronous Write: This signal writes only those bytes that have been selected using the byte write \overline{SBx} pins. If only byte write signals \overline{SBx} are being used, tie this pin low.
64	ZZ	Input	Sleep Mode: This active high asynchronous signal places the RAM into the lowest power mode. The ZZ pin disables the RAMs internal clock when placed in this mode. When ZZ is negated, the RAM remains in low power mode until it is commanded to READ or WRITE. Data integrity is maintained upon returning to normal operation.
15, 41, 65, 91	V _{DD}	Supply	Core Power Supply.
4, 11, 20, 27, 54, 61, 70, 77	V _{DDQ}	Supply	I/O Power Supply.
5, 10, 17, 21, 26, 40, 55, 60, 67, 71, 76, 90	V _{SS}	Supply	Ground.
1, 2, 3, 6, 7, 14, 16, 25, 28, 29, 30, 38, 39, 42, 43, 51, 52, 53, 56, 57, 66, 75, 78, 79, 95, 96	NC	—	No Connection: There is no connection to the chip.

Freescale Semiconductor, Inc.

MCM63P818 PBGA PIN DESCRIPTIONS

Pin Locations	Symbol	Type	Description
4B	\overline{ADSC}	Input	Synchronous Address Status Controller: Active low, interrupts any ongoing burst and latches a new external address. Used to initiate a READ, WRITE, or chip deselect.
4A	\overline{ADSP}	Input	Synchronous Address Status Processor: Active low, interrupts any ongoing burst and latches a new external address. Used to initiate a new READ, WRITE, or chip deselect (exception — chip deselect does not occur when ADSP is asserted and SE1 is high).
4G	\overline{ADV}	Input	Synchronous Address Advance: Increments address count in accordance with counter type selected (linear/interleaved).
(a) 6D, 7E, 6F, 7G, 6H, 7K, 6L, 6N, 7P (b) 1D, 2E, 2G, 1H, 2K, 1L, 2M, 1N, 2P	DQx	I/O	Synchronous Data I/O: "x" refers to the byte being read or written (byte a, b).
4F	\overline{G}	Input	Asynchronous Output Enable Input: Low — enables output buffers (DQx pins). High — DQx pins are high impedance.
4K	K	Input	Clock: This signal registers the address, data in, and all control signals except \overline{G} , \overline{LBO} , and ZZ.
3R	\overline{LBO}	Input	Linear Burst Order Input: This pin must remain in steady state (this signal not registered or latched). It must be tied high or low. Low — linear burst counter (68K/PowerPC). High — interleaved burst counter (486/i960/Pentium).
2A, 3A, 5A, 6A, 3B, 5B, 2C, 3C, 5C, 6C, 2R, 6R, 2T, 3T, 5T, 6T	SA	Input	Synchronous Address Inputs: These inputs are registered and must meet setup and hold times.
4N, 4P	SA1, SA0	Input	Synchronous Address Inputs: These pins must be wired to the two LSBs of the address bus for proper burst operation. These inputs are registered and must meet setup and hold times.
5L, 3G (a) (b)	\overline{SBx}	Input	Synchronous Byte Write Inputs: "x" refers to the byte being written (byte a, b). SGW overrides \overline{SBx} .
4E	$\overline{SE1}$	Input	Synchronous Chip Enable: Active low to enable chip. Negated high — blocks \overline{ADSP} or deselects chip when \overline{ADSC} is asserted.
2B	SE2	Input	Synchronous Chip Enable: Active high for depth expansion.
6B	$\overline{SE3}$	Input	Synchronous Chip Enable: Active low for depth expansion.
4H	\overline{SGW}	Input	Synchronous Global Write: This signal writes all bytes regardless of the status of the \overline{SBx} and \overline{SW} signals. If only byte write signals \overline{SBx} are being used, tie this pin high.
4M	\overline{SW}	Input	Synchronous Write: This signal writes only those bytes that have been selected using the byte write \overline{SBx} pins. If only byte write signals \overline{SBx} are being used, tie this pin low.
7T	ZZ	Input	Sleep Mode: This active high asynchronous signal places the RAM into the lowest power mode. The ZZ pin disables the RAMs internal clock when placed in this mode. When ZZ is negated, the RAM remains in low power mode until it is commanded to READ or WRITE. Data integrity is maintained upon returning to normal operation.
4C, 2J, 4J, 6J, 4R	V _{DD}	Supply	Core Power Supply.
1A, 7A, 1F, 7F, 1J, 7J, 1M, 7M, 1U, 7U	V _{DDQ}	Supply	I/O Power Supply.
3D, 5D, 3E, 5E, 3F, 5F, 5G, 3H, 5H, 3K, 5K, 3L, 3M, 5M, 3N, 5N, 3P, 5P	V _{SS}	Supply	Ground.
1B, 7B, 1C, 7C, 2D, 4D, 7D, 1E, 6E, 2F, 1G, 6G, 2H, 7H, 3J, 5J, 1K, 6K, 2L, 4L, 7L, 6M, 2N, 7N, 1P, 6P, 1R, 5R, 7R, 1T, 4T, 2U, 3U, 4U, 5U, 6U	NC	—	No Connection: There is no connection to the chip.

Freescale Semiconductor, Inc.

TRUTH TABLE (See Notes 1 Through 5)

Next Cycle	Address Used	$\overline{SE1}$	SE2	$\overline{SE3}$	\overline{ADSP}	\overline{ADSC}	\overline{ADV}	\overline{G}^3	DQx	Write 2, 4
Deselect	None	1	X	X	X	0	X	X	High-Z	X
Deselect	None	0	X	1	0	X	X	X	High-Z	X
Deselect	None	0	0	X	0	X	X	X	High-Z	X
Deselect	None	X	X	1	1	0	X	X	High-Z	X
Deselect	None	X	0	X	1	0	X	X	High-Z	X
Begin Read	External	0	1	0	0	X	X	X	High-Z	X
Begin Read	External	0	1	0	1	0	X	X	High-Z	READ
Continue Read	Next	X	X	X	1	1	0	1	High-Z	READ
Continue Read	Next	X	X	X	1	1	0	0	DQ	READ
Continue Read	Next	1	X	X	X	1	0	1	High-Z	READ
Continue Read	Next	1	X	X	X	1	0	0	DQ	READ
Suspend Read	Current	X	X	X	1	1	1	1	High-Z	READ
Suspend Read	Current	X	X	X	1	1	1	0	DQ	READ
Suspend Read	Current	1	X	X	X	1	1	1	High-Z	READ
Suspend Read	Current	1	X	X	X	1	1	0	DQ	READ
Begin Write	External	0	1	0	1	0	X	X	High-Z	WRITE
Continue Write	Next	X	X	X	1	1	0	X	High-Z	WRITE
Continue Write	Next	1	X	X	X	1	0	X	High-Z	WRITE
Suspend Write	Current	X	X	X	1	1	1	X	High-Z	WRITE
Suspend Write	Current	1	X	X	X	1	1	X	High-Z	WRITE

NOTES:

1. X = Don't Care. 1 = logic high. 0 = logic low.
2. Write is defined as either 1) any \overline{SBx} and SW low or 2) \overline{SGW} is low.
3. \overline{G} is an asynchronous signal and is not sampled by the clock K. \overline{G} drives the bus immediately (t_{GLQX}) following \overline{G} going low.
4. On write cycles that follow read cycles, \overline{G} must be negated prior to the start of the write cycle to ensure proper write data setup times. \overline{G} must also remain negated at the completion of the write cycle to ensure proper write data hold times.

ASYNCHRONOUS TRUTH TABLE

Operation	ZZ	\overline{G}	I/O Status
Read	L	L	Data Out (DQx)
Read	L	H	High-Z
Write	L	X	High-Z
Deselected	L	X	High-Z
Sleep	H	X	High-Z

LINEAR BURST ADDRESS TABLE ($\overline{LB0} = V_{SS}$)

1st Address (External)	2nd Address (Internal)	3rd Address (Internal)	4th Address (Internal)
X...X00	X...X01	X...X10	X...X11
X...X01	X...X10	X...X11	X...X00
X...X10	X...X11	X...X00	X...X01
X...X11	X...X00	X...X01	X...X10

INTERLEAVED BURST ADDRESS TABLE ($\overline{LB0} = V_{DD}$)

1st Address (External)	2nd Address (Internal)	3rd Address (Internal)	4th Address (Internal)
X...X00	X...X01	X...X10	X...X11
X...X01	X...X00	X...X11	X...X10
X...X10	X...X11	X...X00	X...X01
X...X11	X...X10	X...X01	X...X00

WRITE TRUTH TABLE

Cycle Type	\overline{SGW}	\overline{SW}	\overline{SBa}	\overline{SBb}	\overline{SBc} (See Note 1)	\overline{SBd} (See Note 1)
Read	H	H	X	X	X	X
Read	H	L	H	H	H	H
Write Byte a	H	L	L	H	H	H
Write Byte b	H	L	H	L	H	H
Write Byte c (See Note 1)	H	L	H	H	L	H
Write Byte d (See Note 1)	H	L	H	H	H	L
Write All Bytes	H	L	L	L	L	L
Write All Bytes	L	X	X	X	X	X

NOTE:

- Valid only for MCM63P736.

ABSOLUTE MAXIMUM RATINGS (See Note 1)

Rating	Symbol	Value	Unit	Notes
Power Supply Voltage	V_{DD}	$V_{SS} - 0.5$ to 4.6	V	
I/O Supply Voltage	V_{DDQ}	$V_{SS} - 0.5$ to V_{DD}	V	2
Input Voltage Relative to V_{SS} for Any Pin Except V_{DD}	V_{in}, V_{out}	$V_{SS} - 0.5$ to $V_{DD} + 0.5$	V	2
Input Voltage (Three-State I/O)	V_{IT}	$V_{SS} - 0.5$ to $V_{DDQ} + 0.5$	V	2
Output Current (per I/O)	I_{out}	± 20	mA	
Package Power Dissipation	P_D	1.6	W	3
Temperature Under Bias	T_{bias}	- 10 to 85	$^{\circ}C$	
Storage Temperature	T_{stg}	- 55 to 125	$^{\circ}C$	

This device contains circuitry to protect the inputs against damage due to high static voltages or electric fields; however, it is advised that normal precautions be taken to avoid application of any voltage higher than maximum rated voltages to this high-impedance circuit.

NOTES:

- Permanent device damage may occur if ABSOLUTE MAXIMUM RATINGS are exceeded. Functional operation should be restricted to RECOMMENDED OPERATING CONDITIONS. Exposure to higher than recommended voltages for extended periods of time could affect device reliability.
- This is a steady-state DC parameter that is in effect after the power supply has achieved its nominal operating level. Power sequencing is not necessary.
- Power dissipation capability is dependent upon package characteristics and use environment. See Package Thermal Characteristics.

PACKAGE THERMAL CHARACTERISTICS — TQFP

Rating	Symbol	Max	Unit	Notes
Junction to Ambient (@ 200 lfm)	$R_{\theta JA}$	40 25	$^{\circ}C/W$	1, 2
Junction to Board (Bottom)	$R_{\theta JB}$	17	$^{\circ}C/W$	3
Junction to Case (Top)	$R_{\theta JC}$	9	$^{\circ}C/W$	4

NOTES:

- Junction temperature is a function of on-chip power dissipation, package thermal resistance, mounting site (board) temperature, ambient temperature, air flow, board population, and board thermal resistance.
- Per SEMI G38-87.
- Indicates the average thermal resistance between the die and the printed circuit board.
- Indicates the average thermal resistance between the die and the case top surface via the cold plate method (MIL SPEC-883 Method 1012.1).

Freescale Semiconductor, Inc.

PACKAGE THERMAL CHARACTERISTICS — PBGA

Rating	Symbol	Max	Unit	Notes
Junction to Ambient (@ 200 lfm) Single-Layer Board Four-Layer Board	$R_{\theta JA}$	38 22	$^{\circ}C/W$	1, 2
Junction to Board (Bottom)	$R_{\theta JB}$	14	$^{\circ}C/W$	3
Junction to Case (Top)	$R_{\theta JC}$	5	$^{\circ}C/W$	4

NOTES:

1. Junction temperature is a function of on-chip power dissipation, package thermal resistance, mounting site (board) temperature, ambient temperature, air flow, board population, and board thermal resistance.
2. Per SEMI G38-87.
3. Indicates the average thermal resistance between the die and the printed circuit board.
4. Indicates the average thermal resistance between the die and the case top surface via the cold plate method (MIL SPEC-883 Method 1012.1).

DC OPERATING CONDITIONS AND CHARACTERISTICS

($V_{DD} = 3.3\text{ V} + 10\%, -5\%$, $T_A = 0\text{ to }70^{\circ}C$, Unless Otherwise Noted)

RECOMMENDED OPERATING CONDITIONS AND DC CHARACTERISTICS: 2.5 V I/O SUPPLY

(Voltages Referenced to $V_{SS} = 0\text{ V}$)

Parameter	Symbol	Min	Typ	Max	Unit
Supply Voltage	V_{DD}	3.135	3.3	3.6	V
I/O Supply Voltage	V_{DDQ}	2.375	2.5	2.9	V
Input Low Voltage	V_{IL}	-0.3	—	0.7	V
Input High Voltage	V_{IH}	1.7	—	$V_{DD} + 0.3$	V
Input High Voltage I/O Pins	V_{IH2}	1.7	—	$V_{DDQ} + 0.3$	V
Output Low Voltage ($I_{OL} = 2\text{ mA}$)	V_{OL}	—	—	0.7	V
Output High Voltage ($I_{OL} = -2\text{ mA}$)	V_{OH}	1.7	—	—	V

RECOMMENDED OPERATING CONDITIONS AND DC CHARACTERISTICS: 3.3 V I/O SUPPLY

(Voltages Referenced to $V_{SS} = 0\text{ V}$)

Parameter	Symbol	Min	Typ	Max	Unit
Supply Voltage	V_{DD}	3.135	3.3	3.6	V
I/O Supply Voltage	V_{DDQ}	3.135	3.3	V_{DD}	V
Input Low Voltage	V_{IL}	-0.5	—	0.8	V
Input High Voltage	V_{IH}	2	—	$V_{DD} + 0.5$	V
Input High Voltage I/O Pins	V_{IH2}	2	—	$V_{DDQ} + 0.5$	V
Output Low Voltage ($I_{OL} = 8\text{ mA}$)	V_{OL}	—	—	0.4	V
Output High Voltage ($I_{OL} = -4\text{ mA}$)	V_{OH}	2.4	—	—	V

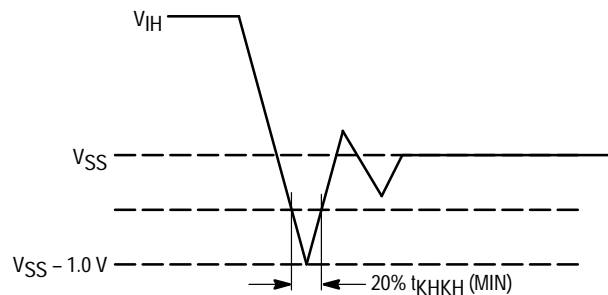

Figure 1. Undershoot Voltage

Freescale Semiconductor, Inc.

SUPPLY CURRENTS

Parameter	Symbol	Min	Typ	Max	Unit	Notes
Input Leakage Current ($0\text{ V} \leq V_{in} \leq V_{DD}$)	$I_{kg(I)}$	—	—	± 1	μA	1
Output Leakage Current ($0\text{ V} \leq V_{in} \leq V_{DDQ}$)	$I_{kg(O)}$	—	—	± 1	μA	
AC Supply Current (Device Selected, All Outputs Open, Freq = Max) Includes V_{DD} Only	I_{DDA}	—	—	450/380 410/345 350/285	mA	2, 3, 4
CMOS Standby Supply Current (Device Deselected, Freq = 0, $V_{DD} = \text{Max}$, All Inputs Static at CMOS Levels)	I_{SB2}	—	—	15	mA	5, 6
Sleep Mode Standby Current (Device Deselected, Freq = Max, $V_{DD} = \text{Max}$, All Other Inputs Static at CMOS Levels, $ZZ \geq V_{DD} - 0.2\text{ V}$)	I_{ZZ}	—	—	5	mA	1, 5, 6
TTL Standby Supply Current (Device Deselected, Freq = 0, $V_{DD} = \text{Max}$, All Inputs Static at TTL Levels)	I_{SB3}	—	—	35	mA	5, 7
Clock Running (Device Deselected, Freq = Max, $V_{DD} = \text{Max}$, All Inputs Toggling at CMOS Levels)	I_{SB4}	—	—	160/145 135/120 110/95	mA	5, 6
Static Clock Running (Device Deselected, Freq = Max, $V_{DD} = \text{Max}$, All Inputs Static at TTL Levels)	I_{SB5}	—	—	65/55 50/40 35/30	mA	5, 6

NOTES:

1. \overline{LBO} and ZZ pins have an internal pull-up and pull-down, respectively; and will exhibit leakage currents of $\pm 5\ \mu\text{A}$.
2. Reference AC Operating Conditions and Characteristics for input and timing.
3. All addresses transition simultaneously low (LSB) then high (MSB).
4. Data states are all zero.
5. Device is deselected as defined by the Truth Table.
6. CMOS levels for I/Os are $V_{IT} \leq V_{SS} + 0.2\text{ V}$ or $\geq V_{DDQ} - 0.2\text{ V}$. CMOS levels for other inputs are $V_{in} \leq V_{SS} + 0.2\text{ V}$ or $\geq V_{DD} - 0.2\text{ V}$.
7. TTL levels for I/Os are $V_{IT} \leq V_{IL}$ or $\geq V_{IH2}$. TTL levels for other inputs are $V_{in} \leq V_{IL}$ or $\geq V_{IH}$.

Freescale Semiconductor, Inc.

AC OPERATING CONDITIONS AND CHARACTERISTICS

(V_{DD} = 3.3 V + 10%, - 5%, T_A = 0 to 70°C, Unless Otherwise Noted)

Input Timing Measurement Reference Level 1.5 V
 Input Pulse Levels 0 to 3.0 V
 Input Rise/Fall Time 1.0 V/ns (20% to 80%)

Output Timing Reference Level 1.5 V
 Output Load See Figure 2 Unless Otherwise Noted

READ/WRITE CYCLE TIMING (See Notes 1 and 2)

Parameter	Symbol	MCM63P736-133 MCM63P818-133		MCM63P736-100 MCM63P818-100		MCM63P737-66 MCM63P819-66		Unit	Notes
		Min	Max	Min	Max	Min	Max		
Cycle Time	t _{KHKH}	7.5	—	10	—	15	—	ns	
Clock High Pulse Width	t _{KHKL}	3	—	4	—	6	—	ns	3
Clock Low Pulse Width	t _{KLKH}	3	—	4	—	6	—	ns	3
Clock Access Time	t _{KHQV}	—	4	—	5	—	7	ns	
Output Enable to Output Valid	t _{GLQV}	—	3.8	—	4	—	6	ns	
Clock High to Output Active	t _{KHQX1}	0	—	0	—	0	—	ns	4, 5
Clock High to Output Change	t _{KHQX2}	1.5	—	1.5	—	1.5	—	ns	4
Output Enable to Output Active	t _{GLQX}	0	—	0	—	0	—	ns	4, 5
Output Disable to Q High-Z	t _{GHQZ}	—	3.8	—	4	—	6	ns	4, 5
Clock High to Q High-Z	t _{KHQZ}	1.5	7.5	1.5	10	1.5	15	ns	4, 5
Setup Times: Address ADSP, ADSC, ADV Data In Write Chip Enable	t _{ADKH} t _{ADSKH} t _{DVKH} t _{WVKH} t _{EVKH}	2	—	2	—	2	—	ns	
Hold Times: Address ADSP, ADSC, ADV Data In Write Chip Enable	t _{KHAX} t _{KHADSX} t _{KHDX} t _{KHWX} t _{KHEX}	0.5	—	0.5	—	0.5	—	ns	

NOTES:

- Write is defined as either any \overline{SBx} and \overline{SW} low or \overline{SGW} is low. Chip Enable is defined as $\overline{SE1}$ low, SE2 high, and $\overline{SE3}$ low whenever \overline{ADSP} or \overline{ADSC} is asserted.
- All read and write cycle timings are referenced from K or \overline{G} .
- In order to reduce test correlation issues and to reduce the effects of application specific input edge rate variations on correlation between data sheet parameters and actual system performance, FSRAM AC parametric specifications are always specified at V_{DDQ}/2. In some design exercises, it is desirable to evaluate timing using other reference levels. Since the maximum test input edge rate is known and is given in the AC Test Conditions section of the data sheet as 1 V/ns, one can easily interpolate timing values to other reference levels.
- This parameter is sampled and not 100% tested.
- Measured at ± 200 mV from steady state.

Freescale Semiconductor, Inc.

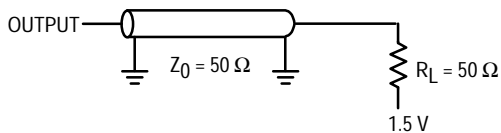

Figure 2. AC Test Load

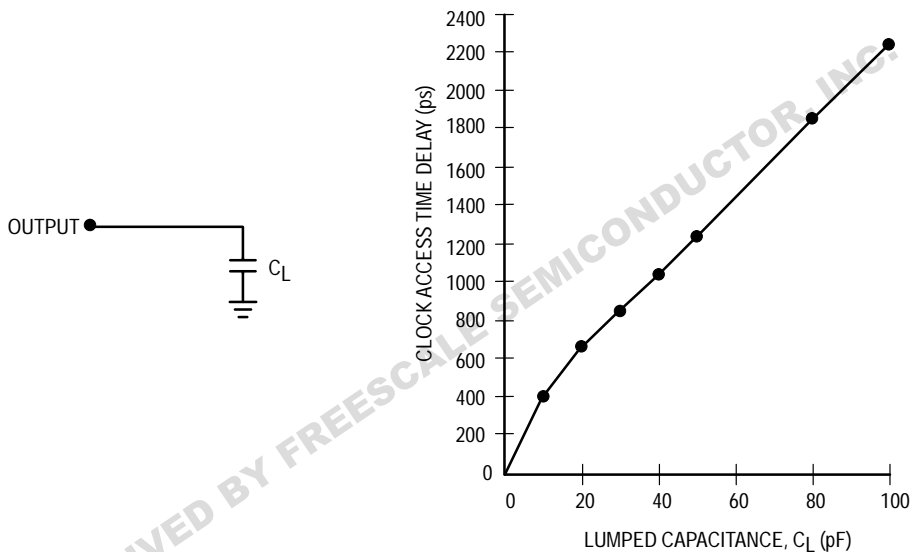
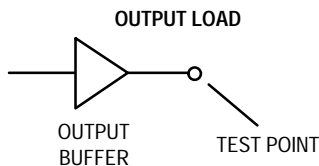
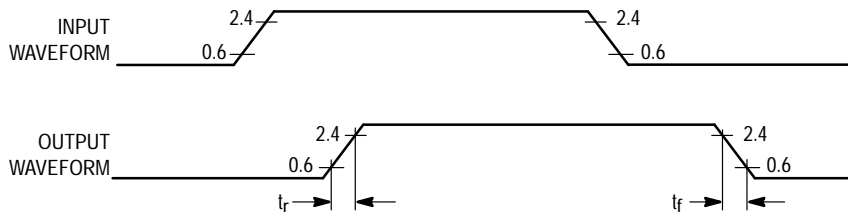

Figure 3. Lumped Capacitive Load and Typical Derating Curve



UNLOADED RISE AND FALL TIME MEASUREMENT



NOTES:

1. Input waveform has a slew rate of 1 V/ns.
2. Rise time is measured from 0.6 to 2.4 V unloaded.
3. Fall time is measured from 2.4 to 0.6 V unloaded.

Figure 4. Unloaded Rise and Fall Time Characterization

PULL-UP		
VOLTAGE (V)	I (mA) MIN	I (mA) MAX
-0.5	-38	-105
0	-38	-105
0.8	-38	-105
1.25	-26	-83
1.5	-20	-70
2.3	0	-30
2.7	0	-10
2.9	0	0

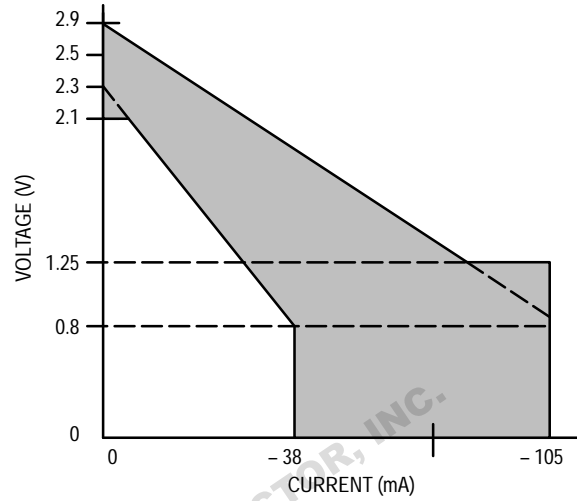

(a) Pull-Up for 2.5 V I/O Supply

PULL-UP		
VOLTAGE (V)	I (mA) MIN	I (mA) MAX
-0.5	-50	-150
0	-50	-150
1.4	-50	-150
1.65	-46	-130
2.0	-35	-101
3.135	0	-25
3.6	0	0

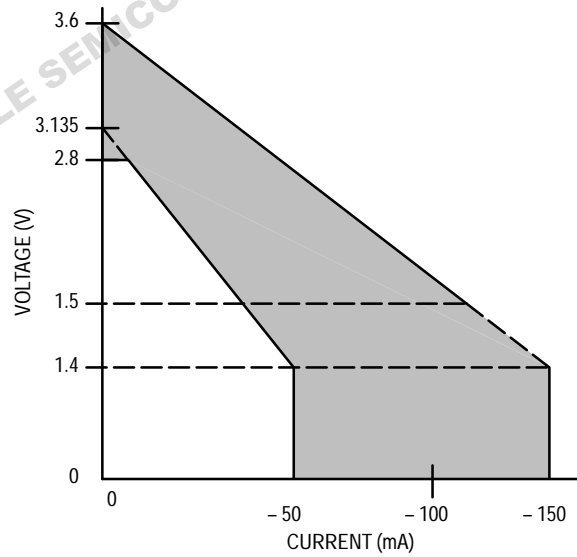

(b) Pull-Up for 3.3 V I/O Supply

PULL-DOWN		
VOLTAGE (V)	I (mA) MIN	I (mA) MAX
-0.5	0	0
0	0	0
0.4	10	20
0.8	20	40
1.25	31	63
1.6	40	80
2.8	40	80
3.2	40	80
3.4	40	80

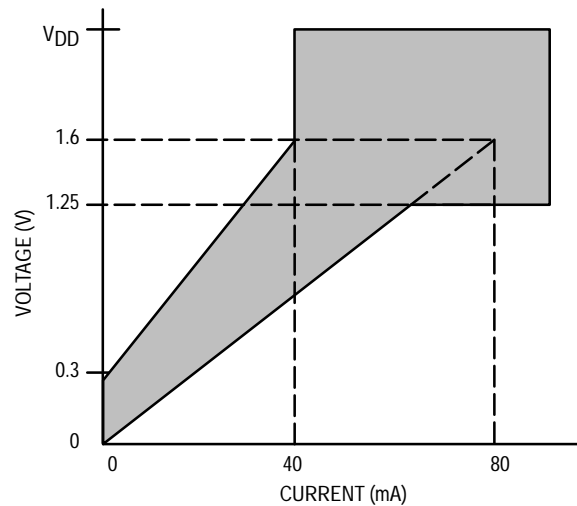

(c) Pull-Down

Figure 5. Typical Output Buffer Characteristics

READ/WRITE CYCLES

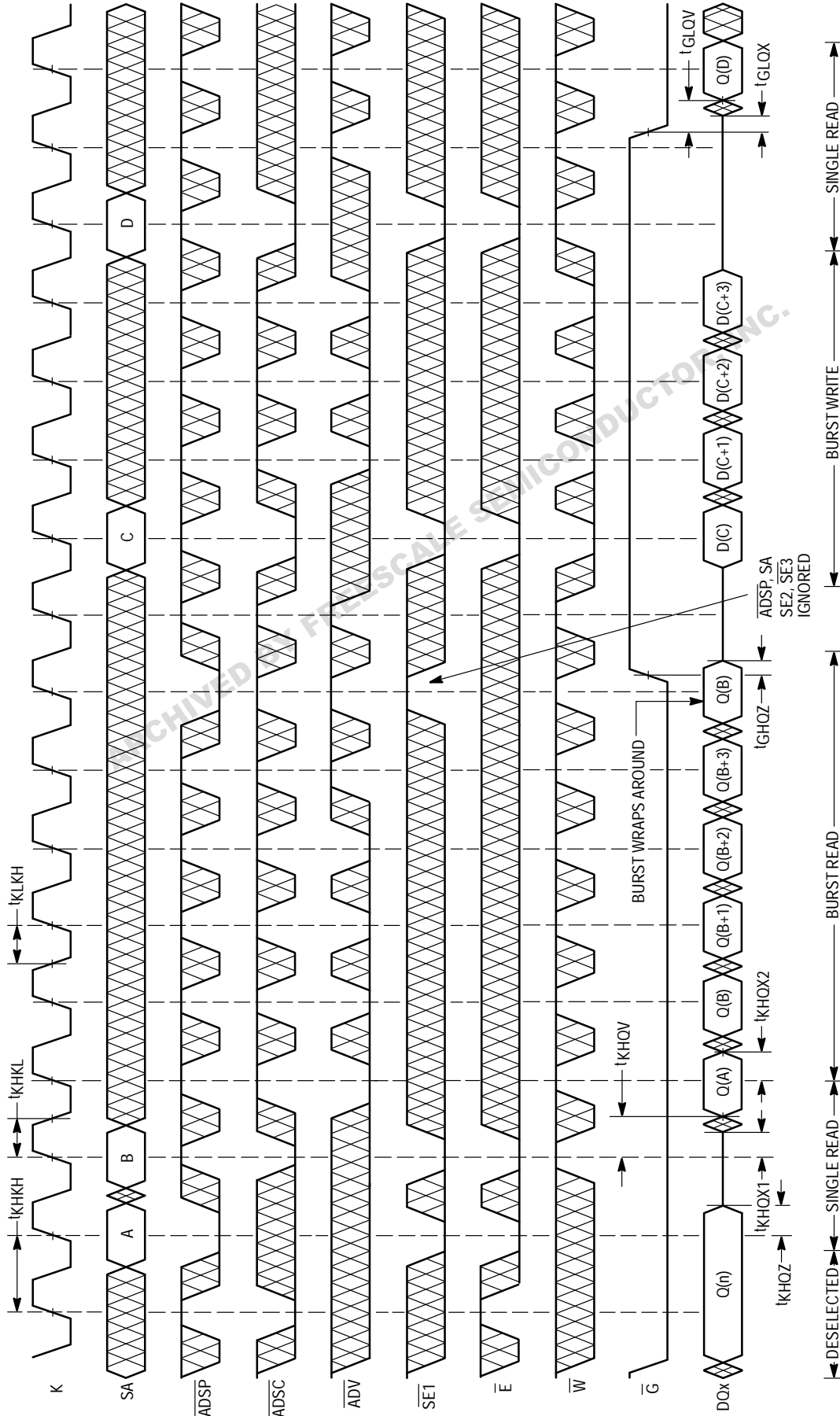

NOTE: \bar{E} low = $\overline{SE2}$ high and $\overline{SE3}$ low.
 \bar{W} low = \overline{SGW} low and/or \overline{SW} and \overline{SBx} low.

SLEEP MODE TIMING

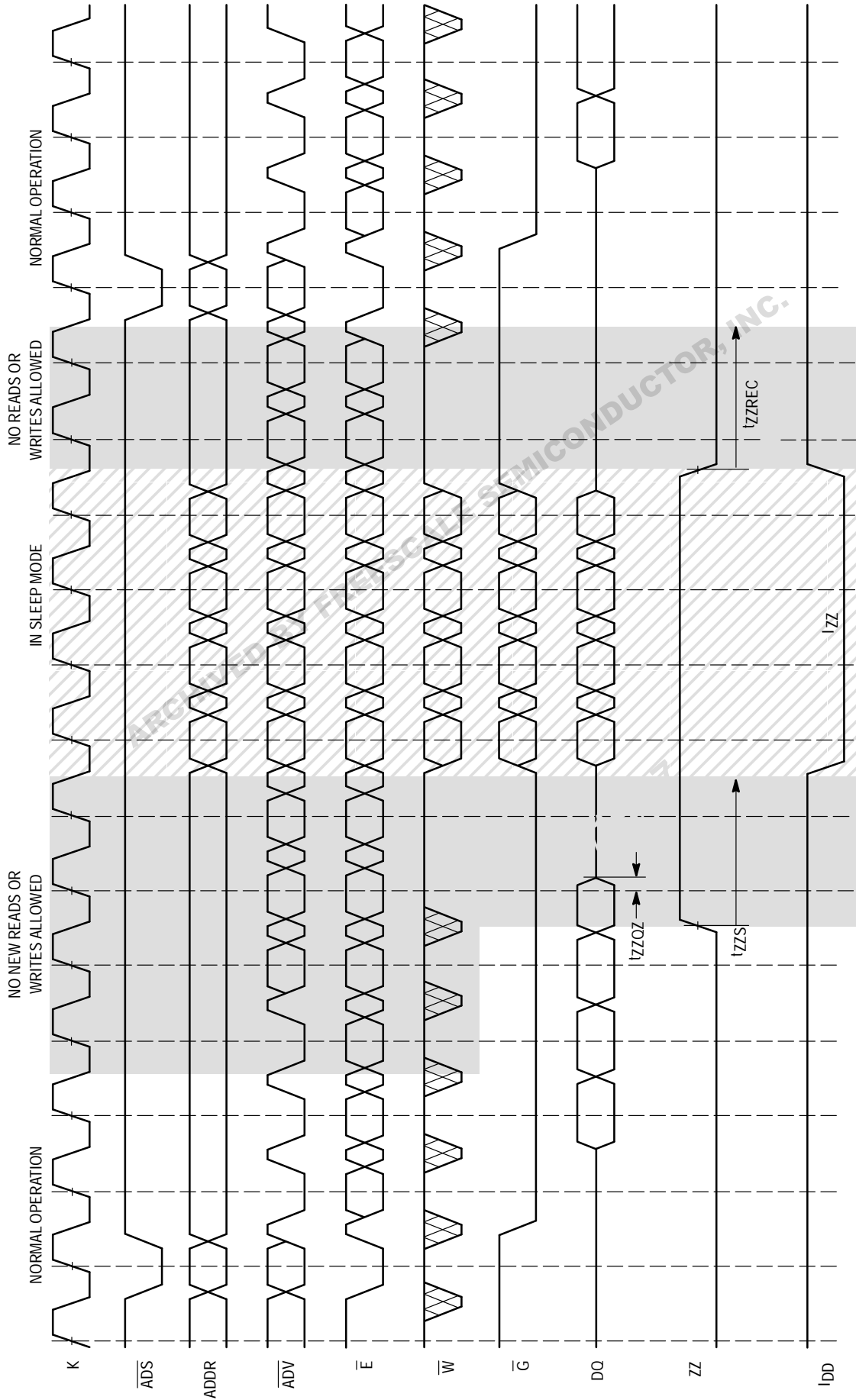

NOTE: \overline{ADS} low = \overline{ADSC} low or \overline{ADSP} low.
 \overline{ADS} high = both \overline{ADSC} , \overline{ADSP} high.
 \overline{E} low = $\overline{SE1}$ low, $\overline{SE2}$ high, $\overline{SE3}$ low.
 IZZ (max) specifications will not be met if inputs toggle.

APPLICATION INFORMATION

SLEEP MODE

A sleep mode feature, the ZZ pin, has been implemented on the MCM63P736 and MCM63P818. It allows the system designer to place the RAM in the lowest possible power condition by asserting ZZ. The sleep mode timing diagram shows the different modes of operation: Normal Operation, No READ/WRITE Allowed, and Sleep Mode. Each mode has its own set of constraints and conditions that are allowed.

Normal Operation: All inputs must meet setup and hold times prior to sleep and t_{ZZREC} nanoseconds after recovering from sleep. Clock (K) must also meet cycle, high, and low times during these periods. Two cycles prior to sleep, initiation of either a read or write operation is not allowed.

No READ/WRITE: During the period of time just prior to sleep and during recovery from sleep, the assertion of either ADSC, ADSP, or any write signal is not allowed. If a write operation occurs during these periods, the memory array may be corrupted. Validity of data out from the RAM can not be guaranteed immediately after ZZ is asserted (prior to being in sleep).

Sleep Mode: The RAM automatically deselects itself. The RAM disconnects its internal clock buffer. The external clock may continue to run without impacting the RAM's sleep

current (I_{ZZ}). All inputs are allowed to toggle — the RAM will not be selected and perform any reads or writes. However, if inputs toggle, the I_{ZZ} (max) specification will not be met.

Note: It is invalid to go from stop clock mode directly into sleep mode.

NON-BURST SYNCHRONOUS OPERATION

Although this BurstRAM has been designed for PowerPC—and other high end MPU-based systems, these SRAMs can be used in other high speed L2 cache or memory applications that do not require the burst address feature. Most L2 caches designed with a synchronous interface can make use of the MCM63P736 and MCM63P818. The burst counter feature of the BurstRAMs can be disabled, and the SRAMs can be configured to act upon a continuous stream of addresses. See Figure 6.

CONTROL PIN TIE VALUES EXAMPLE ($H \geq V_{IH}$, $L \leq V_{IL}$)

Non-Burst	ADSP	ADSC	ADV	SE1	SE2	LBO
Sync Non-Burst, Pipelined SRAM	H	L	H	L	H	X

NOTE: Although X is specified in the table as a don't care, the pin must be tied either high or low.

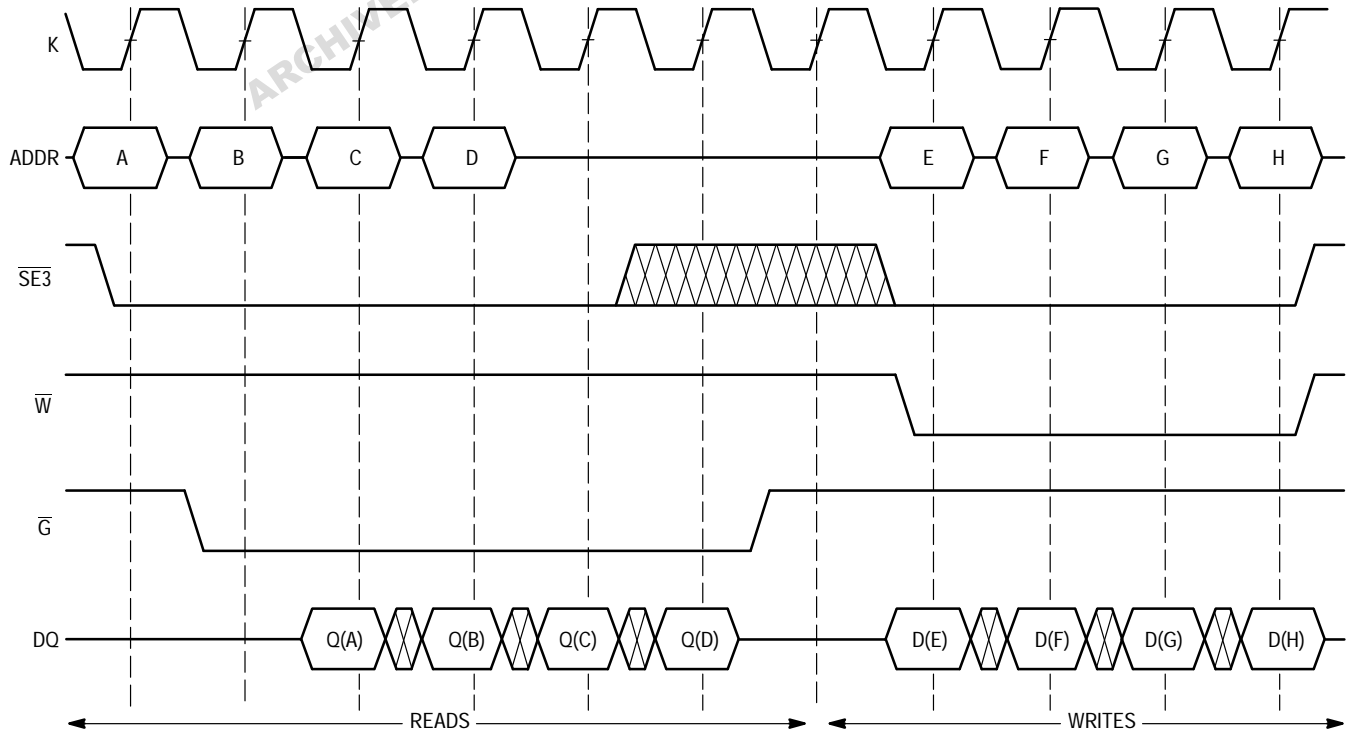
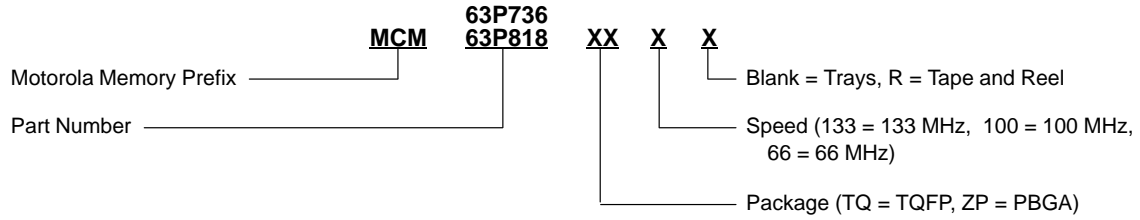

Figure 6. Example Configuration as Non-Burst Synchronous SRAM

Freescale Semiconductor, Inc.

ORDERING INFORMATION (Order by Full Part Number)



Full Part Numbers —	MCM63P736TQ133	MCM63P736TQ100	MCM63P736TQ66
	MCM63P736TQ133R	MCM63P736TQ100R	MCM63P736TQ66R
	MCM63P736ZP133	MCM63P736ZP100	MCM63P736ZP66
	MCM63P736ZP133R	MCM63P736ZP100R	MCM63P736ZP66R
	MCM63P818TQ133	MCM63P818TQ100	MCM63P818TQ66
	MCM63P818TQ133R	MCM63P818TQ100R	MCM63P818TQ66R
	MCM63P818ZP133	MCM63P818ZP100	MCM63P818ZP66
	MCM63P818ZP133R	MCM63P818ZP100R	MCM63P818ZP66R

ARCHIVED BY FREESCALE SEMICONDUCTOR, INC.

Freescale Semiconductor, Inc.

PACKAGE DIMENSIONS

TQ PACKAGE
TQFP
CASE 983A-01

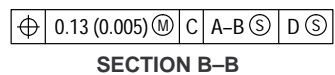
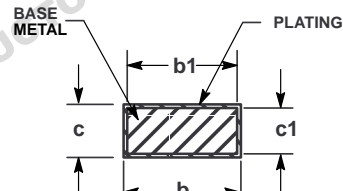
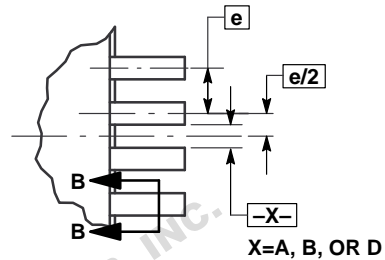
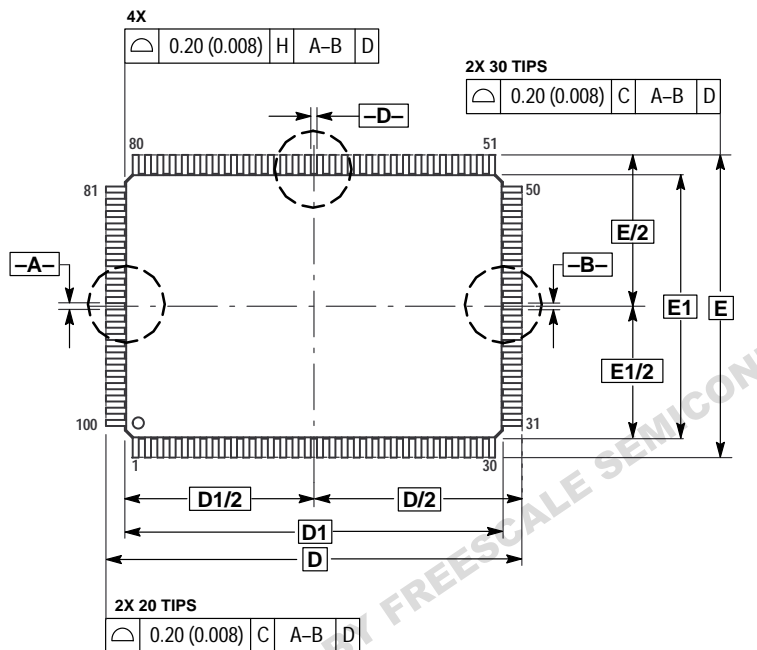

SECTION B-B

- NOTES:
1. DIMENSIONING AND TOLERANCING PER ANSI Y14.5M, 1982.
 2. CONTROLLING DIMENSION: MILLIMETER.
 3. DATUM PLANE -H- IS LOCATED AT BOTTOM OF LEAD AND IS COINCIDENT WITH THE LEAD WHERE THE LEAD EXITS THE PLASTIC BODY AT THE BOTTOM OF THE PARTING LINE.
 4. DATUMS -A-, -B- AND -D- TO BE DETERMINED AT DATUM PLANE -H-.
 5. DIMENSIONS D AND E TO BE DETERMINED AT SEATING PLANE -C-.
 6. DIMENSIONS D1 AND E1 DO NOT INCLUDE MOLD PROTRUSION. ALLOWABLE PROTRUSION IS 0.25 (0.010) PER SIDE. DIMENSIONS D1 AND B1 DO INCLUDE MOLD MISMATCH AND ARE DETERMINED AT DATUM PLANE -H-.
 7. DIMENSION b DOES NOT INCLUDE DAMBAR PROTRUSION. DAMBAR PROTRUSION SHALL NOT CAUSE THE b DIMENSION TO EXCEED 0.45 (0.018).

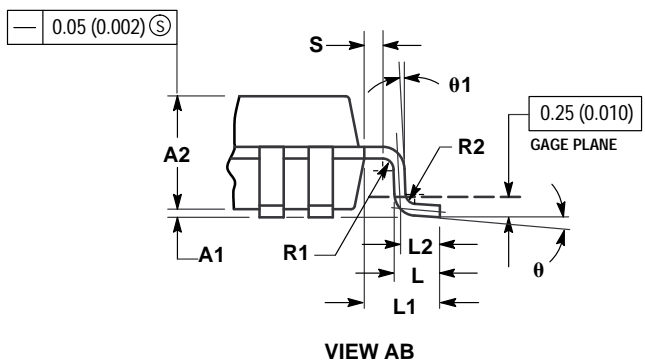
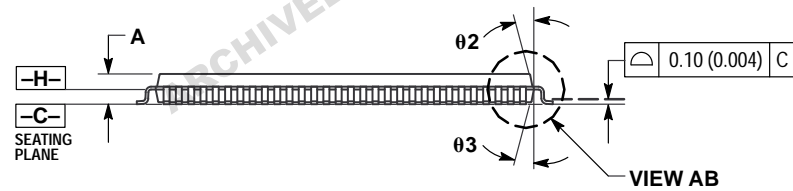

DIM	MILLIMETERS		INCHES	
	MIN	MAX	MIN	MAX
A	---	1.60	---	0.063
A1	0.05	0.15	0.002	0.006
A2	1.35	1.45	0.053	0.057
b	0.22	0.38	0.009	0.015
b1	0.22	0.33	0.009	0.013
c	0.09	0.20	0.004	0.008
c1	0.09	0.16	0.004	0.006
D	22.00 BSC		0.866 BSC	
D1	20.00 BSC		0.787 BSC	
E	16.00 BSC		0.630 BSC	
E1	14.00 BSC		0.551 BSC	
e	0.65 BSC		0.026 BSC	
L	0.45	0.75	0.018	0.030
L1	1.00 REF		0.039 REF	
L2	0.50 REF		0.020 REF	
S	0.20	---	0.008	---
R1	0.08	---	0.003	---
R2	0.08	0.20	0.003	0.008
theta	0°	7°	0°	7°
theta 1	0°	---	0°	---
theta 2	11°	13°	11°	13°
theta 3	11°	13°	11°	13°

Freescale Semiconductor, Inc.

Freescale Semiconductor, Inc.

ZP PACKAGE 7 x 17 BUMP PBGA CASE 999-02

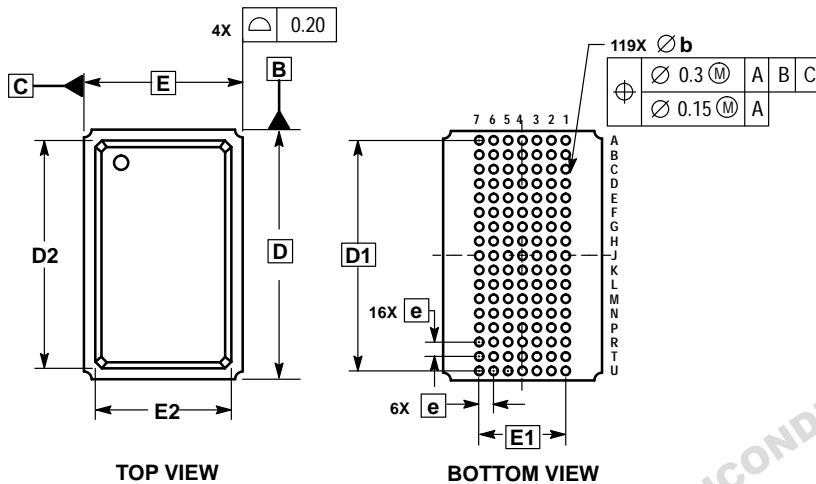

NOTES:

1. DIMENSIONING AND TOLERANCING PER ASME Y14.5M, 1994.
2. ALL DIMENSIONS IN MILLIMETERS.
3. DIMENSION b IS THE MAXIMUM SOLDER BALL DIAMETER MEASURED PARALLEL TO DATUM A.
4. DATUM A, THE SEATING PLANE, IS DEFINED BY THE SPHERICAL CROWNS OF THE SOLDER BALLS.

DIM	MILLIMETERS	
	MIN	MAX
A	---	2.40
A1	0.50	0.70
A2	1.30	1.70
A3	0.80	1.00
D	22.00 BSC	
D1	20.32 BSC	
D2	19.40	19.60
E	14.00 BSC	
E1	7.62 BSC	
E2	11.90	12.10
b	0.60	0.90
e	1.27 BSC	

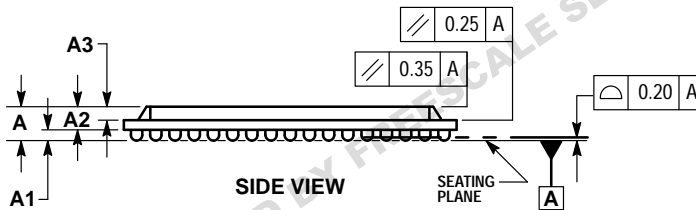

Motorola reserves the right to make changes without further notice to any products herein. Motorola makes no warranty, representation or guarantee regarding the suitability of its products for any particular purpose, nor does Motorola assume any liability arising out of the application or use of any product or circuit, and specifically disclaims any and all liability, including without limitation consequential or incidental damages. "Typical" parameters which may be provided in Motorola data sheets and/or specifications can and do vary in different applications and actual performance may vary over time. All operating parameters, including "Typicals" must be validated for each customer application by customer's technical experts. Motorola does not convey any license under its patent rights nor the rights of others. Motorola products are not designed, intended, or authorized for use as components in systems intended for surgical implant into the body, or other applications intended to support or sustain life, or for any other application in which the failure of the Motorola product could create a situation where personal injury or death may occur. Should Buyer purchase or use Motorola products for any such unintended or unauthorized application, Buyer shall indemnify and hold Motorola and its officers, employees, subsidiaries, affiliates, and distributors harmless against all claims, costs, damages, and expenses, and reasonable attorney fees arising out of, directly or indirectly, any claim of personal injury or death associated with such unintended or unauthorized use, even if such claim alleges that Motorola was negligent regarding the design or manufacture of the part. Motorola and are registered trademarks of Motorola, Inc. Motorola, Inc. is an Equal Opportunity/Affirmative Action Employer.

Mfax is a trademark of Motorola, Inc.

How to reach us:

USA/EUROPE/Locations Not Listed: Motorola Literature Distribution;
P.O. Box 5405, Denver, Colorado, 80217. 1-303-675-2140 or 1-800-441-2447

Mfax™: RMFAX0@email.sps.mot.com – TOUCHTONE 1-602-244-6609
Motorola Fax Back System – US & Canada ONLY 1-800-774-1848
– http://sps.motorola.com/mfax/

HOME PAGE: <http://motorola.com/sps/>

JAPAN: Motorola Japan Ltd.; SPD, Strategic Planning Office, 141,
4-32-1 Nishi-Gotanda, Shinagawa-ku, Tokyo, Japan. 81-3-5487-8488

ASIA/PACIFIC: Motorola Semiconductors H.K. Ltd.; Silicon Harbour Centre,
2 Dai King Street, Tai Po Industrial Estate, Tao Po, N.T., Hong Kong.
852-26629298

CUSTOMER FOCUS CENTER: 1-800-521-6274



For More Information On This Product,
Go to: www.freescale.com

MCM63P736/D