

TA58LT00F

150 mA Output Current and Tracking Regulator with ON/OFF Control Switch

The TA58LT00F consists of small-surface mount type tracking regulators with an output current of 150 mA (maximum) and an ON/OFF control switch. Control by an EN (ON/OFF) terminal enables the regulator to be operated only when required (output ON). The output voltage can be controlled to an arbitrary voltage between 2.5V and 13.4V by applying a necessary voltage to ADJ through a microcontroller, etc. It is also possible to enable or disable the regulator via the enable (ON/OFF) terminal. Enabling the regulator only when necessary contributes to the energy saving of equipment.

Features

- Built-in ON/OFF control function (active high)
- Maximum output current : 150mA
- Output voltage : 2.5 V ~ 13.4 V
- Tracking voltage accuracy : $\pm 10\text{mV}$ (@ $T_j = 25^\circ\text{C}$)
- Low standby current (output OFF mode) : 1 μA (Typ.)
- Protection function : Over-current protection / thermal shutdown / Reverse connection of power supply / 60 V load dump
- Package type : Surface-mount New PW-Mold5pin

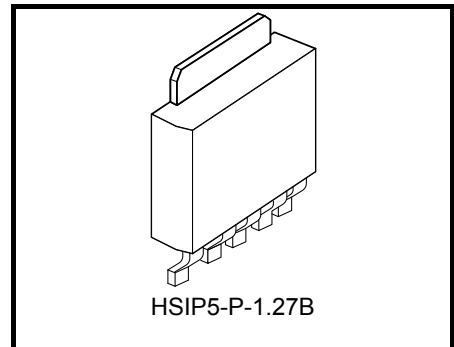

Weight : 0.36 g (Typ.)

Pin Assignment

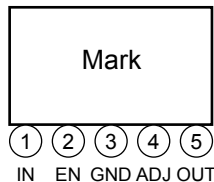

Marking

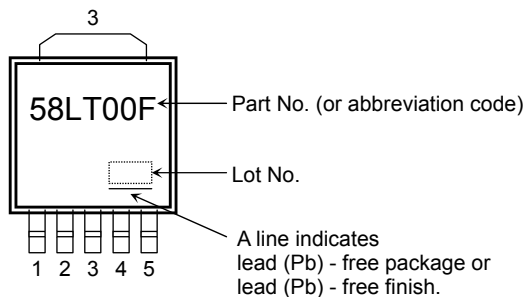

Pin Description

Pin No.	Symbol	Description
1	IN	Input terminal. Connected by capacitor (C_{IN}) to GND.
2	EN	Output ON/OFF control terminal. Output is ON when this pin is set to "High", OFF when this pin is open or set to "Low".
3	GND	Ground terminal
4	ADJ	Adjustment terminal
5	OUT	Output terminal. Connected by capacitor (C_{OUT}) to GND.

How to Order

Product No.	Package	Package Type and Capacity
TA58LT00F(T6L1,Q)	New PW-Mold5pin : Surface-mount	Tape (2000 pcs/reel)

Block Diagram

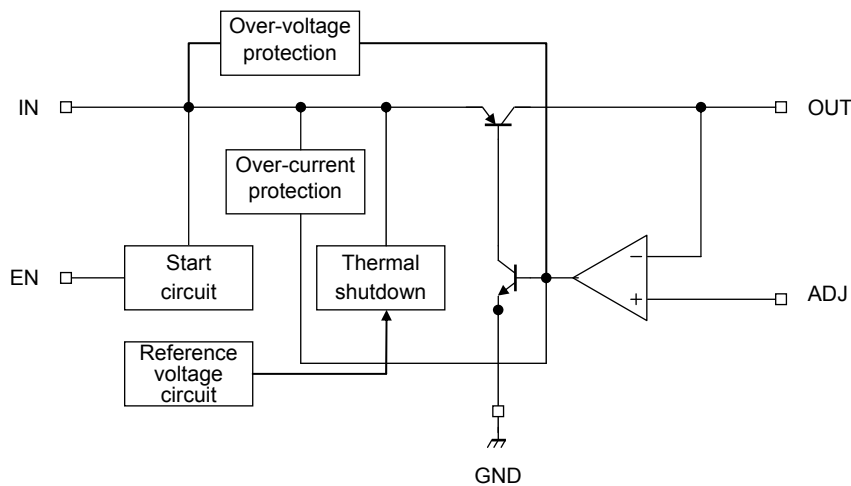

Absolute Maximum Rating (Ta = 25°C)

Characteristic	Symbol	Rating	Unit
Input voltage	V _{IN}	-38~38	V
EN Input voltage	V _{EN}	-0.3~38	V
ADJ Input voltage	V _{ADJ}	-0.3~38	V
Output current	I _{OUT}	150	mA
Junction temperature	T _j	150	°C
Storage temperature	T _{stg}	-55~150	°C
Power dissipation	Ta = 25°C	P _D	W
	Tc = 25°C		
			10

Note 1: Do not apply current and voltage (including reverse polarity) to any pin that is not specified.

Note 2: If it is connected EN terminal to IN terminal, be careful so that the negative voltage is not impressed on EN terminal.

Note 3: Using continuously under heavy loads (e.g. the application of high temperature/current/voltage and the significant change in temperature, etc.) may cause this product to decrease in the reliability significantly even if the operating conditions (i.e. operating temperature/current/voltage, etc.) are within the absolute maximum ratings and the operating ranges.

Please design the appropriate reliability upon reviewing the Toshiba Semiconductor Reliability Handbook ("Handling Precautions"/Derating Concept and Methods) and individual reliability data (i.e. reliability test report and estimated failure rate, etc).

Thermal Characteristics

Characteristic	Symbol	Max	Unit
Thermal resistance, junction to ambient	R _{th(j-a)}	125	°C/W
Thermal resistance, junction to case	R _{th(j-c)}	12.5	°C/W

Recommended operating conditions

Characteristic	Symbol	Min	Typ.	Max	Unit
Input voltage	V _{IN}	6	—	26	V
ADJ Input voltage	V _{ADJ}	2.5	—	13.4	V
Operating junction temperature	T _{j(opr)}	-40	—	135	°C

Protection Function (Reference)

Characteristic	Symbol	Test Condition	Min	Typ.	Max	Unit
Thermal shutdown	T _{SD}	V _{IN} = 14 V	150	175	—	°C
Thermal shutdown hysteresis width	T _{SD(hys)}		—	15	—	°C
Peak circuit current	I _{PEAK}	V _{IN} = 14 V, T _j = 25°C	—	210	—	mA
Short circuit current	I _{SC}	V _{IN} = 14 V, T _j = 25°C	—	210	—	mA
Overvoltage protection	V _{OV}	—	38	—	—	V

Note 4: Ensure th at the devices operate within the limits of the maximum rating when in actual use.

Note 5: When the input vo Itage exceeds 38 V, the overvoltage protection circuit is activated to turn off the output voltage.

Electrical Characteristics

(Unless otherwise specified, $2.5\text{ V} \leq V_{\text{ADJ}} \leq 13.4\text{ V}$, $V_{\text{EN}} = \text{H}$, $C_{\text{IN}} = 0.33\ \mu\text{F}$, $C_{\text{OUT}} = 10\ \mu\text{F}$, $\text{ESR} = 1\ \Omega$, $T_j = -40\sim 125^\circ\text{C}$)

Characteristic	Symbol	Test Condition	Min	Typ.	Max	Unit
Tracking accuracy	ΔV_{OUT}	$V_{\text{IN}} = 14\text{ V}$, $I_{\text{OUT}} = 50\text{ mA}$	-10	—	+10	mV
		$6\text{ V} \leq V_{\text{IN}} \leq 26\text{ V}$, $5\text{ mA} \leq I_{\text{OUT}} \leq 100\text{ mA}$, $-40^\circ\text{C} \leq T_j \leq 125^\circ\text{C}$	-20	—	+20	
Line regulation	Reg·line	$6\text{ V} \leq V_{\text{IN}} \leq 26\text{ V}$, $I_{\text{OUT}} = 50\text{ mA}$	—	—	25	mV
Load regulation	Reg·load	$V_{\text{IN}} = 14\text{ V}$, $5\text{ mA} \leq I_{\text{OUT}} \leq 100\text{ mA}$	—	—	35	mV
Quiescent current	I_{B}	$6\text{ V} \leq V_{\text{IN}} \leq 26\text{ V}$, $I_{\text{OUT}} = 0\text{ A}$	—	—	0.8	mA
		$6\text{ V} \leq V_{\text{IN}} \leq 26\text{ V}$, $I_{\text{OUT}} = 100\text{ mA}$	—	—	15	
Quiescent current (OFF mode)	$I_{\text{B(OFF)}}$	$6\text{ V} \leq V_{\text{IN}} \leq 26\text{ V}$, $V_{\text{EN}} = 0\text{ V}$	—	—	20	μA
Dropout voltage	V_{D}	$I_{\text{OUT}} = 50\text{ mA}$	—	—	0.3	V
		$I_{\text{OUT}} = 100\text{ mA}$	—	—	0.6	
Output control voltage (ON)	$V_{\text{EN(ON)}}$	$I_{\text{OUT}} = 50\text{ mA}$	3	—	—	V
Output control voltage (OFF)	$V_{\text{EN(OFF)}}$	—	—	—	0.5	V
Output control current (ON)	$I_{\text{EN(ON)}}$	$V_{\text{IN}} = 14\text{ V}$, $V_{\text{EN}} = 5\text{ V}$, $I_{\text{OUT}} = 1\text{ mA}$	—	—	120	μA

Electrical Characteristics Common to All Products

- $T_j = 25^\circ\text{C}$ in the measurement conditions of each item is a regulation for where the standard condition when a pulse test is carried out, and any drift in the electrical characteristic due to a rise in the junction temperature of the chip may be disregarded.

Standard Application Circuit

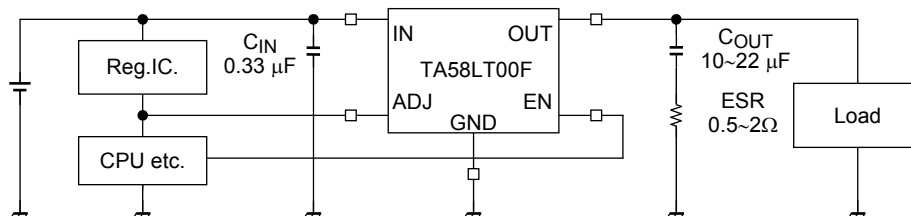

- Place C_{IN} as close as possible to the input terminal and GND. Place C_{OUT} as close as possible to the output terminal and GND. Although capacitor C_{OUT} acts to smooth the dc output voltage during suspension of output oscillation or load change, it might cause output oscillation in a cold environment due to increased capacitor ESR. It is therefore recommended to use a capacitor with small temperature sensitivity. Please connect the resistance of $0.5\sim 2\Omega$ with the series when the ceramic capacitor is used.

The IC may oscillate due to external conditions (output current, temperature, or the type of the capacitor used). The type of capacitor required must be determined by the actual application circuit in which the IC is used.

The notice in case of application

- Note that, depending on the load conditions, a steep increase in the input voltage (V_{IN}) may cause a momentary rise in output voltage (V_{OUT}) even if the EN (enable) pin is Low.

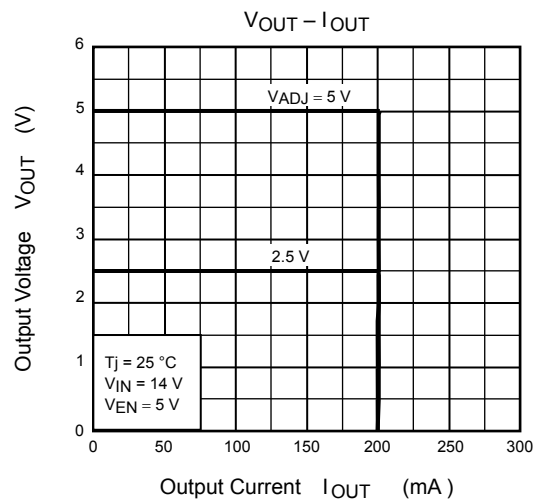
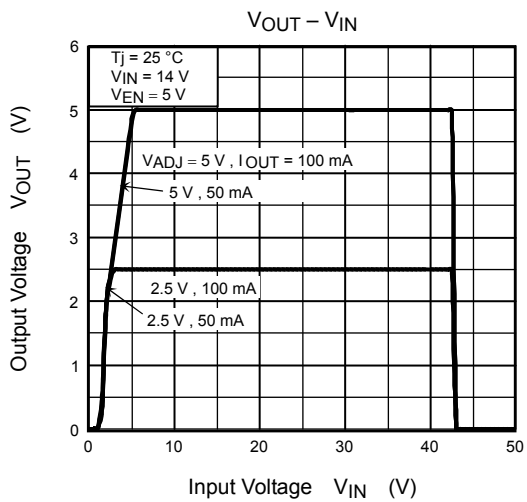
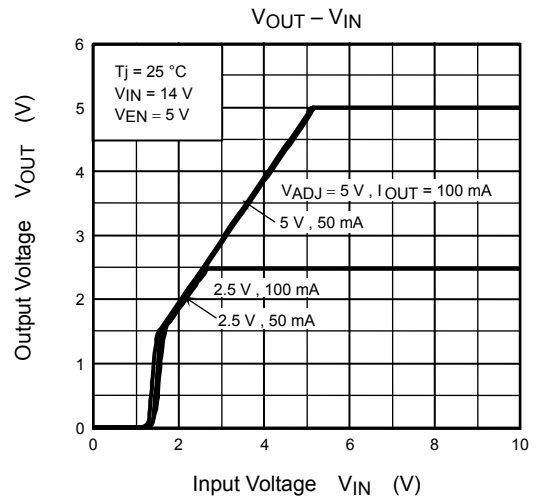
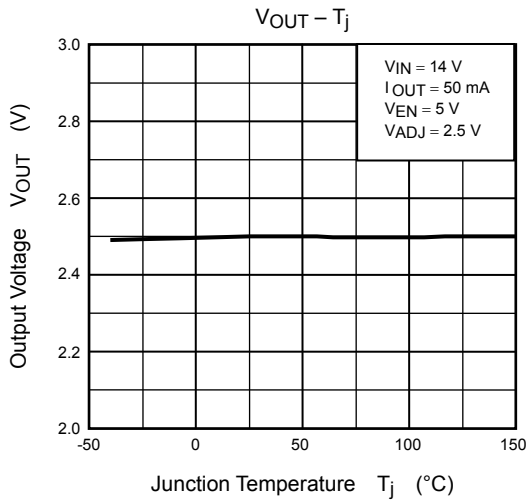
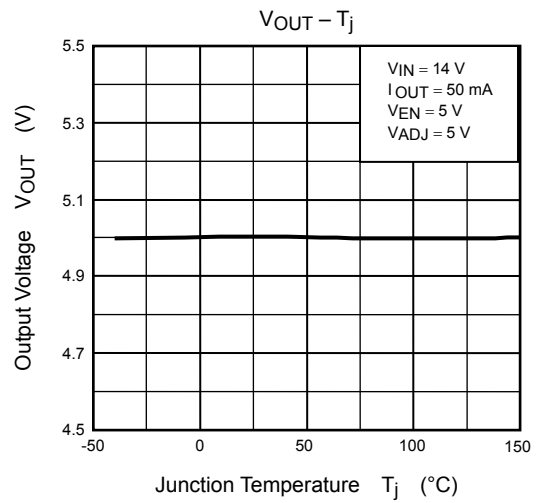
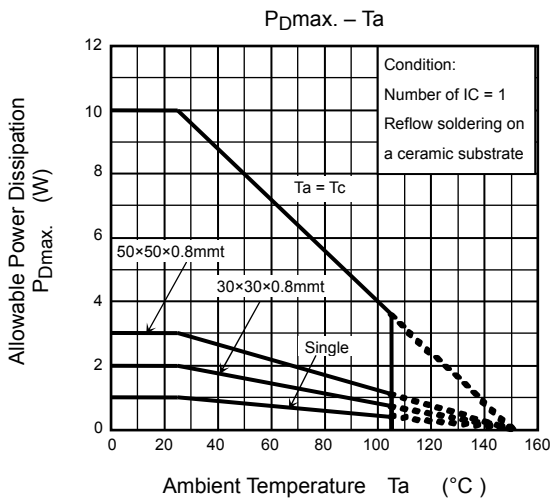

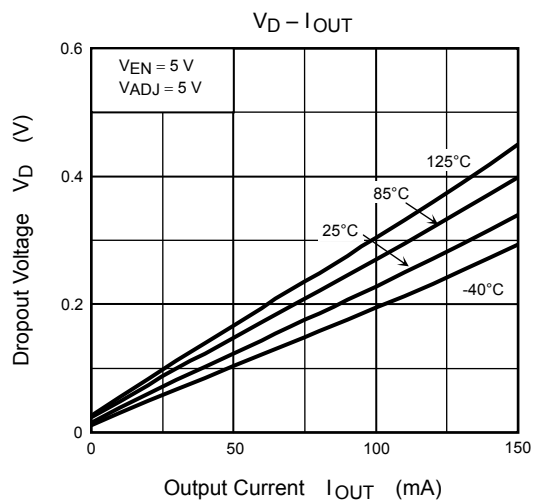
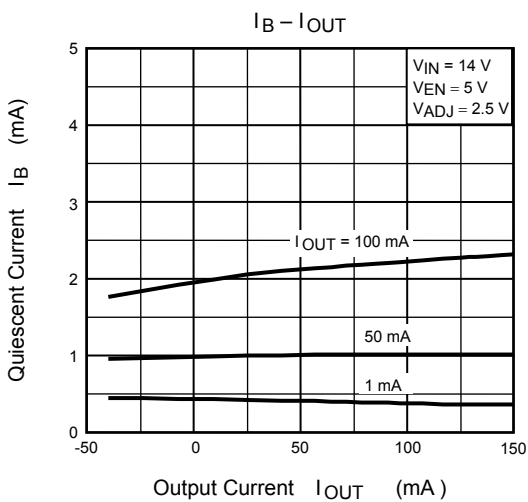
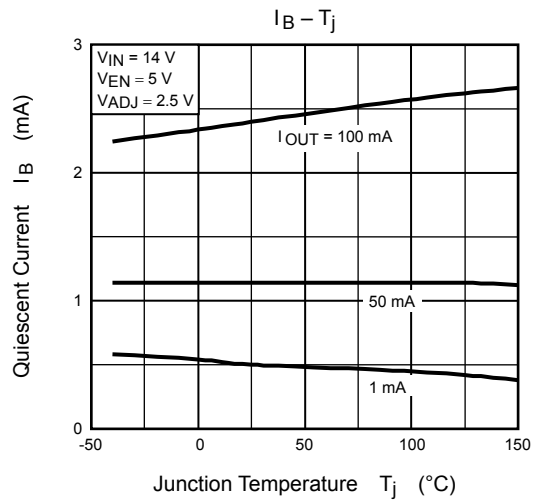
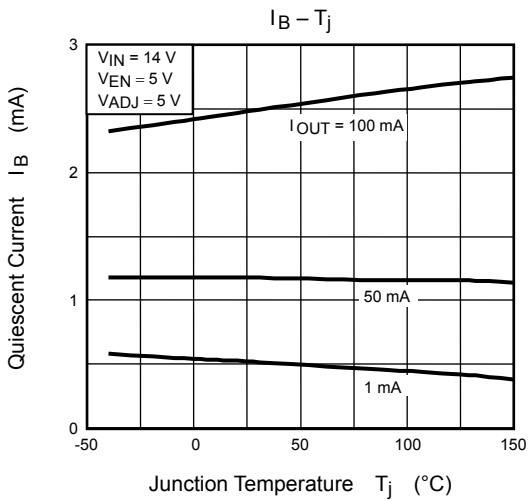
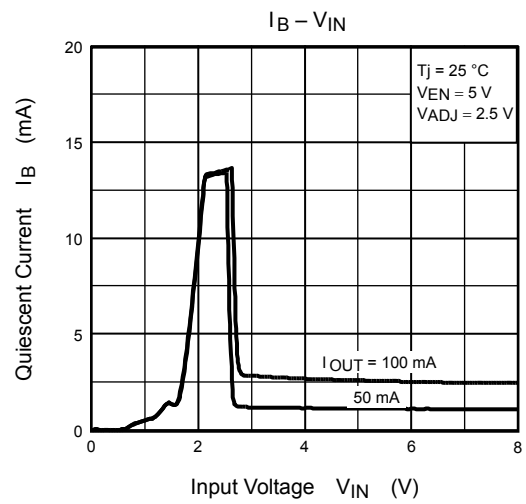
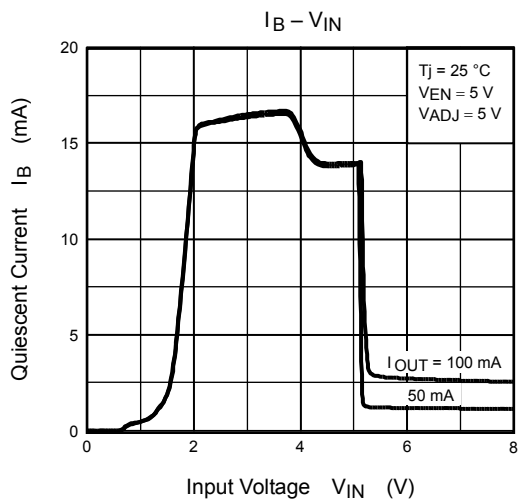

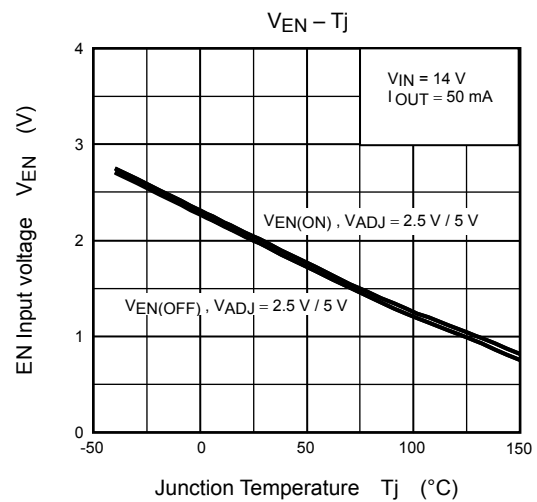
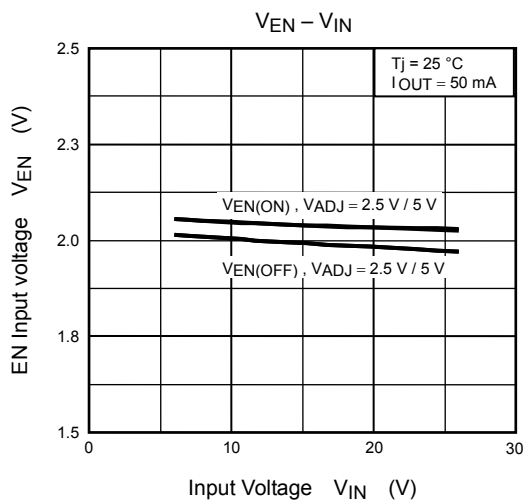
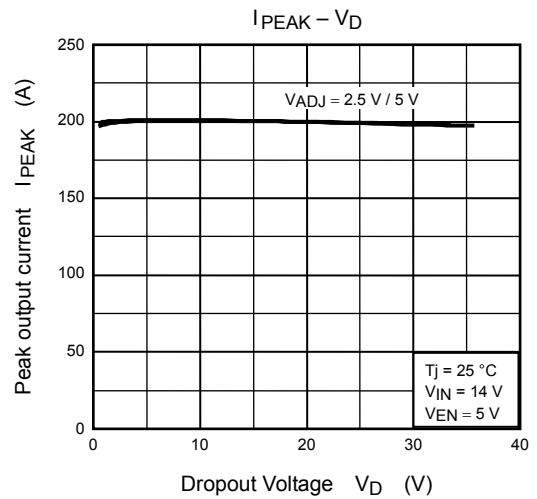
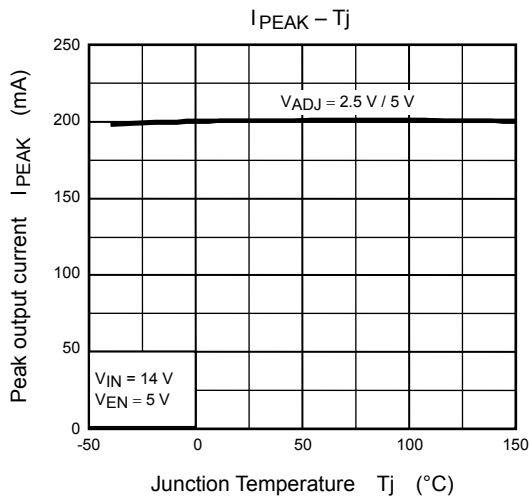
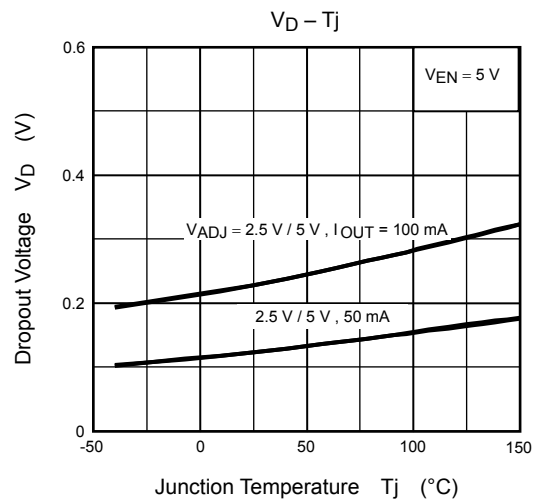
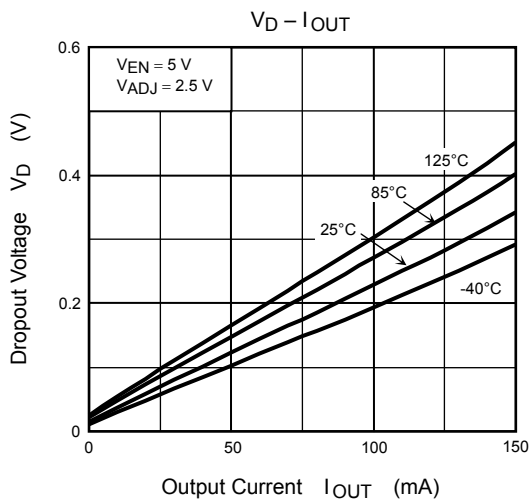

Package Dimensions

HSIP5-P-1.27B

Unit : mm

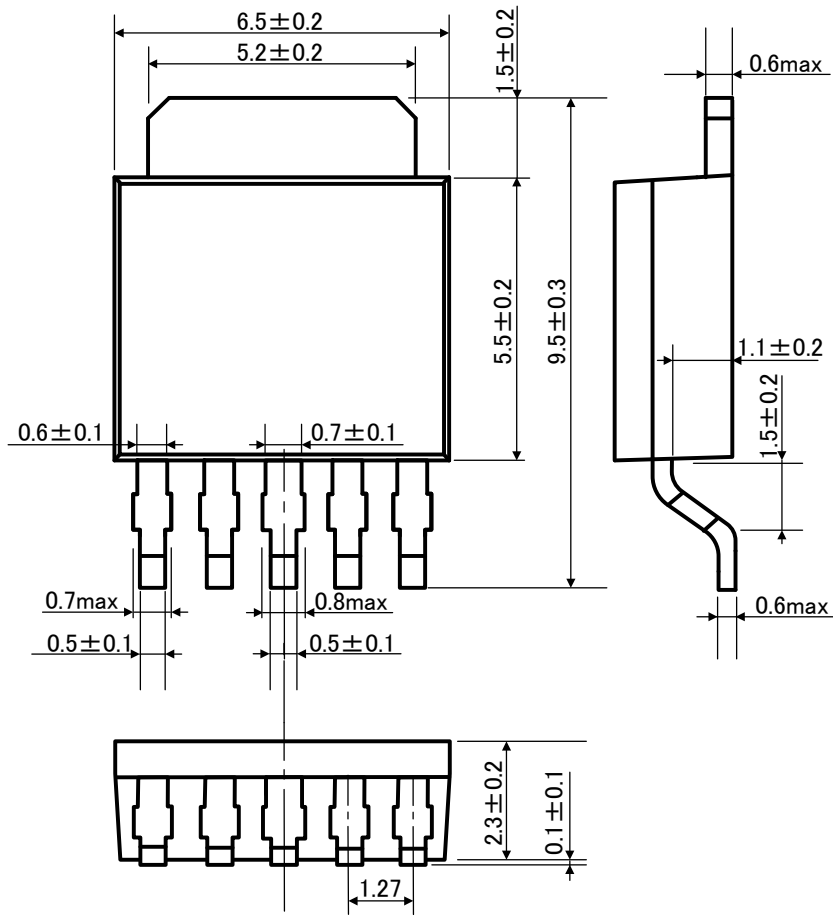

Weight: 0.36 g (Typ.)

RESTRICTIONS ON PRODUCT USE

20070701-EN

- The information contained herein is subject to change without notice.
- TOSHIBA is continually working to improve the quality and reliability of its products. Nevertheless, semiconductor devices in general can malfunction or fail due to their inherent electrical sensitivity and vulnerability to physical stress. It is the responsibility of the buyer, when utilizing TOSHIBA products, to comply with the standards of safety in making a safe design for the entire system, and to avoid situations in which a malfunction or failure of such TOSHIBA products could cause loss of human life, bodily injury or damage to property.
In developing your designs, please ensure that TOSHIBA products are used within specified operating ranges as set forth in the most recent TOSHIBA products specifications. Also, please keep in mind the precautions and conditions set forth in the "Handling Guide for Semiconductor Devices," or "TOSHIBA Semiconductor Reliability Handbook" etc.
- The TOSHIBA products listed in this document are intended for usage in general electronics applications (computer, personal equipment, office equipment, measuring equipment, industrial robotics, domestic appliances, etc.). These TOSHIBA products are neither intended nor warranted for usage in equipment that requires extraordinarily high quality and/or reliability or a malfunction or failure of which may cause loss of human life or bodily injury ("Unintended Usage"). Unintended Usage include atomic energy control instruments, airplane or spaceship instruments, transportation instruments, traffic signal instruments, combustion control instruments, medical instruments, all types of safety devices, etc.. Unintended Usage of TOSHIBA products listed in this document shall be made at the customer's own risk.
- The products described in this document shall not be used or embedded to any downstream products of which manufacture, use and/or sale are prohibited under any applicable laws and regulations.
- The information contained herein is presented only as a guide for the applications of our products. No responsibility is assumed by TOSHIBA for any infringements of patents or other rights of the third parties which may result from its use. No license is granted by implication or otherwise under any patents or other rights of TOSHIBA or the third parties.
- Please contact your sales representative for product-by-product details in this document regarding RoHS compatibility. Please use these products in this document in compliance with all applicable laws and regulations that regulate the inclusion or use of controlled substances. Toshiba assumes no liability for damage or losses occurring as a result of noncompliance with applicable laws and regulations.