

EVALUATION KIT MANUAL
FOLLOWS DATA SHEET

MAXIM

3.3V/5V/Adjustable-Output, Step-Up DC-DC Converters

MAX756/MAX757

General Description

The MAX756/MAX757 are CMOS step-up DC-DC switching regulators for small, low input voltage or battery-powered systems. The MAX756 accepts a positive input voltage down to 0.7V and converts it to a higher pin-selectable output voltage of 3.3V or 5V. The MAX757 is an adjustable version that accepts an input voltage down to 0.7V and generates a higher adjustable output voltage in the range from 2.7V to 5.5V. Typical full-load efficiencies for the MAX756/MAX757 are greater than 87%.

The MAX756/MAX757 provide three improvements over previous devices. Physical size is reduced—the high switching frequencies (up to 0.5MHz) made possible by MOSFET power transistors allow for tiny (<5mm diameter) surface-mount magnetics. Efficiency is improved to 87% (10% better than with low-voltage regulators fabricated in bipolar technology). Supply current is reduced to 60μA by CMOS construction and a unique constant-off-time pulse-frequency modulation control scheme.

Applications

- 3.3V to 5V Step-Up Conversion
- Palmtop Computers
- Portable Data-Collection Equipment
- Personal Data Communicators/Computers
- Medical Instrumentation
- 2-Cell & 3-Cell Battery-Operated Equipment
- Glucose Meters

Typical Operating Circuit

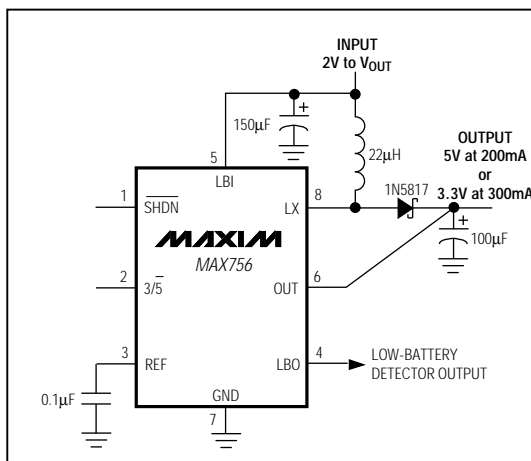

Features

- ◆ Operates Down to 0.7V Input Supply Voltage
- ◆ 87% Efficiency at 200mA
- ◆ 60μA Quiescent Current
- ◆ 20μA Shutdown Mode with Active Reference and LBI Detector
- ◆ 500kHz Maximum Switching Frequency
- ◆ ±1.5% Reference Tolerance Over Temperature
- ◆ Low-Battery Detector (LBI/LBO)
- ◆ 8-Pin DIP and SO Packages

Ordering Information

PART	TEMP. RANGE	PIN-PACKAGE
MAX756CPA	0°C to +70°C	8 Plastic DIP
MAX756CSA	0°C to +70°C	8 SO
MAX756C/D	0°C to +70°C	Dice*
MAX756EPA	-40°C to +85°C	8 Plastic DIP
MAX756ESA	-40°C to +85°C	8 SO
MAX757CPA	0°C to +70°C	8 Plastic DIP
MAX757CSA	0°C to +70°C	8 SO
MAX757C/D	0°C to +70°C	Dice*
MAX757EPA	-40°C to +85°C	8 Plastic DIP
MAX757ESA	-40°C to +85°C	8 SO

* Dice are tested at $T_A = +25^\circ\text{C}$ only.

Pin Configurations

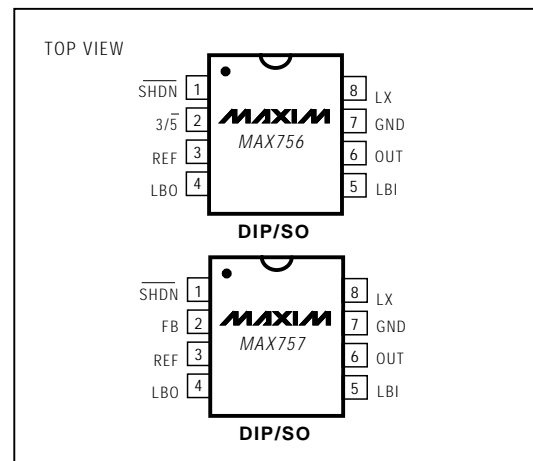

MAXIM

Maxim Integrated Products 1

Call toll free 1-800-998-8800 for free samples or literature.

3.3V/5V/Adjustable-Output, Step-Up DC-DC Converters

ABSOLUTE MAXIMUM RATINGS

Supply Voltage (OUT to GND)	-0.3V, +7V
Switch Voltage (LX to GND)	-0.3V, +7V
Auxiliary Pin Voltages (SHDN, LBI, LBO, REF, 3/5, FB to GND)	-0.3V, (V _{OUT} + 0.3V)
Reference Current (I _{REF})	2.5mA
Continuous Power Dissipation (T _A = +70°C)	
Plastic DIP (derate 9.09mW/°C above +70°C)	727mW
SO (derate 5.88mW/°C above +70°C)	471mW

Operating Temperature Ranges:

MAX75_C_ _	0°C to +70°C
MAX75_E_ _	-40°C to +85°C
Junction Temperature	+150°C
Storage Temperature Range	-65°C to +160°C
Lead Temperature (soldering, 10sec)	+300°C

Stresses beyond those listed under "Absolute Maximum Ratings" may cause permanent damage to the device. These are stress ratings only, and functional operation of the device at these or any other conditions beyond those indicated in the operational sections of the specifications is not implied. Exposure to absolute maximum rating conditions for extended periods may affect device reliability.

ELECTRICAL CHARACTERISTICS

(Circuits of Figure 1 and Typical Operating Circuit, V_{IN} = 2.5V, I_{LOAD} = 0mA, T_A = T_{MIN} to T_{MAX}, unless otherwise noted.)

PARAMETER	CONDITIONS	MIN	TYP	MAX	UNITS	
Output Voltage	2V < V _{IN} < 3V	MAX756, 3/5 = 0V, 0mA < I _{LOAD} < 200mA	4.8	5.0	5.2	V
		MAX756, 3/5 = 3V, 0mA < I _{LOAD} < 300mA	3.17	3.30	3.43	
		MAX757, V _{OUT} = 5V, 0mA < I _{LOAD} < 200mA	4.8	5.0	5.2	
Minimum Start-Up Supply Voltage	I _{LOAD} = 10mA		1.1	1.8	V	
Minimum Operating Supply Voltage (once started)	I _{LOAD} = 20mA		0.7		V	
Quiescent Supply Current in 3.3V Mode (Note 1)	I _{LOAD} = 0mA, 3/5 = 3V, LBI = 1.25V, V _{OUT} = 3.47V, FB = 1.3V (MAX757 only)			60	μA	
Battery Quiescent Current Measured at V _{IN} in Figure 1	Output set for 3.3V		60		μA	
Shutdown Quiescent Current (Note 1)	SHDN = 0V, LBI = 1.25V, 3/5 = 3V, V _{OUT} = 3.47V, FB = 1.3V (MAX757 only)		20	40	μA	
Reference Voltage	No REF load, C _{REF} = 0.1μF	1.23	1.25	1.27	V	
Reference-Voltage Regulation	3/5 = 3V, -20μA < REF load < 250μA, C _{REF} = 0.22μF		0.8	2.0	%	
LBI Input Threshold	With falling edge	1.22	1.25	1.28	V	
LBI Input Hysteresis			25		mV	
LBO Output Voltage Low	I _{SINK} = 2mA			0.4	V	
LBO Output Leakage Current	LBO = 5V			1	μA	
SHDN, 3/5 Input Voltage Low				0.4	V	
SHDN, 3/5 Input Voltage High		1.6			V	
SHDN, 3/5, FB, LBI Input Current	LBI = 1.25V, FB = 1.25V, SHDN = 0V or 3V, 3/5 = 0V or 3V			±100	nA	
FB Voltage	MAX757	1.22	1.25	1.28	V	
Output Voltage Range	MAX757, I _{LOAD} = 0mA (Note 2)	2.7		5.5	V	

Note 1: Supply current from the 3.3V output is measured with an ammeter between the 3.3V output and OUT pin. This current correlates directly with actual battery supply current, but is reduced in value according to the step-up ratio and efficiency.

Note 2: Minimum value is production tested. Maximum value is guaranteed by design and is not production tested.

3.3V/5V/Adjustable-Output, Step-Up DC-DC Converters

Typical Operating Characteristics

(Circuit of Figure 1, $T_A = +25^\circ\text{C}$, unless otherwise noted.)

MAX756/MAX757

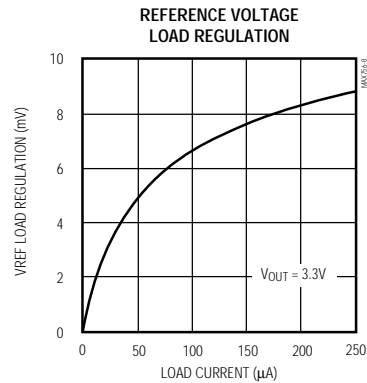
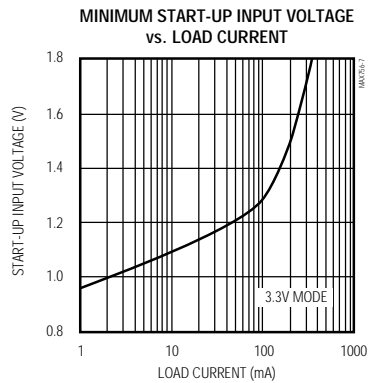
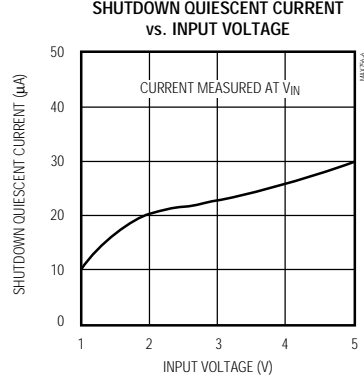
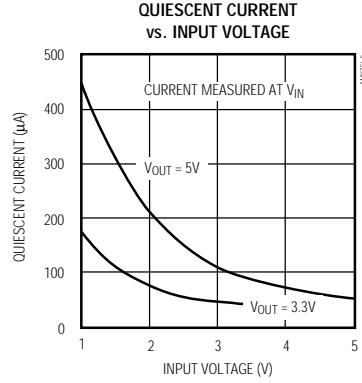
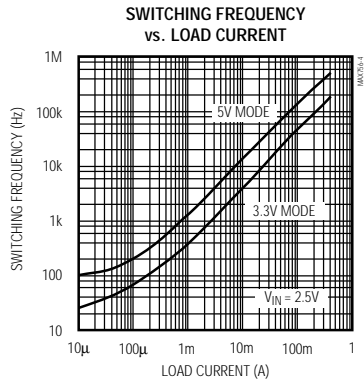
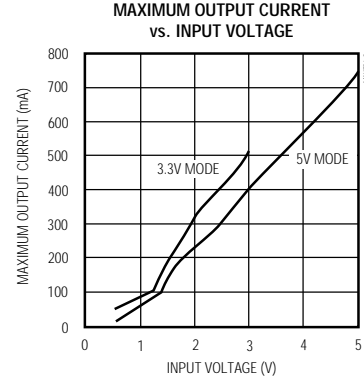
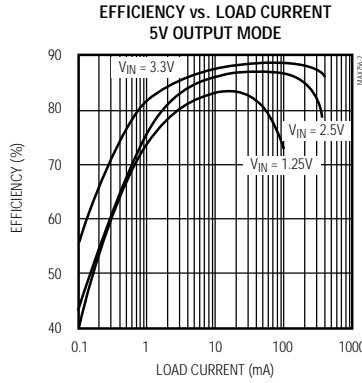
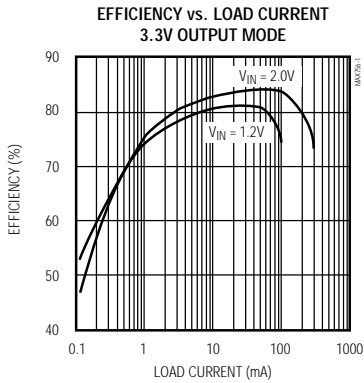

3.3V/5V/Adjustable-Output, Step-Up DC-DC Converters

Typical Operating Characteristics (continued)

(Circuit of Figure 1, $T_A = +25^\circ\text{C}$, unless otherwise noted.)

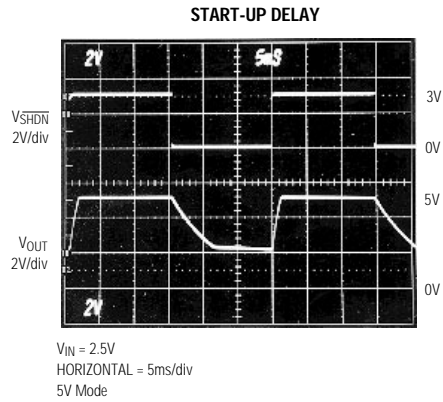
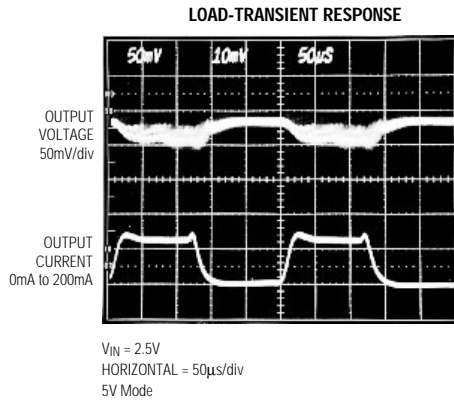

Pin Description

PIN		NAME	FUNCTION
MAX756	MAX757		
1	1	$\overline{\text{SHDN}}$	Shutdown Input disables SMPS when low, but the voltage reference and low-battery comparator remain active.
2	-	3/5	Selects the main output voltage setting; 5V when low, 3.3V when high.
-	2	FB	Feedback Input for adjustable output operation. Connect to an external voltage divider between OUT and GND.
3	3	REF	1.25V Reference Voltage Output. Bypass with 0.22µF to GND (0.1µF if there is no external reference load). Maximum load capability is 250µA source, 20µA sink.
4	4	LBO	Low-Battery Output. An open-drain N-channel MOSFET sinks current when the voltage at LBI drops below +1.25V.
5	5	LBI	Low-Battery Input. When the voltage on LBI drops below +1.25V, LBO sinks current. Connect to V_{IN} if not used.
6	6	OUT	Connect OUT to the regulator output. It provides bootstrapped power to both devices, and also senses the output voltage for the MAX756.
7	7	GND	Power Ground. Must be low impedance; solder directly to ground plane.
8	8	LX	1A, 0.5Ω N-Channel Power MOSFET Drain

3.3V/5V/Adjustable-Output, Step-Up DC-DC Converters

MAX756/MAX757

Detailed Description

Operating Principle

The MAX756/MAX757 combine a switch-mode regulator with an N-channel MOSFET, precision voltage reference, and power-fail detector in a single monolithic device. The MOSFET is a "sense-FET" type for best efficiency, and has a very low gate threshold voltage to ensure start-up under low-battery voltage conditions (1.1V typ).

Pulse-Frequency Modulation Control Scheme

A unique minimum off time, current-limited, pulse-frequency modulation (PFM) control scheme is a key feature of the MAX756/MAX757. This PFM scheme combines the advantages of pulse-width modulation (PWM) (high output power and efficiency) with those of a traditional PFM pulse-skipper (ultra-low quiescent currents). There is no oscillator; at heavy loads, switching is accomplished through a constant peak-current limit in the switch, which allows the inductor current to self-oscillate between this peak limit and some lesser value. At light loads, switching frequency is governed by a pair of one-shots, which set a minimum off-time (1 μ s) and a maximum on-time (4 μ s). The switching frequency depends on the load and the input voltage, and can range as high as 500kHz.

The peak switch current of the internal MOSFET power switch is fixed at 1A \pm 0.2A. The switch's on resistance is typically 0.5 Ω , resulting in a switch voltage drop (V_{SW}) of about 500mV under high output loads. The value of V_{SW} decreases with light current loads.

Conventional PWM converters generate constant-frequency switching noise, whereas this architecture produces variable-frequency switching noise. However, the noise does not exceed the switch current limit times the filter-capacitor equivalent series resistance (ESR), unlike conventional pulse-skippers.

Voltage Reference

The precision voltage reference is suitable for driving external loads such as an analog-to-digital converter. It has guaranteed 250 μ A source-current and 20 μ A sink-current capability. The reference is kept alive even in shutdown mode. If the reference drives an external load, bypass it with 0.22 μ F to GND. If the reference is unloaded, bypass it with at least 0.1 μ F.

Control-Logic Inputs

The control inputs ($\overline{3}/\overline{5}$, \overline{SHDN}) are high-impedance MOS gates protected against ESD damage by normally reverse-biased clamp diodes. If these inputs are driven from signal sources that exceed the main supply

voltage, the diode current should be limited by a series resistor (1M Ω suggested). The logic input threshold level is the same (approximately 1V) in both 3.3V and 5V modes. Do not leave the control inputs floating.

Design Procedure

Output Voltage Selection

The MAX756 output voltage can be selected to 3.3V or 5V under logic control, or it can be left in one mode or the other by tying $\overline{3}/\overline{5}$ to GND or OUT. Efficiency varies depending upon the battery and the load, and is typically better than 80% over a 2mA to 200mA load range. The device is internally bootstrapped, with power derived from the output voltage (via OUT). When the output is set at 5V instead of 3.3V, the higher internal supply voltage results in lower switch-transistor on resistance and slightly greater output power. Bootstrapping allows the battery voltage to sag to less than 1V once the system is started. Therefore, the battery voltage range is from $V_{OUT} + V_D$ to less than 1V (where V_D is the forward drop of the Schottky rectifier). If the battery voltage exceeds the programmed output voltage, the output will follow the battery voltage. In many systems this is acceptable; however, the output voltage must not be forced above 7V.

The output voltage of the MAX757 is set by two resistors, R1 and R2 (Figure 1), which form a voltage divider between the output and the FB pin. The output voltage is set by the equation:

$$V_{OUT} = (V_{REF}) [(R2 + R1) / R2]$$

where $V_{REF} = 1.25V$.

To simplify resistor selection:

$$R1 = (R2) [(V_{OUT} / V_{REF}) - 1]$$

Since the input bias current at FB has a maximum value of 100nA, large values (10k Ω to 200k Ω) can be used for R1 and R2 with no significant loss of accuracy. For 1% error, the current through R1 should be at least 100 times FB's bias current.

Low-Battery Detection

The MAX756/MAX757 contain on-chip circuitry for low-battery detection. If the voltage at LBI falls below the regulator's internal reference voltage (1.25V), LBO (an open-drain output) sinks current to GND. The low-battery monitor's threshold is set by two resistors, R3 and R4 (Figure 1), which forms a voltage divider between the input voltage and the LBI pin. The threshold voltage is set by R3 and R4 using the following equation:

$$R3 = [(V_{IN} / V_{REF}) - 1] (R4)$$

3.3V/5V/Adjustable-Output, Step-Up DC-DC Converters

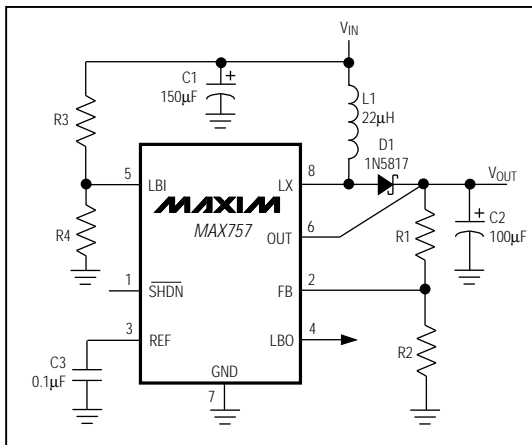

Figure 1. Standard Application Circuit

where V_{IN} is the desired threshold of the low-battery detector, R3 and R4 are the input divider resistors at LBI, and V_{REF} is the internal 1.25V reference.

Since the LBI current is less than 100nA, large resistor values (typically 10k Ω to 200k Ω) can be used for R3 and R4 to minimize loading of the input supply.

When the voltage at LBI is below the internal threshold, LBO sinks current to GND. A pull-up resistor of 10k Ω or more connected from LBO to V_{OUT} can be used when driving CMOS circuits. Any pull-up resistor connected to LBO should not be returned to a voltage source greater than V_{OUT} . When LBI is above the threshold, the LBO output is off. The low-battery comparator and reference voltage remain active when the MAX756/MAX757 is in shutdown mode.

If the low-battery comparator is not used, connect LBI to V_{IN} and leave LBO open.

Inductor Selection

The inductors should have a saturation (incremental) current rating equal to or greater than the peak switch-current limit, which is 1.2A worst-case. However, it's generally acceptable to bias the inductor into saturation by 20%, although this will reduce the efficiency.

The 22 μ H inductor shown in the typical applications circuit is sufficient for most MAX756/MAX757 application circuits. Higher input voltages increase the energy transferred with each cycle, due to the reduced input/output differential. Minimize excess ripple due to increased energy transfer by reducing the inductor value (10 μ H suggested).

The inductor's DC resistance significantly affects efficiency. For highest efficiency, limit L1's DC resistance to 0.03 Ω or less. See Table 1 for a list of suggested inductor suppliers.

Table 1. Component Suppliers

PRODUCTION METHOD	INDUCTORS	CAPACITORS
Surface-Mount	Sumida CD54-220 (22 μ H) CoilCraft DT3316-223 Coiltronics CTX20-1	AVX TPS series Sprague 595D series
Miniature Through-Hole	Sumida RCH654-220	Sanyo OS-CON OS-CON series low-ESR organic semiconductor
Low-Cost Through-Hole	CoilCraft PCH-27-223	Nichicon PL series low-ESR electrolytic United Chemi-Con LXF series

AVX	USA: (207) 282-5111, FAX (207) 283-1941 (800) 282-9975
CoilCraft	USA: (708) 639-6400, FAX (708) 639-1969
Coiltronics	USA: (407) 241-7876, FAX (407) 241-9339
Collmer Semiconductor	USA: (214) 233-1589
Motorola	USA: (602) 244-3576, FAX (602) 244-4015
Nichicon	USA: (708) 843-7500, FAX (708) 843-2798 Japan: +81-7-5231-8461, FAX (+81-) 7-5256-4158
Nihon	USA: (805) 867-2555, FAX (805) 867-2556 Japan: +81-3-3494-7411, FAX (+81-) 3-3494-7414
Sanyo OS-CON	USA: (619) 661-6835 Japan: +81-720-70-1005, FAX (+81-720-) 70-1174
Sprague	USA: (603) 224-1961, FAX (603) 224-1430
Sumida	USA: (708) 956-0666 Japan: +81-3-3607-5111, FAX (+81-3-) 3607-5428
United Chemi-Con	USA: (708) 696-2000, FAX (708) 640-6311

Capacitor Selection

A 100 μ F, 10V surface-mount (SMT) tantalum capacitor typically provides 50mV output ripple when stepping up from 2V to 5V at 200mA. Smaller capacitors, down to 10 μ F, are acceptable for light loads or in applications that can tolerate higher output ripple.

3.3V/5V/Adjustable-Output, Step-Up DC-DC Converters

PC Layout and Grounding

The MAX756/MAX757 high peak currents and high-frequency operation make PC layout important for minimizing ground bounce and noise. The distance between the MAX756/MAX757's GND pin and the ground leads of C1 and C2 in Figure 1 must be kept to less than 0.2" (5mm). All connections to the FB and LX pins should also be kept as short as possible. To obtain maximum output power and efficiency and minimum output ripple voltage, use a ground plane and solder the MAX756/MAX757 GND (pin 7) directly to the ground plane.

Chip Topography

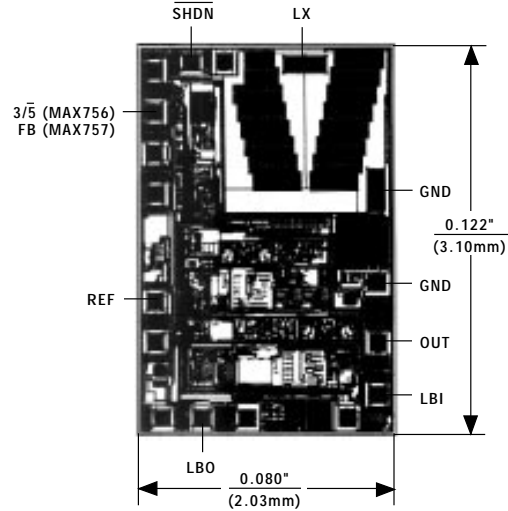

TRANSISTOR COUNT: 758
SUBSTRATE CONNECTED TO OUT

Package Information

DIM	INCHES		MILLIMETERS	
	MIN	MAX	MIN	MAX
A	0.053	0.069	1.35	1.75
A1	0.004	0.010	0.10	0.25
B	0.014	0.019	0.35	0.49
C	0.007	0.010	0.19	0.25
D	0.189	0.197	4.80	5.00
E	0.150	0.157	3.80	4.00
e	0.050 BSC		1.27 BSC	
H	0.228	0.244	5.80	6.20
h	0.010	0.020	0.25	0.50
L	0.016	0.050	0.40	1.27
α	0°	8°	0°	8°

21-325A

**8-PIN PLASTIC
SMALL-OUTLINE
PACKAGE**