

**SPECIFICATION**

SMD INDUCTORS (COMPACT TYPE)

BRL2515TYPE

-----  
-----  
-----  
-----

**TAIYO YUDEN**

	<b>Specifications</b>	
	BRL2515 TYPE	( 1 / 11 )

**1. Range of application**

This specification sheet applies to SMD inductor (compact type), BRL2515.

**2. Ordering code**

Example : BRL 2515 T 3R3 M D  
(1) (2) (3) (4) (5) (6)

- (1) Type
- (2) External dimensions
- (3) Packing style (T: Taping )
- (4) Inductance
- (5) Inductance tolerance (M=±20 %)
- (6) Special sign

**3. Standard measuring method**

Inductance : LCR meter ( HP 4285A or equivalent )  
Measuring signal level : 1V  
Test fixture ( HP 16034EA or equivalent )  
Measuring pressure : 170±20gf  
Self-resonance frequency : Impedance/Material Analyzer ( HP 4291A or equivalent)  
DC resistance : DC Ohmmeter ( HIOKI 3227 or equivalent)

**Standard test conditions**

Unless specified, Ambient temperature is 20±15 degC and the Relative humidity is 65±20 %.  
If there is any doubt about the test results, further measurement shall be had within the following limits:

Ambient Temperature: 20±2degC  
Relative humidity: 65±5%

Inductance value is based on our standard measurement systems.

**4. Operating temperature range**

-25 degC to +105 degC (Containing self temperature increase)

**5. Storage temperature range**

-40 degC to +85 degC (Product without taping)

**6. Electrical characteristics**

Refer to table 1.

**7. External dimensions and structural diagram**

Refer to Table 2.

**8. Mechanical characteristics**

Refer to Table 3.

**9. Environment test performance standards**

Refer to Table 3.

**10. Taping method**

Refer to Table 4.

**11. Packing form**

Refer to Table 5.

**12. Reflow profile chart**

Refer to Table 6.

	<b>Table 1</b>						
	<b>ELECTRICAL CHARACTERISTICS</b>						( 2 / 11 )

Ordering Code	Nominal Inductance [uH]	Inductance Tolerance [%]	D.C. Resistance ±30% [Ω]	Self Resonant Frequency min [MHz]	Rated*) Current max [mA]		Measuring Frequency [MHz]
					Saturation Current Idc1	Temperature Rise current Idc2	
BRL2515T1R0M	1.0	±20	0.070	160	1,500	1,350	1.0
BRL2515T1R5M	1.5	±20	0.100	130	1,200	1,150	1.0
BRL2515T2R2M	2.2	±20	0.135	100	1,000	1,000	1.0
BRL2515T3R3MD	3.3	±20	0.215	70	800	750	1.0
BRL2515T4R7MD	4.7	±20	0.265	60	650	700	1.0

\*) The saturation current value (Idc1) is the maximum DC current value having inductance decrease down to 30%. (at 20degC)

\*) The temperature rise current value (Idc2) is the maximum DC current value having temperature increase up to 40degC. (at 20degC)

\*) The rated current value is following either Idc1 or Idc2, which is the lower one.

	<b>Table 2</b>	
	EXTERNAL DIMENSIONS AND STRUCTURAL DIAGRAM	( 3 / 1 1 )

**1. External dimensions**

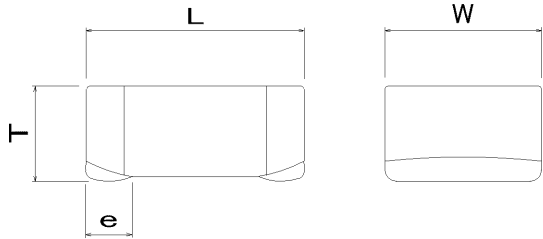

L	2.5±0.2
W	1.50±0.20
T	1.2 max
e	0.5±0.2

Unit: mm

**Appearance Criteria for Chip-off Mode  
( Top View )**

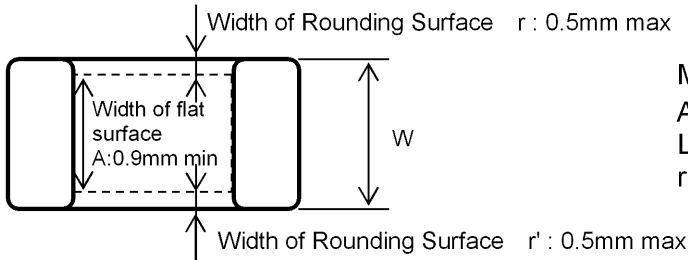

More than 0.9mm width of flat surface  
A shall be acceptable.  
Less than 0.5mm width of rounding surface  
r & r' shall be acceptable.

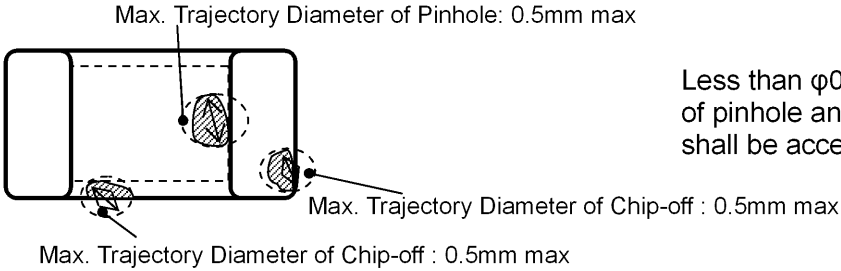

Less than φ0.5mm max. trajectory diameter  
of pinhole and / or chip-off of whole surface  
shall be acceptable.

**2. Structural diagram**

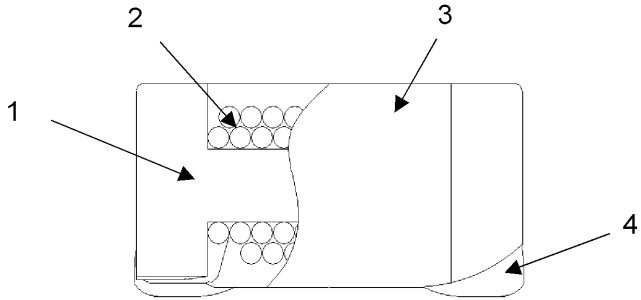

- |                       |  |
|-----------------------|--|
| 1. Ferrite core       | Ni– Zn ferrite                         |
| 2. Coil material      | Polyurethane-copper wire               |
| 3. Over-coating resin | Epoxy resin, containing ferrite powder |
| 4. Electrode          | Base material : Ag                     |
|                       | Foundation plating : Ni                |
|                       | Surface plating : Sn                   |

Table 3

STANDARDS

( 4 / 1 1 )

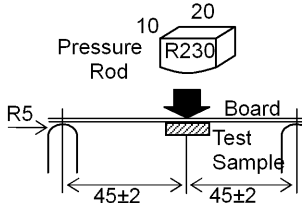
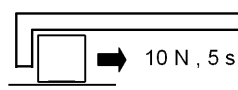
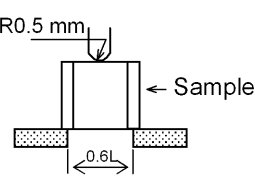
	Item	Standard	Test method
ELECTRICAL CHARACTERISTICS	Inductance	Refer to Table 1	LCR meter (HP4285A or equivalent) Measuring signal level : 1 V Test fixture (HP16034E or equivalent) Measuring pressure : $170 \pm 20$ gf
	Self resonant Frequency	Refer to Table 1	Impedance/material analyzer (HP4291A or equivalent)
	DC resistance	Refer to Table 1	DC ohm meter (HIOKI3227 or equivalent)
	Rated current	Refer to Table 1.	The maximum DC value having inductance decrease within 30 % and temperature increase within 40 degC by the application of DC bias.
	Over current Test	No smoke and no fire.	1.5 times the rated current was applied for 5 minutes.
MECHANICAL CHARACTERISTICS	Resistance to Flexure substrate	No damage.	<p>The test samples shall be soldered to the testing board and by reflow soldering conditions as show in table 6. Apply pressure in the direction of the arrow until bent width reaches 2 mm.</p>  <p style="text-align: right;">Unit : mm</p> <p>Substrate size : 100×40×1.0 Substrate material : glass epoxy-resin Solder cream thickness : 0.12 (Land size refer to recommended Land Pattern Dimensions of "Precaution")</p>
	Adhesion of Terminal electrode	No abnormality.	<p>The test samples shall be soldered to the testing board and by reflow soldering conditions as shown table 6.</p>  <p>Applied force : 10 N to X and Y directions. Duration : 5 s. Solder cream thickness : 0.12 mm (Land size refer to recommended Land Pattern Dimensions of "Precaution")</p>
	Body strength	No damage.	<p>Applied force : 10 N Duration : 10 s</p> 

	<b>Table 3</b>	
	STANDARDS	( 5 / 1 1 )

	Item	Standard	Test method														
ENVIRONMENT TESTS	Resistance to vibration	Inductance change: Within±10 % No abnormality observed in appearance.	The test samples shall be soldered to testing jig as shown in under table. <table border="1" style="margin-left: auto; margin-right: auto;"> <tr> <td>Frequency range</td> <td>10~55 Hz</td> </tr> <tr> <td>Overall Amplitude</td> <td>1.5 mm (Shall not exceed acceleration 196 m/S<sup>2</sup>)</td> </tr> <tr> <td>Sweeping Method</td> <td>10 to 55 to 10 Hz for 1 min.</td> </tr> <tr> <td>Time</td> <td>2 hours each in X, Y, and Z Direction.</td> </tr> </table>	Frequency range	10~55 Hz	Overall Amplitude	1.5 mm (Shall not exceed acceleration 196 m/S <sup>2</sup> )	Sweeping Method	10 to 55 to 10 Hz for 1 min.	Time	2 hours each in X, Y, and Z Direction.						
	Frequency range	10~55 Hz															
	Overall Amplitude	1.5 mm (Shall not exceed acceleration 196 m/S <sup>2</sup> )															
	Sweeping Method	10 to 55 to 10 Hz for 1 min.															
	Time	2 hours each in X, Y, and Z Direction.															
Resistance to soldering	Inductance change: Within±10 % No abnormality observed in appearance.	3 time of reflow oven at 230 degC min for 40 sec max, with peak temperature at 260+0/-5 degC for 5 sec max . Substrate thickness : 1.0 mm Substrate material : glass epoxy-resin															
Solderability	At least 90 % of terminal electrode is covered by new solder.	The test samples shall be submerged molten solder as shown in under table. Flux : methanol solution with 25 % of rosin or equivalent.  [Pb free solder : Sn-3Ag-0.5Cu] <table border="1" style="margin-left: auto; margin-right: auto;"> <tr> <td>Solder Temperature</td> <td>245±5 degC</td> </tr> <tr> <td>Time</td> <td>5±0.5 s</td> </tr> <tr> <td>Immersing Speed</td> <td>25 mm/s</td> </tr> </table> [Eutectic solder] <table border="1" style="margin-left: auto; margin-right: auto;"> <tr> <td>Solder Temperature</td> <td>230±5 degC</td> </tr> <tr> <td>Time</td> <td>5±0.5 s</td> </tr> <tr> <td>Immersing Speed</td> <td>25 mm/s</td> </tr> </table>	Solder Temperature	245±5 degC	Time	5±0.5 s	Immersing Speed	25 mm/s	Solder Temperature	230±5 degC	Time	5±0.5 s	Immersing Speed	25 mm/s			
Solder Temperature	245±5 degC																
Time	5±0.5 s																
Immersing Speed	25 mm/s																
Solder Temperature	230±5 degC																
Time	5±0.5 s																
Immersing Speed	25 mm/s																
Temperature characteristics	Inductance change: Within±15 % No abnormality observed in appearance.	Measurement shall be taken in a temperature range of -25 degC to +85 degC and the value at +20 degC was used as the standard value.															
Thermal shock	Inductance change: Within±10 % No abnormality observed in appearance.	The test samples shall be soldered to the testing jig and by reflow soldering conditions as shown in table 6. The test samples shall be left for the specified time at each of temperature in steps from 1 to 4, as shown in under table in sequence. The temperature cycles shall be repeated 100 cycles in the Method. Conditions for 1 cycle. <table border="1" style="margin-left: auto; margin-right: auto;"> <tr> <th>Step</th> <th>Temperature</th> <th>Time (min)</th> </tr> <tr> <td>1</td> <td>-40±3 degC</td> <td>30±3</td> </tr> <tr> <td>2</td> <td>Room Temp.</td> <td>within 3</td> </tr> <tr> <td>3</td> <td>85±2 degC</td> <td>30±3</td> </tr> <tr> <td>4</td> <td>Room Temp</td> <td>within 3</td> </tr> </table>	Step	Temperature	Time (min)	1	-40±3 degC	30±3	2	Room Temp.	within 3	3	85±2 degC	30±3	4	Room Temp	within 3
Step	Temperature	Time (min)															
1	-40±3 degC	30±3															
2	Room Temp.	within 3															
3	85±2 degC	30±3															
4	Room Temp	within 3															

	<b>Table 3</b>	
	STANDARDS	( 6 / 1 1 )

	Item	Standard	Test method							
<b>ENVIRONMENT TESTS</b>	Low temperature life test	Inductance change: Within±10 % No abnormality observed in appearance.	The test samples shall be soldered to the testing jig and by reflow soldering conditions as shown in table 6. And after that proceed the test as shown condition under table. <table border="1" style="margin-left: auto; margin-right: auto;"> <tr> <td>Temperature</td> <td>-40±2 degC</td> </tr> <tr> <td>Time</td> <td>1 000+24 h</td> </tr> </table>	Temperature	-40±2 degC	Time	1 000+24 h			
	Temperature	-40±2 degC								
	Time	1 000+24 h								
	High temperature life test	Inductance change: Within±10 % No abnormality observed in appearance.	The test samples shall be soldered to the testing jig and by reflow soldering conditions as shown in table 6. And after that proceed the test as shown condition under table. <table border="1" style="margin-left: auto; margin-right: auto;"> <tr> <td>Temperature</td> <td>85±2 degC</td> </tr> <tr> <td>Time</td> <td>1 000+24 h</td> </tr> </table>	Temperature	85±2 degC	Time	1 000+24 h			
Temperature	85±2 degC									
Time	1 000+24 h									
Damp heat life test	Inductance change: Within±10 % No abnormality observed in appearance.	The test samples shall be soldered to the testing jig and by reflow soldering conditions as shown in table 6. The test samples shall be put in thermostatic oven set at temperature with humidity, as shown in under table. <table border="1" style="margin-left: auto; margin-right: auto;"> <tr> <td>Temperature</td> <td>60±2 degC</td> </tr> <tr> <td>Humidity</td> <td>90~95 %RH</td> </tr> <tr> <td>Time</td> <td>1 000+24 h</td> </tr> </table>	Temperature	60±2 degC	Humidity	90~95 %RH	Time	1 000+24 h		
Temperature	60±2 degC									
Humidity	90~95 %RH									
Time	1 000+24 h									
Loading under damp heat life test	Inductance change: Within±10 % No abnormality observed in appearance.	The test samples shall be soldered to the testing jig and by reflow soldering conditions as shown in table 6. The test samples shall be put in thermostatic oven set at temperature with humidity, as shown in under table, and with the rated current continuously applied. <table border="1" style="margin-left: auto; margin-right: auto;"> <tr> <td>Temperature</td> <td>60±2 degC</td> </tr> <tr> <td>Humidity</td> <td>90~95 %RH</td> </tr> <tr> <td>Current</td> <td>Refer to Table 1</td> </tr> <tr> <td>Time</td> <td>1 000+24 h</td> </tr> </table>	Temperature	60±2 degC	Humidity	90~95 %RH	Current	Refer to Table 1	Time	1 000+24 h
Temperature	60±2 degC									
Humidity	90~95 %RH									
Current	Refer to Table 1									
Time	1 000+24 h									

Standard measuring condition	Unless otherwise specified, at least 2 hrs of recovery under the room temperature and normal humidity after the test, followed by the measurement within 48 hrs.
------------------------------	--

Table 4

TAPING DIMENSIONS

(7/11)

1. Dimensions

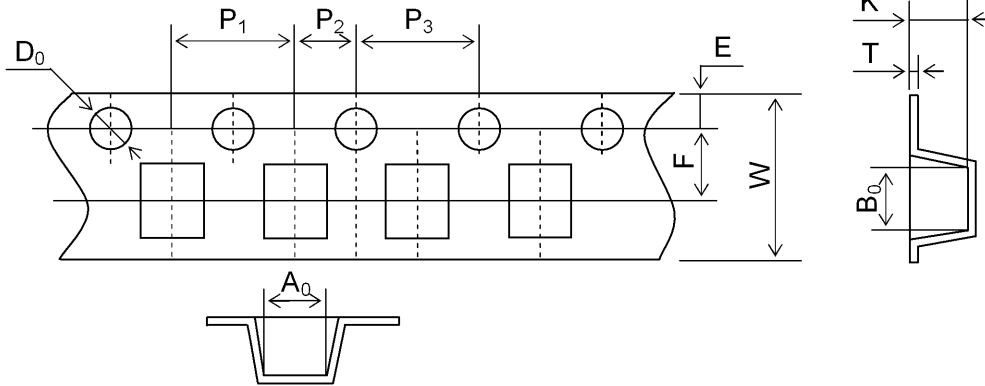

Unit : mm

$A_0$	$B_0$	$W$	$F$	$E$	$P_1$	$P_2$	$P_3$	$D_0$	$T$	$K$
1.80 $\pm 0.10$	2.80 $\pm 0.10$	8.00 $\pm 0.20$	3.50 $\pm 0.05$	1.75 $\pm 0.10$	4.00 $\pm 0.10$	2.00 $\pm 0.05$	4.00 $\pm 0.10$	$\phi 1.50$ $+0.10$ $-0$	0.25 $\pm 0.05$	1.45 max

2. Direction of rolling

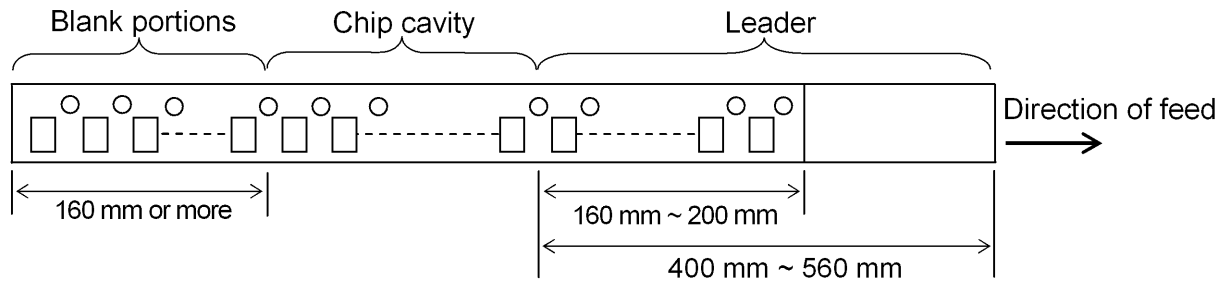

3. Reel

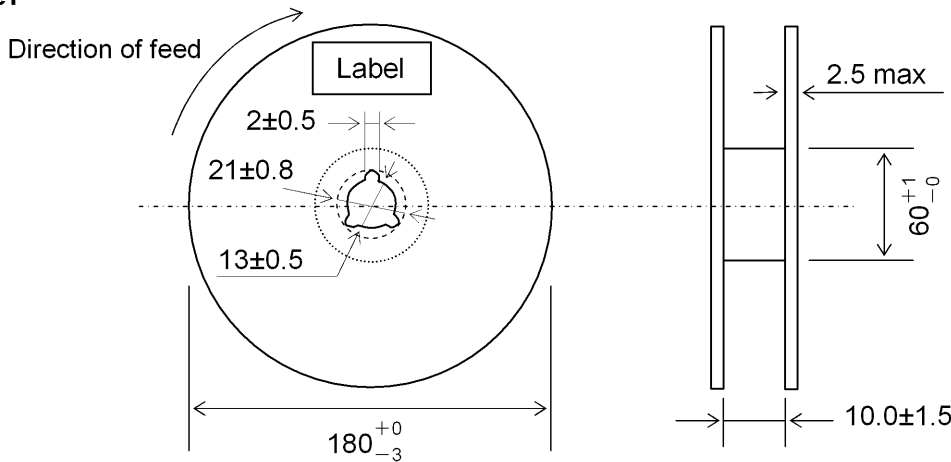

Unit : mm

Label position : the opposite side of pilot holes

4. Top tape strength

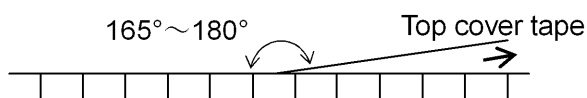

- Peel-off strength : 0.2 N ~ 0.7 N
- Peel-off angle :  $165^\circ \sim 180^\circ$
- Peel-off speed : 300 mm/min



	<b>Table 5</b>	
	PACKING FORM	( 8 / 1 1 )

**1. The number of components**

Each reel shall accommodate 3,000 inductors whether there are empty compartments or not.

**2. Packing in tape**

Emboss carrier tapes of 8 mm width, 4 mm pitch and  $\phi$ 180 mm-reels shall be used.

**3. The allowable number of empty components**

The number of empty compartments in a reel, which shall not appear continuously, must be limited to 2.

**4. Marking**

The following items shall be marked legibly each unit pack.

- (1) Customer parts No.
- (2) Our parts No.
- (3) Manufacture's name (TAIYO YUDEN CO., LTD.)
- (4) Control No.
- (5) Date (stamp)
- (6) Quantity
- (7) Country of the origin

**5. Dimensions of packing box (taping)**

\* Reference

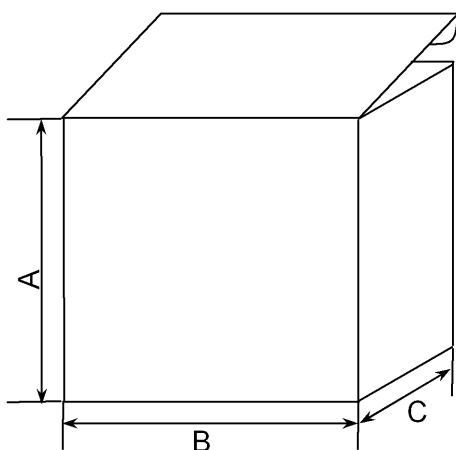

Code	A	B	C	Standard Quantity
Size	190	185	75	15, 000 pcs. max
			140	30, 000 pcs. max

[Unit : mm]

Table 6		
REFLOW PROFILE CHART (REFERENCE)		( 9 / 11 )

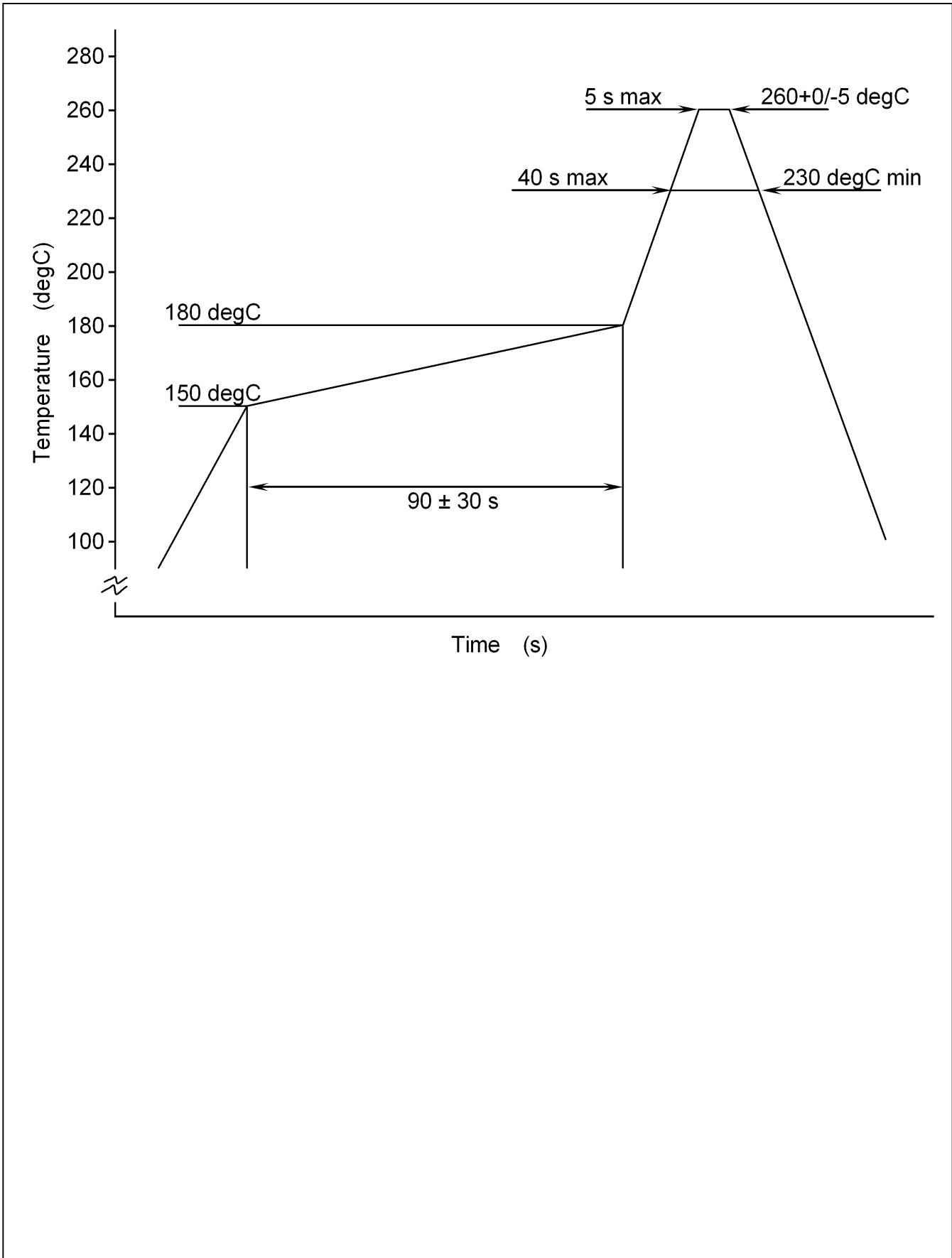

## Precautions

( 1 0 / 1 1 )

### 1. Surface Mounting

- Mounting and soldering conditions should be checked beforehand.
- This inductors only using reflow soldering.
- Recommended Land-Pattern and Metal Mask-Pattern (t = 0.10~0.12) :

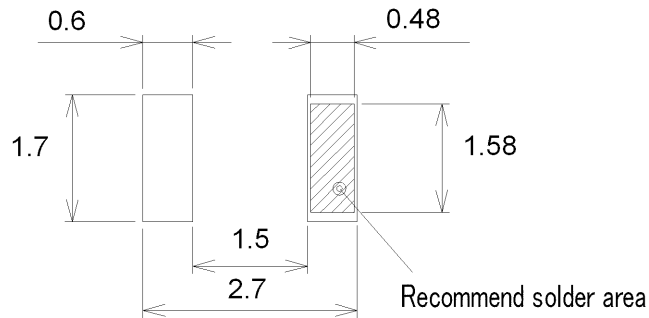

Unit : mm

- Recommended conditions for using a soldering iron:
  - Put the soldering iron on the land-pattern.
  - Soldering iron's temperature Below 350 degC
  - Duration 3 seconds or less
- The soldering iron should not directly touch the inductor.

### 2. Handling

- Keep the inductors away from all magnets and magnetic objects.
- When splitting the PC boards after mounting inductors, care should be taken not to give any stresses of deflection or twisting to the board.
- Board separation should not be done manually, but by using the appropriate devices.
- Please do not give the inductors any excessive mechanical shocks.
- Please avoid operation, which apply excessive stress and/or temperature to the products, such as resin molding.
- Washing by supersonic waves shall be avoided.

### 3. Storage

- To maintain the solder ability of terminal electrodes and to keep the packing material in good condition, temperature and humidity in the storage area should be controlled.

Recommended conditions.

Ambient temperature 0 ~ 40 degC

Humidity Below 70 % RH

The ambient temperature must be kept below 30 degC. Even under ideal storage conditions, solder ability of products electrodes may decrease as time passes, so inductors should be used within 6 months from the time of delivery.

### 4. Regulations

- No ozone-depleting substances, which are defined as Class-1 and Class-2 in the US Federal Clean Air Act, are used in the production processes, nor contained in the product.
- The product and the specifications described above are not included in the list of export regulations in Japan and USA.
- The product and the specifications described above are conformable to "RoHS compliance". "RoHS compliance" means that the product does not contain lead, cadmium, mercury, hexavalent chromium, PBBs or PBDEs referring to EU Directive 2002/95/EC, except other non-restricted substances or impurities which could not be technically removed at the refining process.

**5. Production Sites**

- TAIYO YUDEN CO., LTD. (JAPAN)
- CHUKI SEIKI CO., LTD. (JAPAN)
- Tsukiyono Denshi Co., Ltd. (JAPAN)

**6. Guarantee**

The operating conditions for the guarantee of this product are as shown in the drawing for specification.

Please note that Taiyo Yuden Co., Ltd. shall not be responsible for a failure and /or abnormality which is caused by use under the conditions other than the aforesaid operating conditions.

**[ SPECIAL NOTICE ]**

■All of the contents specified here are subject to change without notice due to technical improvements, etc. Therefore, please check latest version of the components specifications carefully before practical application or usage of the components.

Please note that Taiyo Yuden Co., Ltd. shall not be responsible for any defects in products or equipment incorporating such products, which are caused under the conditions other than those specified in this specification or individual specification.

■Please conduct validation and verification of products in actual condition of mounting and operating environment before commercial shipment of the equipment.

■All electronic components in this specification are developed, designed and intended for use in general electronics equipment.(for AV, office automation, household, office supply, information service, telecommunications, (such as mobile phone or PC) etc.).

Before incorporating the components or devices into any equipment in the field such as transportation,( automotive control, train control, ship control), transportation signal, disaster prevention, medical, public information network (telephone exchange, base station) etc. which may have direct influence to harm or injure a human body, please contact Taiyo Yuden Co., Ltd. for more detail in advance.

Do not incorporate the products into any equipment in fields such as aerospace, aviation, nuclear control, submarine system, military, etc. where higher safety and reliability are especially required.

In addition, even electronic components or functional modules that are used for the general electronic equipment, if the equipment or the electric circuit require high safety or reliability function or performances, a sufficient reliability evaluation check for safety shall be performed before commercial shipment and moreover, due consideration to install a protective circuit is strongly recommended at customer's design stage.

■The contents of this specification are applicable to the products which are purchased from our sales offices or distributors (so called "TAIYO YUDEN's official sales channel")

It is only applicable to the products purchased from any of TAIYO YUDEN's official sales channel.

■Please note that Taiyo Yuden Co., Ltd. shall have no responsibility for any controversies or disputes that may occur in connection with a third party's intellectual property rights and other related rights arising from your usage of products in this specification. Taiyo Yuden Co., Ltd. grants no license for such rights.