



AUDIO JACKS: STX-3100 Series PCB Mount 3.5mm Audio Jack

Product Features

Audio Applications for Computers and Multimedia
Can Be Used To Activate Speakers, an Equalizer or to
Configure the Audio Signal
Available with Up to One Double-Pole Single-Throw Switch &
One Double-Pole Double-Throw Switch in One Audio Jack
CSA/NRTL Certified File No. LR78160

Performance Specifications

Materials and Finish

Housing

PBT Thermoplastic, Black Color, UL94V-0 Rated

Bushing

Brass, Nickel Plated

Terminals

Pin #1: Brass, Nickel Plated
Pin #5 and Pin #2: Phosphor Bronze, Matte Tin Plated
Pin #3 and Pin #4: Brass, Matte Tin Plated
Slide Switch Terminals: Brass, Silver Plated

Mechanical Characteristics

Insertion Force

0.4kg - 2.0kg

Extraction Force

0.3kg - 2.0kg

Durability

5000 Mating Cycles

Electrical Characteristics

Contact Resistance

Before Durability Test

30 milliohms Max.

After Durability Test

60 milliohms Max.

Insulation Resistance

100 Megohms Min. at 250V DC

Dielectric Withstanding Voltage

250V AC RMS for 1 Minute

Operating Temperature

-25°C to + 85°C

2D Drawing	IGES	STEP	3D PDF
Solder Profile	CofC RoHS Compliant	CofC REACH Compliant	UL Plastic File
Certificate of Origin	Check Stock	Request a Sample	Send Us An Email

Generated Part Number

Part Number Builder

	-			
Series		Number of Pins	Threading Option	Back Plate Option

Series

STX-3100 - 3.5mm Audio Jack

Number of Pins

3 Pins - Audio Jack, No Switch
5 Pins - One Double-Pole Single-Throw Switch
9 Pins - One Double-Pole Double-Throw Switch
11 Pins - One Double-Pole Single-Throw Switch/
One Double-Pole Double-Throw Switch

Threading Option

C - Threaded Barred
N - Non-Threaded Barred

Back Plate Option

Blank - No Back Plate
B - With Back Plate (Available only with 3 & 5 Pins Option)

Contact Kycon for other options

STX-3100-3C

Dimensions in mm

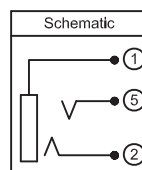
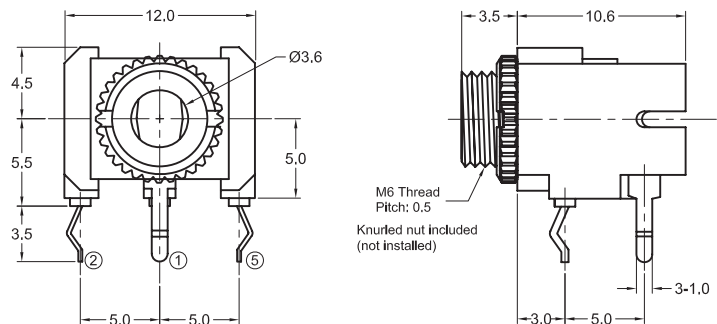

Mouser Electronics

Authorized Distributor

Click to View Pricing, Inventory, Delivery & Lifecycle Information:

[Kycon:](#)

[STX-3100-9N](#) [STX-3100-9C](#) [STX-3100-3N](#) [STX-3100-3C](#) [STX-3100-5N](#) [STX-3100-5C](#) [STX-3100-3CB](#) [STX-3100-3NB](#) [STX-3100-11N](#) [STX-3100-11C](#) [STX-3100-5NB](#) [STX-3100-5CB](#) [STX-3100-3N-577C](#)