

TURBOSWITCH™ "A". ULTRA-FAST HIGH VOLTAGE DIODE

MAIN PRODUCTS CHARACTERISTICS

$I_{F(AV)}$	2*30A
V_{RRM}	600V
t_{rr} (typ)	35ns
V_F (max)	1.5V

FEATURES AND BENEFITS

- SPECIFIC TO "FREEWHEEL MODE" OPERATIONS: Freewheel or Booster Diode
- ULTRA-FAST RECOVERY.
- VERY LOW OVERALL POWER LOSSES IN BOTH THE DIODE AND THE COMPANION TRANSISTOR.
- HIGH FREQUENCY OPERATIONS.

DESCRIPTION

The TURBOSWITCH is a very high performance series of ultra-fast high voltage power diodes from 600V to 1200V.

TURBOSWITCH, A family, drastically cuts losses in both the diode and the associated switching IGBT or MOSFET in all "Freewheel Mode" operations and is particularly suitable and efficient

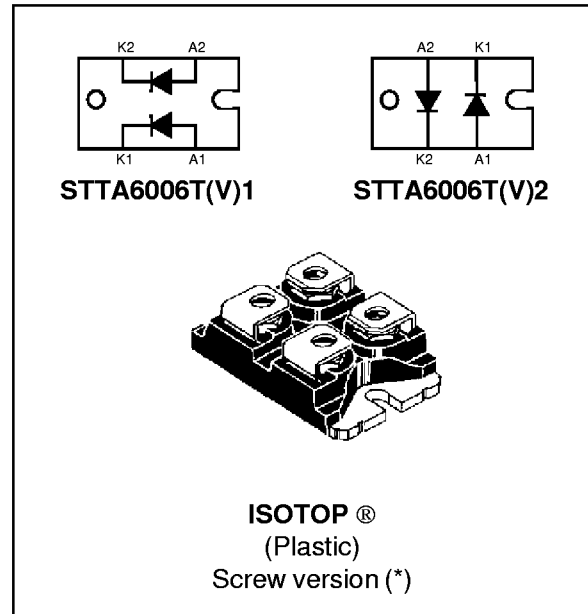

in Motor Control Freewheel applications and in Booster diode applications in Power Factor Control circuitries.

Packaged in ISOTOP, these 600V devices are particularly intended for use on 240V domestic mains.

ABSOLUTE MAXIMUM RATINGS

Symbol	Parameter	Value	Unit
V_{RRM}	Repetitive peak reverse voltage.	600	V
V_{RSM}	Non repetitive peak reverse voltage.	600	V
$I_{F(RMS)}$	RMS forward current.	50	A
I_{FRM}	Repetitive peak forward current ($t_p = 5 \mu s$, $f = 5 kHz$)	300	A
T_j	Max operating junction temperature.	-65 to 150	°C
T_{stg}	Storage temperature.	-65 to 150	°C

(*) : Tin plated Fast-on version is also available (without V suffix).

TM : ISOTOP and TURBOSWITCH are trademarks of SGS-THOMSON MICROELECTRONICS

STTA6006T(V)1/2

THERMAL AND POWER DATA

Symbol	Parameter	Conditions	Value	Unit
$R_{th(j-c)}$	Junction to case thermal resistance	Per diode	1.4	°C/W
		Total	0.75	
		Coupling	0.1	
P_1	Conduction power dissipation (see fig. 2)	Per diode $I_{F(AV)} = 30A$ $\delta = 0.5$ $T_c = 74^\circ C$	54	W
P_{max}	Total power dissipation $P_{max} = P_1 + P_3$ ($P_3 = 10\% P_1$)	Per diode $T_c = 66^\circ C$	60	W

STATIC ELECTRICAL CHARACTERISTICS (see Fig.2)

Symbol	Parameter	Test Conditions		Min	Typ	Max	Unit
V_F *	Forward voltage drop	$I_F = 30A$	$T_j = 25^\circ C$			1.75	V
			$T_j = 125^\circ C$			1.5	V
I_R **	Reverse leakage current	$V_R = 0.8$ $\times V_{RRM}$	$T_j = 25^\circ C$			150	μA
			$T_j = 125^\circ C$			8	mA

Test pulses widths : * $t_p = 380 \mu s$, duty cycle < 2%

** $t_p = 5 ms$, duty cycle < 2%

DYNAMIC ELECTRICAL CHARACTERISTICS

TURN-OFF SWITCHING (see Fig.3)

Symbol	Parameter	Test Conditions	Min	Typ	Max	Unit
t_{rr}	Reverse recovery time	$T_j = 25^\circ C$ $I_F = 0.5 A$ $I_R = 1A$ $I_{rr} = 0.25A$ $I_F = 1 A$ $di_F/dt = -50A/\mu s$ $V_R = 30V$		35	65	ns
I_{RM}	Maximum reverse recovery current	$T_j = 125^\circ C$ $V_R = 400V$ $I_F = 30A$ $di_F/dt = -240 A/\mu s$ $di_F/dt = -500 A/\mu s$		20	19	A
S factor	Softness factor	$T_j = 125^\circ C$ $V_R = 400V$ $I_F = 30A$ $di_F/dt = -500 A/\mu s$		0.40		/

TURN-ON SWITCHING (see Fig.4)

Symbol	Parameter	Test Conditions	Min	Typ	Max	Unit
t_{fr}	Forward recovery time	$T_j = 25^\circ C$ $I_F = 30A$, $di_F/dt = 240 A/\mu s$ measured at, $1.1 \times V_{Fmax}$			600	ns
V_{Fp}	Peak forward voltage	$T_j = 25^\circ C$ $I_F = 30A$, $di_F/dt = 240 A/\mu s$			12	V

APPLICATION DATA

The TURBOSWITCH "A" is especially designed to provide the lowest overall power losses in any "FREEWHEEL Mode" application (Fig.1) considering both the diode and the companion

transistor, thus optimizing the overall performance in the end application.

The way of calculating the power losses is given below:

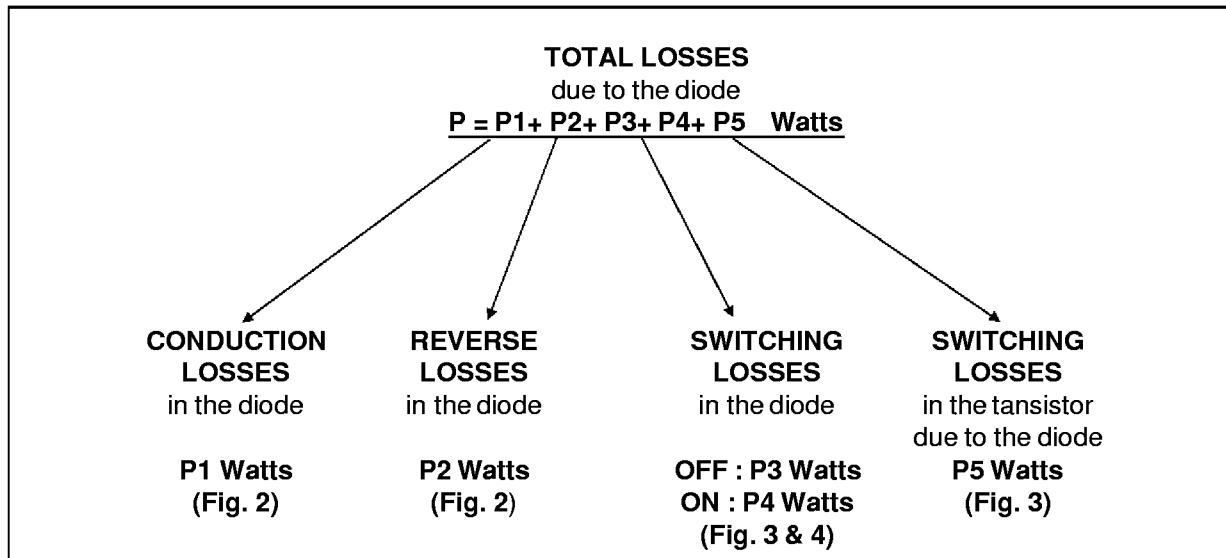
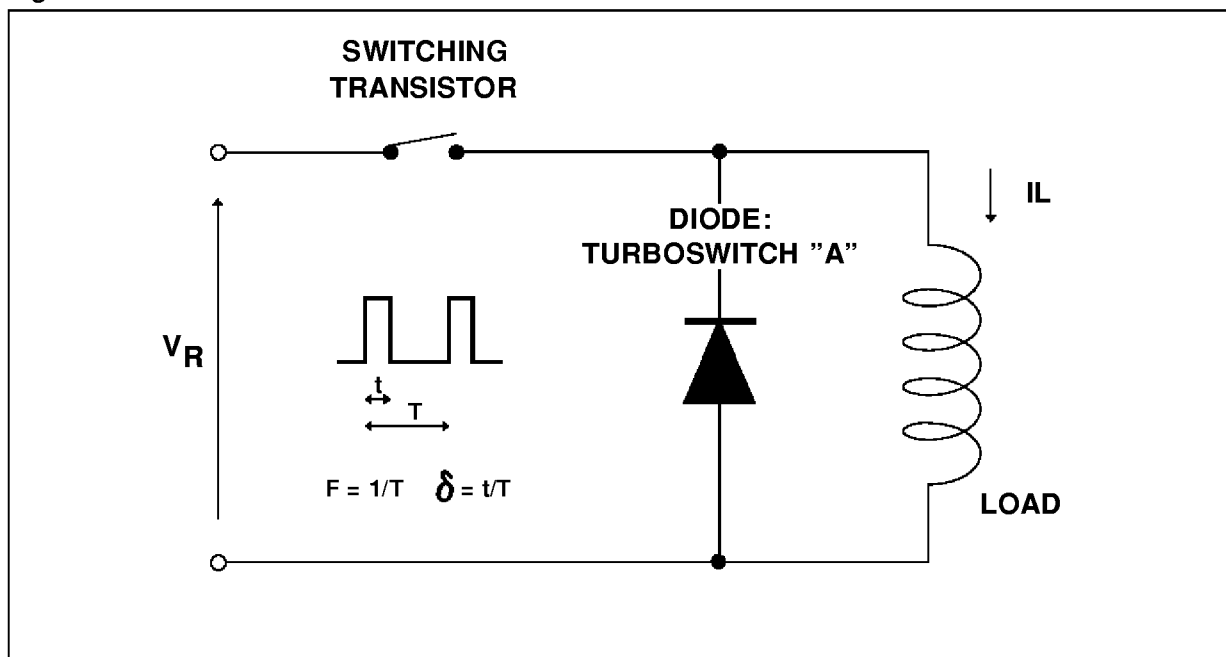
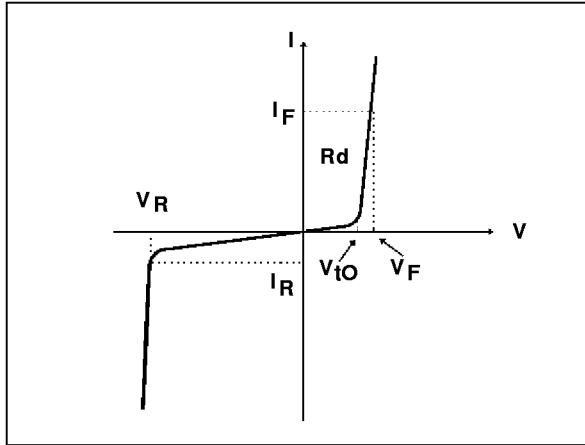

Fig. 1 : "FREEWHEEL" MODE.



APPLICATION DATA (Cont'd)

Fig. 2: STATIC CHARACTERISTICS



Conduction losses :

$$P1 = V_{t0} \cdot I_F(AV) + R_d \cdot I_F^2(RMS)$$

with

$$V_{t0} = 1.15 \text{ V}$$

$$R_d = 0.011 \text{ Ohm}$$

(Max values at 125°C)

Reverse losses :

$$P2 = V_R \cdot I_R \cdot (1 - \delta)$$

Fig. 3: TURN-OFF CHARACTERISTICS

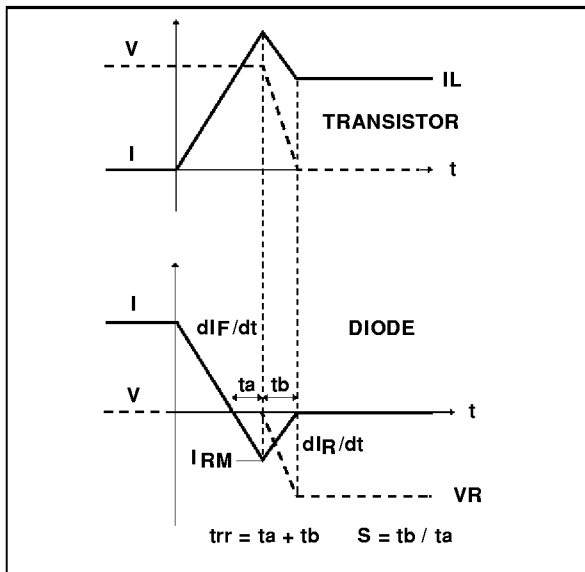

Turn-on losses :

(in the transistor, due to the diode)

$$P5 = \frac{V_R \times I_{RM}^2 \times (3 + 2 \times S) \times F}{6 \times dI_F/dt} + \frac{V_R \times I_{RM} \times I_L \times (S + 2) \times F}{2 \times dI_F/dt}$$

Turn-off losses (in the diode) :

$$P3 = \frac{V_R \times I_{RM}^2 \times S \times F}{6 \times dI_F/dt}$$

P3 and P5 are suitable for power MOSFET and IGBT

Fig. 4: TURN-ON CHARACTERISTICS

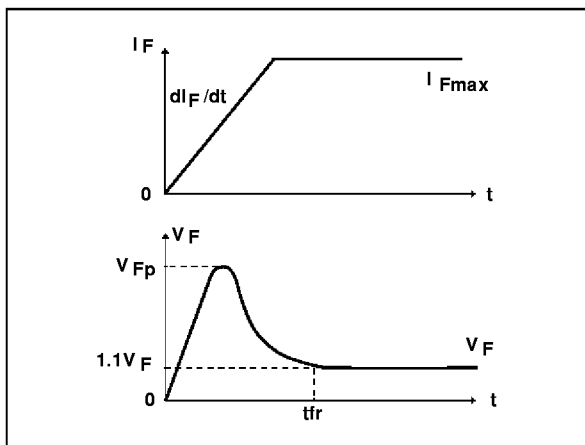

Turn-on losses :

$$P4 = 0.4 (V_{FP} - V_F) \cdot I_{Fmax} \cdot t_{fr} \cdot F$$

Fig 5 : Conduction losses versus average current

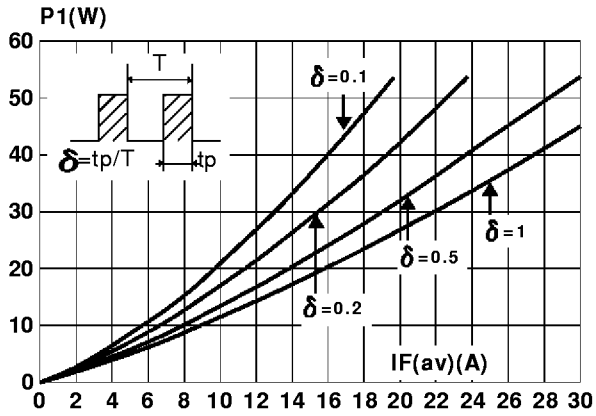

Fig 6 : Switching OFF losses versus dI/dt

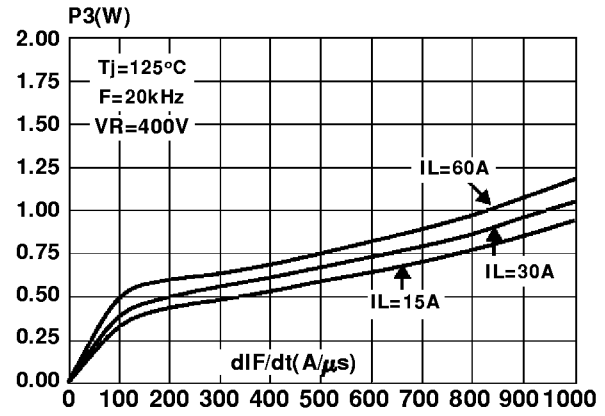

Fig 7 : Switching ON losses versus dI/dt

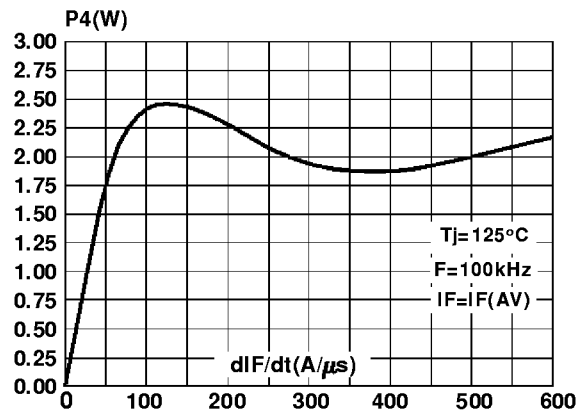

Fig 8 : Switching losses in transistor due to the diode

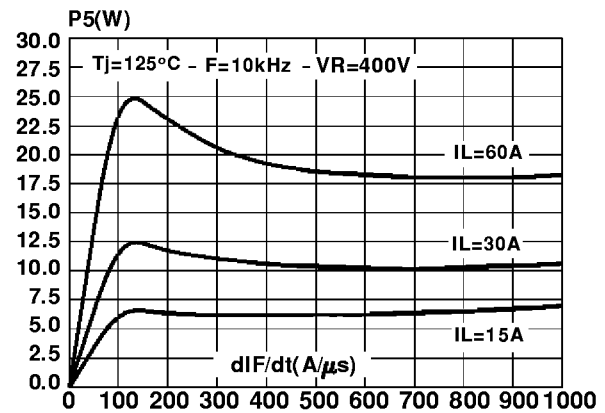

Fig 9 : Forward voltage drop versus forward current

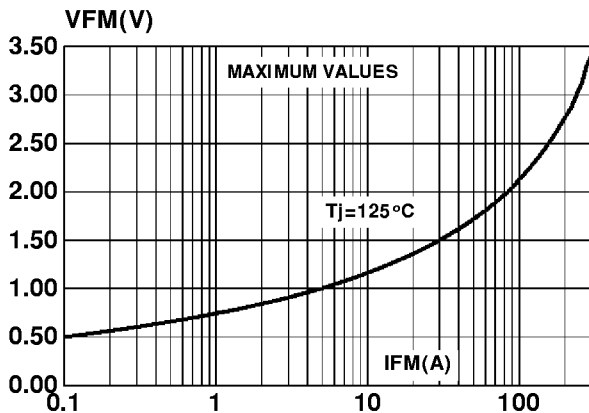

Fig 10 : Relative variation of thermal transient impedance junction to case versus pulse duration

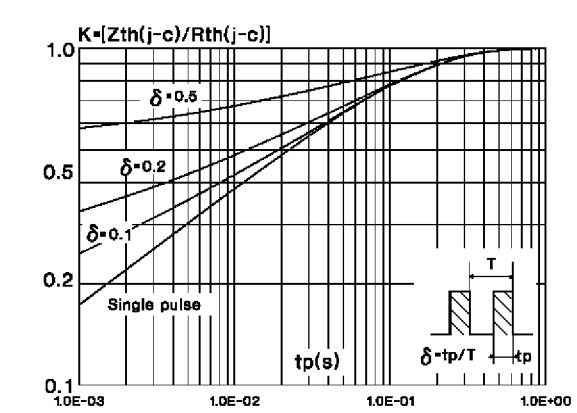

Fig 11 : Peak reverse recovery current versus dI_F/dt

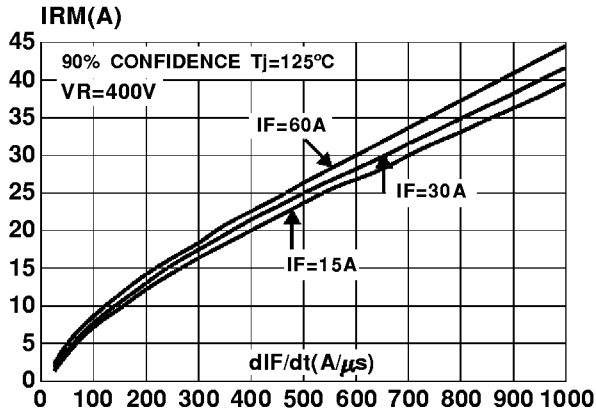

Fig 12 : Reverse recovery time versus dI_F/dt

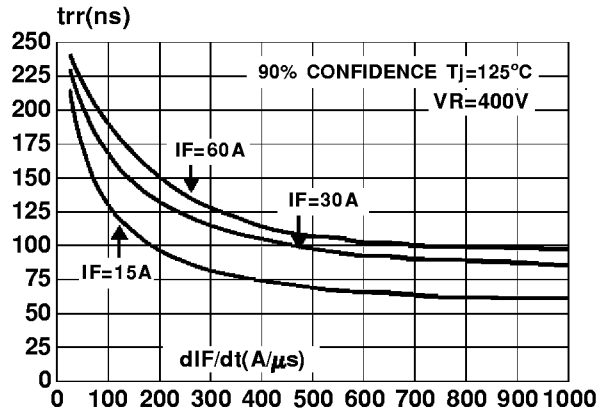

Fig 13 : Softness factor (t_b/t_a) versus dI_F/dt

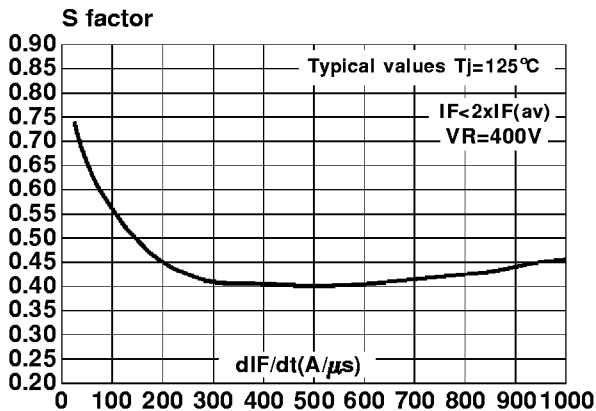

Fig 14 : Relative variation of dynamic parameters versus junction temperature (Reference $T_j=125^\circ C$)

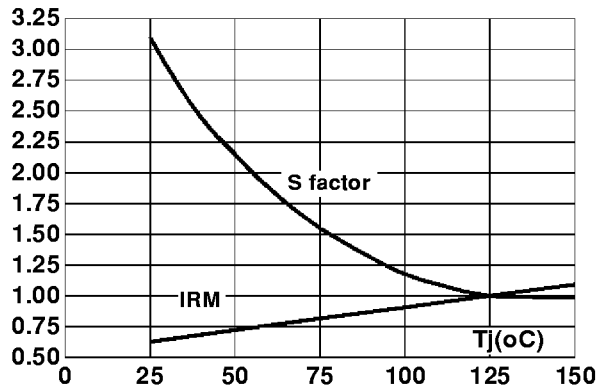

Fig 15 : Transient peak forward voltage versus dI_F/dt

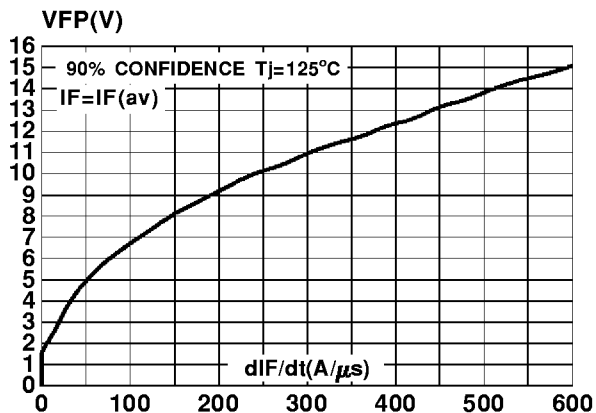
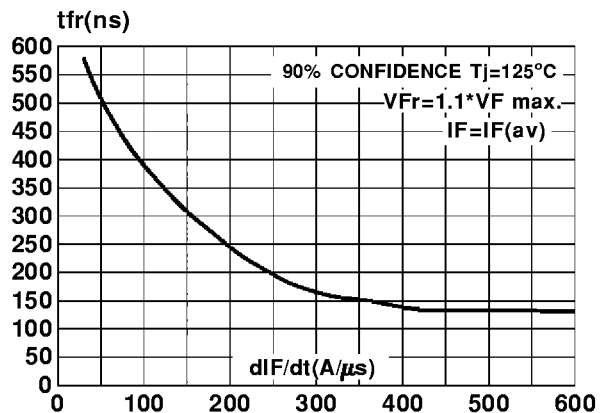
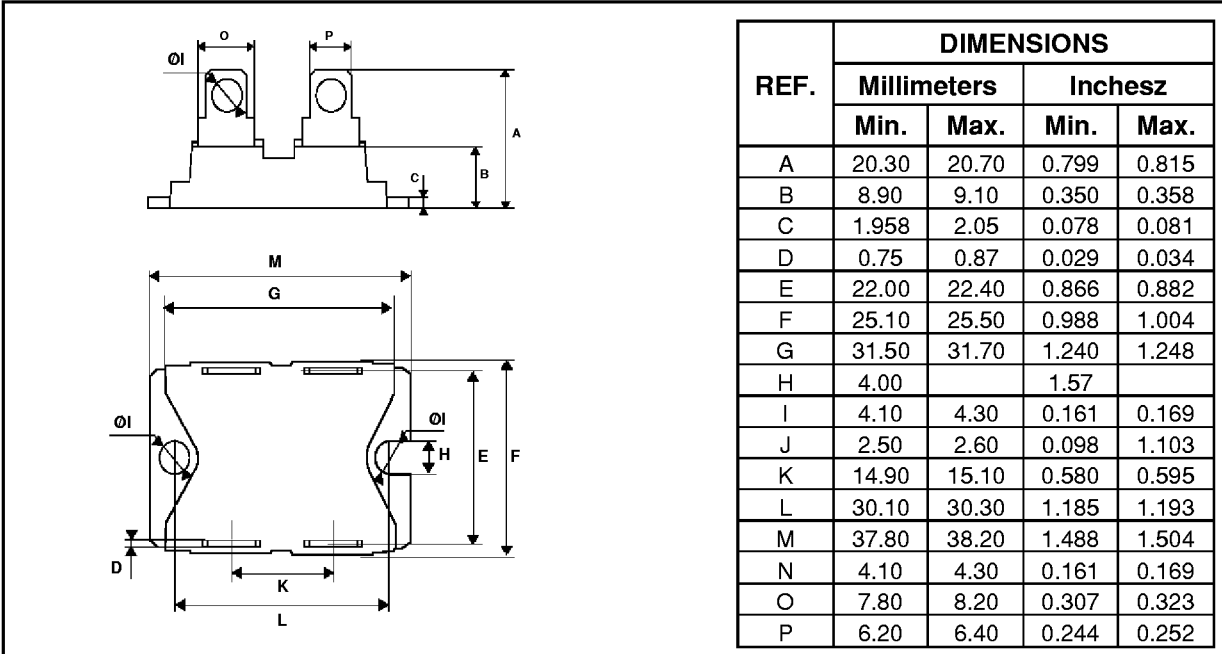

Fig 16 : Forward recovery time versus dI_F/dt



PACKAGE MECHANICAL DATA

ISOTOP Fast on version



Cooling method : C.
 Marking : Type number.
 Weight : 28 g. (without screws)

Cooling method : C.
 Marking : Type number.
 Weight : 28 g. (without screws)

PACKAGE MECHANICAL DATA

ISOTOP Screw version

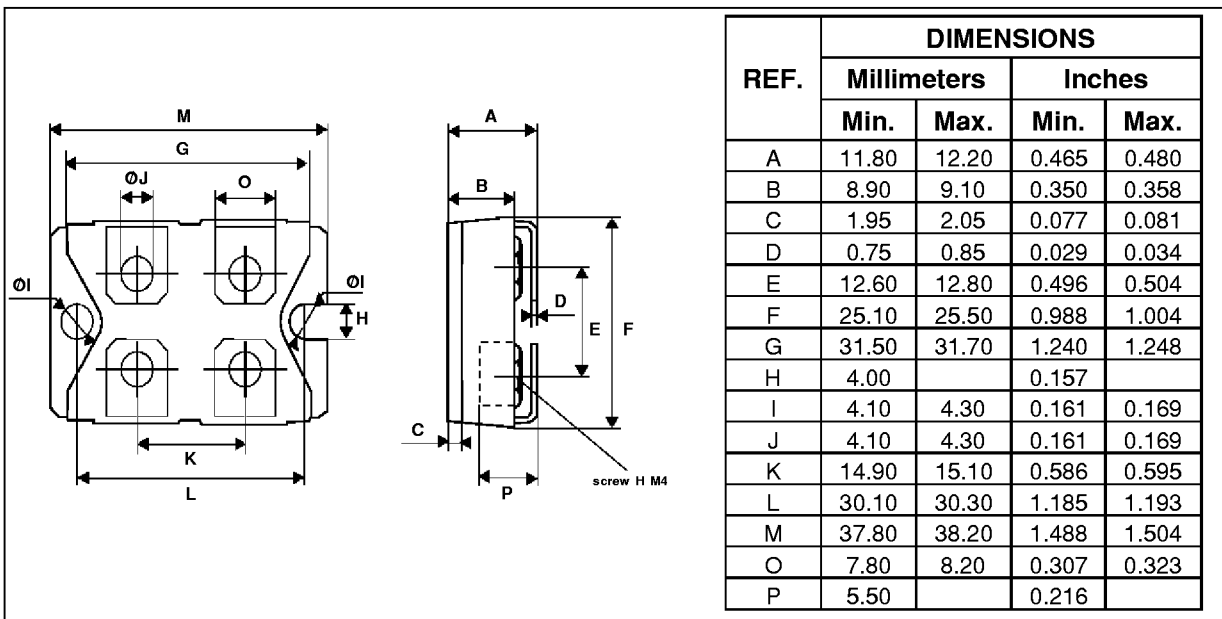

Cooling method : C
 Marking : Type number
 Weight : 28 g

Electrical isolation : 2500V(RMS)
 Capacitance : < 45pF
 Inductance : < 5nH

Information furnished is believed to be accurate and reliable. However, SGS-THOMSON Microelectronics assumes no responsibility for the consequences of use of such information nor for any infringement of patents or other rights of third parties which may result from its use. No license is granted by implication or otherwise under any patent or patent rights of SGS-THOMSON Microelectronics. Specifications mentioned in this publication are subject to change without notice. This publication supersedes and replaces all information previously supplied. SGS-THOMSON Microelectronics products are not authorized for use as critical components in life support devices or systems without express written approval of SGS-THOMSON Microelectronics.

© 1994 SGS-THOMSON Microelectronics - All Rights Reserved

Purchase of I²C Components by SGS-THOMSON Microelectronics, conveys a licence under the Philips I²C Patent. Rights to use these components in an I²C system, is granted provided that the system conforms to the I²C Standard Specification as defined by Philips.

SGS-THOMSON Microelectronics GROUP OF COMPANIES
Australia - Brazil - France - Germany - Hong Kong - Italy - Japan - Korea - Malaysia - Malta - Morocco - The Netherlands -
Singapore - Spain - Sweden - Switzerland - Taiwan - Thailand - United Kingdom - U.S.A