



## ME2101 Series

Ver 02

# ME2101 Series Step-up DC-DC Converter

**ME2101 Series** is a PWM Step-up DC/DC converter IC with low supply current by CMOS process. High frequency noise that occurs during switching is reduced by using advanced circuit designed, output voltage is programmable in 0.1V steps between 2.0~5.0V and maximum frequency is 100KHz(Typ.). A low ripple, high efficiency step-up DC/DC converter can be constructed of ME2101AxxX with only three external components. Also available is a CE(chip enable) function that reduce power dissipation During shut-down mode., and an independent Vdd pin function (separated power supply and voltage detect pins) for fly-back circuits. An inner soft-start circuit limits current surges from input power supply at start up and the reliability of the chip is improved. ME2101XxxX is suitable for use with battery-powered instruments with low noise and low supply current.

## Features

- Small number of external components: only an inductor, a diode and a capacitor;
- Low ripple and low noise;
- Operating voltage range: 0.9V~6.5V;
- Output voltage range: 2.0V~5.0V(step 0.1V);
- Output voltage accuracy:  $\pm 2.5\%$ ;
- Output Current: if  $V_{in}=3.0V$  and  $V_{out}=3.3V$ , then  $I_{out}=350mA$ ;
- Low start voltage:  $\leq 0.9V$ (at  $I_{out}=1mA$ );
- Maximum oscillator frequency: 100KHz(Typ.);
- High Efficiency: 87%(Type);
- Slow-Start Time : 15mS(Type);
- PACKAGE: SOT-23, SOT-89.

## Applications

- Power source for battery-powered equipment;
- Power source for wireless mouse, wireless keyboard, toys, cameras, camcorders, VCRs, PDAs, and hand-held communication equipment;
- Power source for appliances which require higher cell voltage than that of batteries used in the appliances.

## Selection Guide

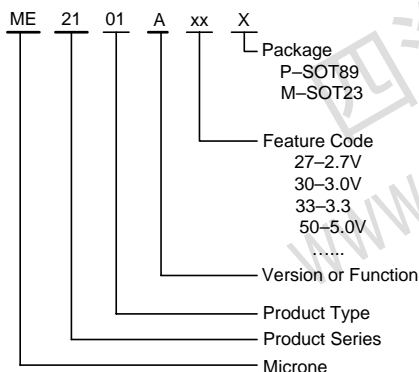

TYPE	POSTFIX	PACKAGE	SWITCHING TRANSISTOR	CE FUNCTION	FEATURES
ME2101Axx	M	SOT-23-3	Build_in Transistor	No	Lx
	P	SOT-89-3	External Transistor	No	Ext
ME2101Bxx	M	SOT-23-3	Build_in Transistor	No	Lx
	P	SOT-89-3	External Transistor	No	Ext
ME2101Cxx	M	SOT-23-5	Build_in Transistor	Yes	Lx+CE
	P	SOT-89-5	External Transistor	Yes	Ext+CE
ME2101Dxx	M	SOT-23-5	Build_in Transistor	Yes	Lx+CE
	P	SOT-89-5	External Transistor	Yes	Ext+CE

## Pin Configuration

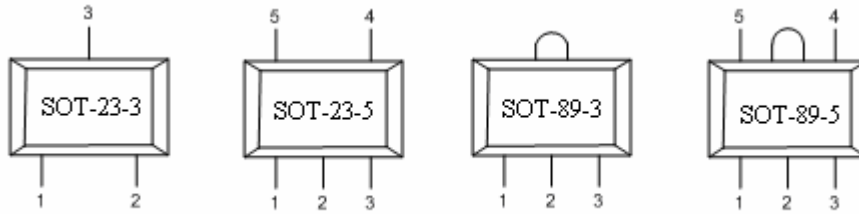

## Pin Assignment

### ME2101Axx

PIN Number		PIN NAME	FUNCTION
SOT-23-3	SOT-89-3		
1	1	Vss	Ground
3	2	Vout	Output voltage monitor, IC internal power supply
2	3	Lx	Switch

### ME2101Bxx

PIN Number		PIN NAME	FUNCTION
SOT-23-3	SOT-89-3		
1	1	Vss	Ground
3	2	Vout	Output voltage monitor, IC internal power supply
2	3	Ext	External switch transistor drive

### ME2101Cxx

PIN Number		PIN NAME	FUNCTION
SOT-23-5	SOT-89-5		
4	5	Vss	Ground
2	2	Vout	Output voltage monitor, IC internal power supply
5	4	Lx	Switch
1	3	CE	Chip enable
3	1	NC	NC

### ME2101Dxx

PIN Number		PIN NAME	FUNCTION
SOT-23-5	SOT-89-5		
4	5	Vss	Ground
2	2	Vout	Output voltage monitor, IC internal power supply
5	4	Ext	External switch transistor drive
1	3	CE	Chip enable
3	1	NC	NC

## Block Diagram

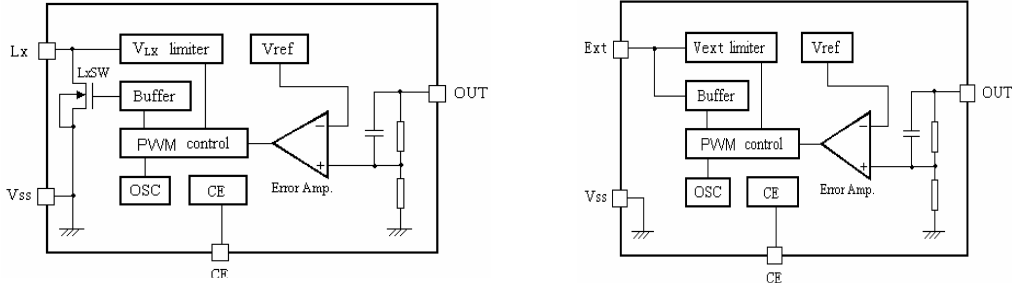

## Absolute Maximum Ratings

PARAMETER	SYMBOL	RATINGS	UNITS	
$V_{IN}$ Input Voltage	$V_{IN}$	6.5	V	
Lx Pin voltage	$V_{LX}$	6.5	V	
EXT Pin voltage	$V_{EXT}$	-0.3~ $V_{out}+0.3$	V	
CE Pin voltage	$V_{CE}$	-0.3~ $V_{out}+0.3$	V	
Lx Pin current	$I_{LX}$	600	mA	
EXT Pin current	$I_{EXT}$	$\pm 30$	mA	
Vdd input voltage	$V_{dd}$	6.5	V	
Continuous Total Power Dissipation	SOT-23	$P_d$	300	mW
	SOT-89	$P_d$	500	mW
Operating Ambient Temperature	$T_{Opr}$	-25~+85	$^{\circ}C$	
Storage Temperature	$T_{stg}$	-40~+125	$^{\circ}C$	
Soldering temperature and time	$T_{solder}$	260 $^{\circ}C$ , 10s		

## Electrical Characteristics

**ME2101A30**  $V_{out}=3.0V, F_{osc}=100kHz$

SYMB-OL	PARAMETER	CONDITIONS	MIN	TYP	MAX	UNITS
$V_{OUT}$	Output Voltage		2.925	3.000	3.075	V
$V_{IN}$	Maximum Input Voltage				6.5	V
$V_{start}$	Oscillation Start-up Voltage	$I_{OUT}=1mA,$ $V_{IN}: 0 \rightarrow 2V$		0.8	0.9	V
$V_{hold}$	Oscillation Hold Voltage	$I_{OUT}=1mA,$ $V_{IN}: 2 \rightarrow 0V$		0.24		V
$I_{DD1}$	Supply Current 1	No external component $V_{out}=V_{out} \times 0.95,$		30		$\mu A$
$I_{DD2}$	Supply Current 2	$V_{out}=V_{out}+0.5V$		11		$\mu A$
$I_{LX}$	Lx Switching Current	$V_{LX}=0.4V,$ $V_{out}=V_{out} \times 0.95$		250		mA
$I_{LXleak}$	Lx Leakage Current	$V_{out}=V_{LX}=6V$			0.5	$\mu A$
$I_{EXTH}$	EXT"High" On Current	Same as $I_{DD1}.$ $V_{EXT}=V_{out}-0.4V,$		-6		mA
$I_{EXTL}$	EXT"Low" On Current	Same as $I_{DD1}.$ $V_{EXT}=0.4V,$		14		mA
$V_{CEH}$	CE"High" Voltage	$V_{out}=V_{ce}=\text{set } V_{out} \times 0.95$	0.70			V
$V_{CEL}$	CE"Low" Voltage	$V_{out}=V_{ce}=\text{set } V_{out} \times 0.95$			0.20	V
$I_{CEH}$	CE"High" Current	$V_{out}=6.0V, V_{ce}=6.0V$			0.25	$\mu A$
$I_{CEL}$	CE"low" Current	$V_{out}=6.0V, V_{ce}=0.0V$			-0.25	$\mu A$
$F_{osc}$	Oscillation Frequency	$V_{out}=\text{set } V_{out} \times 0.95$		100		kHz
Maxdty	Duty Ratio	on( $V_{LX}$ "L" )side	80	87	92	%
EFFI	Efficiency			87		%
Tss	Slow-Start Time		5	15	25	mS

Measuring conditions: Unless otherwise specified,  $V_{IN}=V_{out} \times 0.6,$   $V_{SS}=0V,$   $I_{OUT}=10mA,$   $T_{opt}=25^{\circ}C.$

Note: 1、Diode use Schottky diode such as IN5817 or IN5819 (forward voltage drop:0.2V)

2、Inductor:  $47 \mu H$  ( $r < 0.5 \Omega$ )

3、Capacitor: Tantalum type  $47 \mu F$

## Electrical Characteristics

**ME2101A33**  $V_{out}=3.3V, F_{osc}=100kHz$

SYMB-OL	PARAMETER	CONDITIONS	MIN	TYP	MAX	UNITS
$V_{OUT}$	Output Voltage		3.218	3.300	3.382	V
$V_{IN}$	Maximum Input Voltage				6.5	V
$V_{start}$	Oscillation Start-up Voltage	$I_{OUT}=1mA,$ $V_{IN}: 0 \rightarrow 2V$		0.8	0.9	V
$V_{hold}$	Oscillation Hold Voltage	$I_{OUT}=1mA,$ $V_{IN}: 2 \rightarrow 0V$		0.24		V
$I_{DD1}$	Supply Current 1	No external component $V_{out}=V_{out} \times 0.95,$		35		$\mu A$
$I_{DD2}$	Supply Current 2	$V_{out}=V_{out}+0.5V$		13		$\mu A$
$I_{LX}$	Lx Switching Current	$V_{LX}=0.4V,$ $V_{out}=V_{out} \times 0.95$		260		mA
$I_{LXleak}$	Lx Leakage Current	$V_{out}=V_{LX}=6V$			0.5	$\mu A$
$I_{EXTH}$	EXT"High" On Current	Same as $I_{DD1}.$ $V_{EXT}=V_{out}-0.4V,$		-6		mA
$I_{EXTL}$	EXT"Low" On Current	Same as $I_{DD1}.$ $V_{EXT}=0.4V,$		14		mA
$V_{CEH}$	CE"High" Voltage	$V_{out}=V_{ce}=\text{set } V_{out} \times 0.95$	0.70			V
$V_{CEL}$	CE"Low" Voltage	$V_{out}=V_{ce}=\text{set } V_{out} \times 0.95$			0.20	V
$I_{CEH}$	CE"High" Current	$V_{out}=6.0V, V_{ce}=6.0V$			0.25	$\mu A$
$I_{CEL}$	CE"low" Current	$V_{out}=6.0V, V_{ce}=0.0V$			-0.25	$\mu A$
$F_{osc}$	Oscillation Frequency	$V_{out}=\text{set } V_{out} \times 0.95$		100		kHz
Maxdty	Duty Ratio	on( $V_{LX}$ "L" )side	80	87	92	%
EFFI	Efficiency			85		%
Tss	Slow-Start Time		5	15	25	mS

Measuring conditions: Unless otherwise specified,  $V_{IN}=V_{out} \times 0.6,$   $V_{SS}=0V,$   $I_{OUT}=10mA,$   $T_{opt}=25^{\circ}C.$

Note: 1、Diode use Schottky diode such as IN5817 or IN5819 (forward voltage drop:0.2V)

2、Inductor:  $47 \mu H$  ( $r < 0.5 \Omega$ )

3、Capacitor: Tantalum type  $47 \mu F$

## Electrical Characteristics

**ME2101A50**  $V_{out}=5.0V, F_{osc}=100kHz$

SYMB-OL	PARAMETER	CONDITIONS	MIN	TYP	MAX	UNITS
$V_{OUT}$	Output Voltage		4.875	5.000	5.125	V
$V_{IN}$	Maximum Input Voltage				6.5	V
$V_{start}$	Oscillation Start-up Voltage	$I_{OUT}=1mA,$ $V_{IN}: 0 \rightarrow 2V$		0.8	0.9	V
$V_{hold}$	Oscillation Hold Voltage	$I_{OUT}=1mA,$ $V_{IN}: 2 \rightarrow 0V$		0.24		V
$I_{DD1}$	Supply Current 1	No external component $V_{out}=V_{out} \times 0.95,$		70		$\mu A$
$I_{DD2}$	Supply Current 2	$V_{out}=V_{out}+0.5V$		26		$\mu A$
$I_{LX}$	Lx Switching Current	$V_{LX}=0.4V,$ $V_{out}=V_{out} \times 0.95$		290		mA
$I_{LXleak}$	Lx Leakage Current	$V_{out}=V_{LX}=6V$			0.5	$\mu A$
$I_{EXTH}$	EXT"High" On Current	Same as $I_{DD1}.$ $V_{EXT}=V_{out}-0.4V,$		-5.72		mA
$I_{EXTL}$	EXT"Low" On Current	Same as $I_{DD1}.$ $V_{EXT}=0.4V,$		13.25		mA
$V_{CEH}$	CE"High" Voltage	$V_{out}=V_{ce}=\text{set } V_{out} \times 0.95$	0.70			V
$V_{CEL}$	CE"Low" Voltage	$V_{out}=V_{ce}=\text{set } V_{out} \times 0.95$			0.20	V
$I_{CEH}$	CE"High" Current	$V_{out}=6.0V, V_{ce}=6.0V$			0.25	$\mu A$
$I_{CEL}$	CE"low" Current	$V_{out}=6.0V, V_{ce}=0.0V$			-0.25	$\mu A$
$F_{osc}$	Oscillation Frequency	$V_{out}=\text{set } V_{out} \times 0.95$		100		kHz
Maxdty	Duty Ratio	on( $V_{LX}$ "L" )side	80	87	92	%
EFFI	Efficiency			85		%
Tss	Slow-Start Time		5	15	25	mS

Measuring conditions: Unless otherwise specified,  $V_{IN}=V_{out} \times 0.6,$   $V_{SS}=0V,$   $I_{OUT}=10mA,$   $T_{opt}=25^{\circ}C.$

Note: 1、Diode use Schottky diode such as IN5817 or IN5819 (forward voltage drop:0.2V)

2、Inductor:  $47 \mu H$  ( $r < 0.5 \Omega$ )

3、Capacitor: Tantalum type  $47 \mu F$

## Operation

ME2101 step-up DC/DC converter charges energy in the inductor when Lx Transistor is on, and discharges the energy with the addition of the energy from input power source thereto, so that a higher output voltage than the input voltage is obtained. Following is the operation diagram.

### Switching DC/DC Step\_up Converter operating process

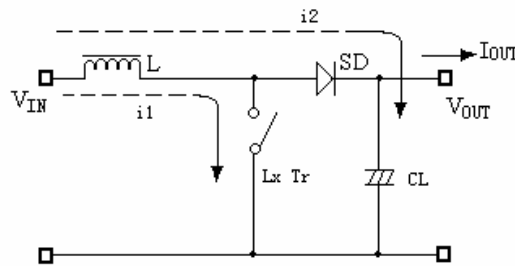

## Selection of Peripheral Components and Application Notes

Peripheral components should be selected carefully because they are greatly affect the performances of ME2101:

- Use capacitor with a capacity of 10  $\mu$ F or more ( too small capacity will lead to high output ripple), and with good frequency characteristics ( it is better to use Tantalum type). Besides, it is recommended the use of a capacitor with an allowable voltage which is at least three times the output set voltage. This is because there may be the case where a spike-shaped high voltage is generated by the inductor when Lx transistor is turned OFF.
- Choose such an inductor that has sufficiently small d.c. resistance and large allowable current, and hardly reaches magnetic saturation. When the inductance value of the inductor is small, there may be the case where  $I_{LX}$  exceeds the absolute maximum ratings at the maximum load.
- Use a diode of a Schottky type with high switching speed.

### Notes:

- Set external components as close as possible to the IC and minimize the connection between the components and the IC. In particular, when an external component is connected to  $V_{OUT}$  Pin, make minimum connection with the capacitor. A 0.1 $\mu$ F ceramic capacitor is suggested to be parallelly connected to  $V_{OUT}$  Pin and  $V_{SS}$  Pin.
- Make  $V_{SS}$  pin sufficient grounding, otherwise, the zero level within IC will varied with the switching current. This may result in unstable operation of IC.

## Typical Applications

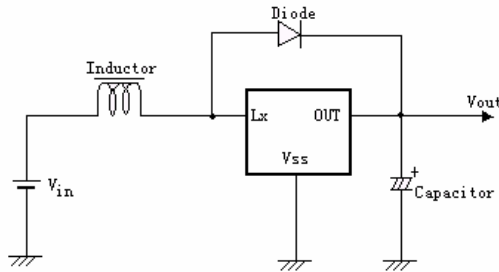

For use Build\_in Transistor

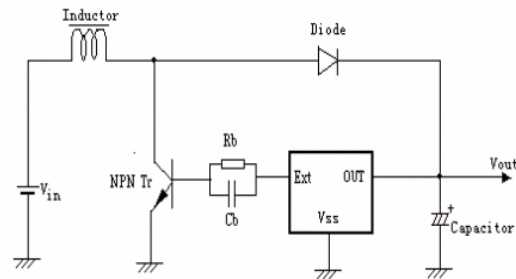

For use External Transistor

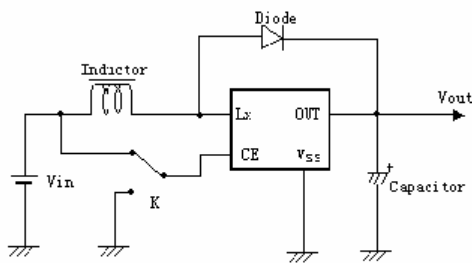

For use Chip Enable(CE)

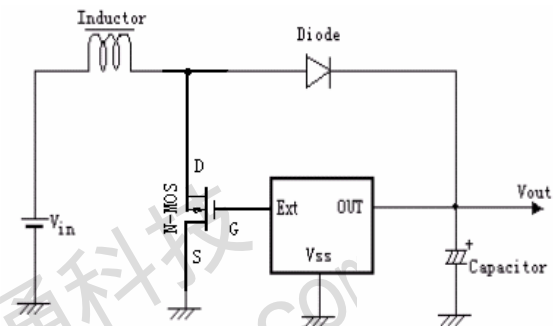

For use external transistor(N\_MOS)

Components: Inductor: 47uH(Sumida )

Diode: IN5817、IN5819

Capacitor: 47uF/16V(Tantalume type)

Transistor: 2SD1628G、2SD3279

NMOS: AAT9460、XP151、XP161

Base Resistor(Rb): 1KΩ

Base Capacitor(Cb): 2200pF

$R_{FB}$  :Set up so that  $R_{FB1}/R_{FB2}=V_{out}-1$  ( $V_{out}$ =set-up output voltage),

Please use with  $R_{FB1}+R_{FB2} \leq 2M\Omega$  ;

$C_{FB}$ :Set up that  $F_{zfb}=1/(2 \times \pi \times C_{FB} \times R_{FB1})$  is within the Adjustments necessary in respect of L,CL.



## Type Characteristics

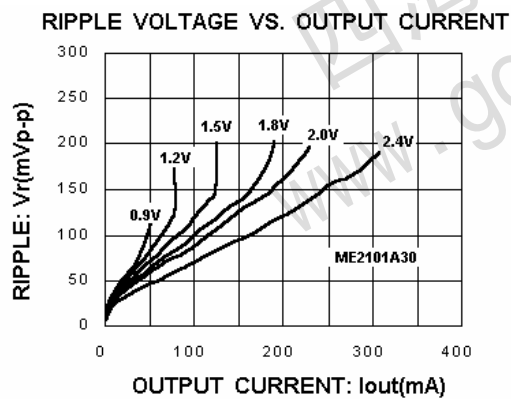
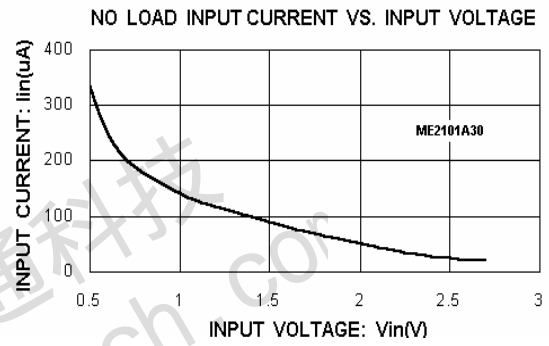
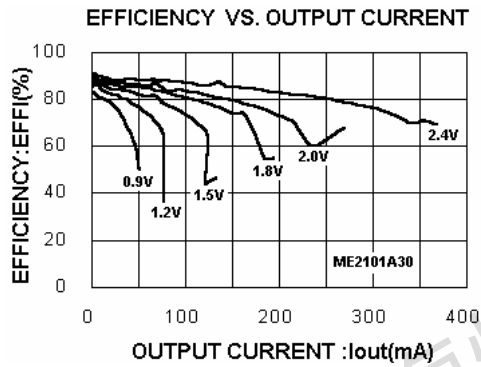
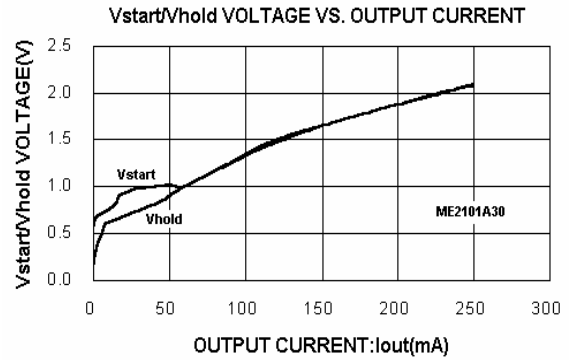
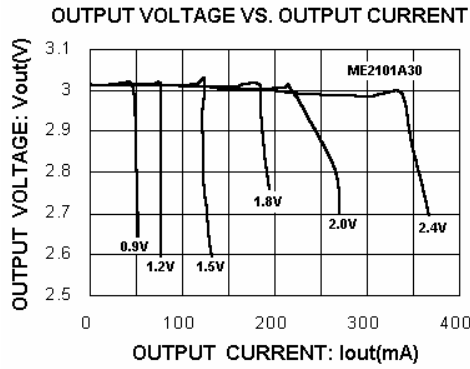

### Package Diomensions

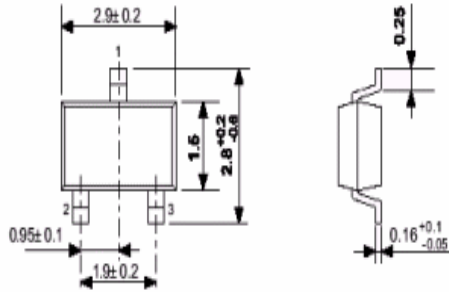

SOT23-3

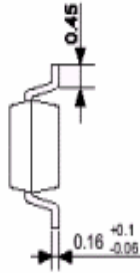
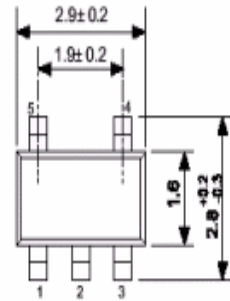

SOT23-5

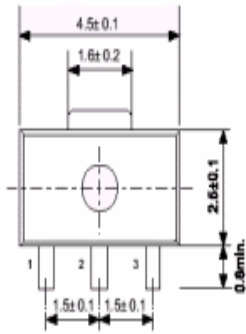
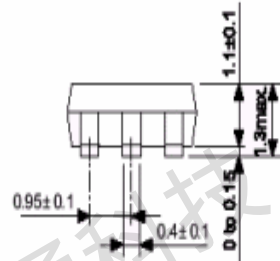
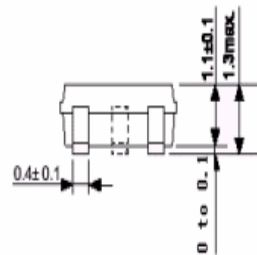

SOT89-3

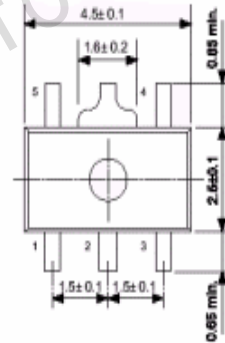

SOT89-5

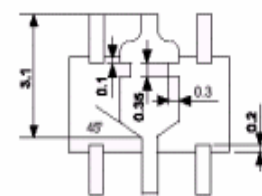
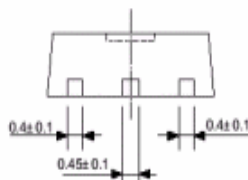
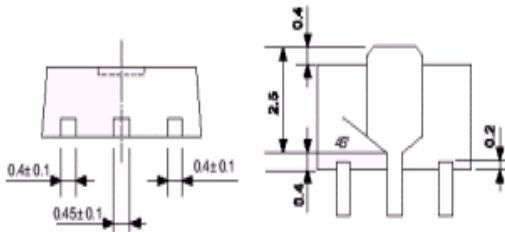



- **The information described herein is subject to change without notice.**
- **Nanjing Micro One Electronics Inc is not responsible for any problems caused by circuits or diagrams described herein whose related industrial properties, patents, or other rights belong to third parties. The application circuit examples explain typical applications of the products, and do not guarantee the success of any specific mass-production design.**
- **Use of the information described herein for other purposes and/or reproduction or copying without the express permission of Nanjing Micro One Electronics Inc is strictly prohibited.**
- **The products described herein cannot be used as part of any device or equipment affecting the human body, such as exercise equipment, medical equipment, security systems, gas equipment, or any apparatus installed in airplanes and other vehicles, without prior written permission of Nanjing Micro One Electronics Inc.**
- **Although Nanjing Micro One Electronics Inc exerts the greatest possible effort to ensure high quality and reliability, the failure or malfunction of semiconductor products may occur. The user of these products should therefore give thorough consideration to safety design, including redundancy, fire-prevention measures, and malfunction prevention, to prevent any accidents, fires, or community damage that may ensue.**