

**Rectifier diodes
ultrafast, rugged**

BYV72EW series

GENERAL DESCRIPTION

Glass passivated high efficiency rugged dual rectifier diodes in a plastic envelope, featuring low forward voltage drop, ultra-fast recovery times and soft recovery characteristic. These devices can withstand reverse voltage transients and have guaranteed reverse surge and ESD capability. They are intended for use in switched mode power supplies and high frequency circuits in general where low conduction and switching losses are essential.

QUICK REFERENCE DATA

SYMBOL	PARAMETER	MAX.	MAX.	MAX.	UNIT
V_{RRM}	BYV72EW- Repetitive peak reverse voltage	100 100	150 150	200 200	V
V_F	Forward voltage	0.90	0.90	0.90	V
$I_{O(AV)}$	Output current (both diodes conducting)	30	30	30	A
t_{rr}	Reverse recovery time	28	28	28	ns
I_{RRM}	Repetitive peak reverse current per diode	0.2	0.2	0.2	A

PINNING - SOT429 (TO247)

PIN	DESCRIPTION
1	Anode 1 (a)
2	Cathode (k)
3	Anode 2 (a)
mounting base	Cathode (k)

PIN CONFIGURATION

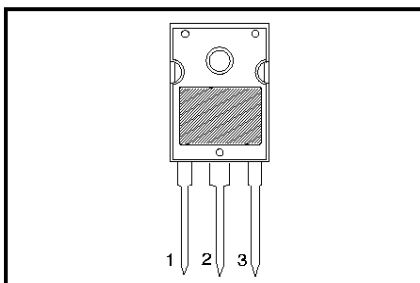

SYMBOL

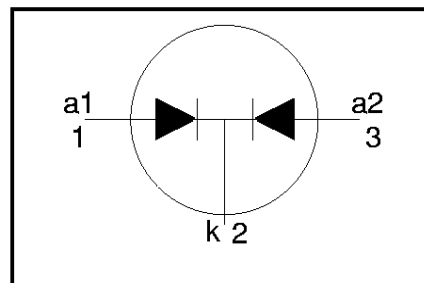

LIMITING VALUES

Limiting values in accordance with the Absolute Maximum System (IEC 134).

SYMBOL	PARAMETER	CONDITIONS	MIN.	MAX.			UNIT
				-100	-150	-200	
V_{RRM}	Repetitive peak reverse voltage		-	100	150	200	V
V_{RWM}	Crest working reverse voltage		-	100	150	200	V
V_R	Continuous reverse voltage ¹		-	100	150	200	V
$I_{O(AV)}$	Output current (both diodes conducting) ²	square wave $\delta = 0.5$; $T_{mb} \leq 104^\circ\text{C}$ sinusoidal; $a = 1.57$; $T_{mb} \leq 107^\circ\text{C}$	-	30			A
$I_{O(RMS)}$	RMS forward current		-	43			A
I_{FRM}	Repetitive peak forward current per diode	$t = 25 \mu\text{s}$; $\delta = 0.5$; $T_{mb} \leq 104^\circ\text{C}$	-	30			A
I_{FSM}	Non-repetitive peak forward current per diode	$t = 10 \text{ ms}$ $t = 8.3 \text{ ms}$ sinusoidal; with reapplied	-	150			A
I_{FSM}^2	I^2t for fusing	$V_{RWM(max)}$ $t = 10 \text{ ms}$	-	112			A ² s
I_{RRM}	Repetitive peak reverse current per diode	$t_p = 2 \mu\text{s}$; $\delta = 0.001$	-	0.2			A
I_{RSM}	Non-repetitive peak reverse current per diode	$t_p = 100 \mu\text{s}$	-	0.2			A
T_{sig}	Storage temperature		-40	150			$^\circ\text{C}$
T_j	Operating junction temperature		-	150			$^\circ\text{C}$

¹ $T_{mb} \leq 144^\circ\text{C}$ for thermal stability.

² Neglecting switching and reverse current losses.

**Rectifier diodes
ultrafast, rugged**
BYV72EW series
ESD LIMITING VALUE

SYMBOL	PARAMETER	CONDITIONS	MIN.	MAX.	UNIT
V_C	Electrostatic discharge capacitor voltage	Human body model; $C = 250 \text{ pF}$; $R = 1.5 \text{ k}\Omega$	-	8	kV

THERMAL RESISTANCES

SYMBOL	PARAMETER	CONDITIONS	MIN.	TYP.	MAX.	UNIT
$R_{th(j-mb)}$	Thermal resistance junction to mounting base	per diode both diodes conducting	-	-	2.4	K/W
$R_{th(j-a)}$	Thermal resistance junction to ambient	in free air	-	45	-	K/W

STATIC CHARACTERISTICS
 $T_j = 25 \text{ }^\circ\text{C}$ unless otherwise stated

SYMBOL	PARAMETER	CONDITIONS	MIN.	TYP.	MAX.	UNIT
V_F	Forward voltage (per diode)	$I_F = 15 \text{ A}$; $T_j = 150 \text{ }^\circ\text{C}$	-	0.83	0.90	V
		$I_F = 15 \text{ A}$	-	0.95	1.05	V
		$I_F = 30 \text{ A}$	-	1.00	1.20	V
I_R	Reverse current (per diode)	$V_R = V_{RWM}$; $T_j = 100 \text{ }^\circ\text{C}$	-	0.5	1	mA
		$V_R = V_{RWM}$	-	10	100	μA

DYNAMIC CHARACTERISTICS
 $T_j = 25 \text{ }^\circ\text{C}$ unless otherwise stated

SYMBOL	PARAMETER	CONDITIONS	MIN.	TYP.	MAX.	UNIT
Q_s	Reverse recovery charge (per diode)	$I_F = 2 \text{ A}$; $V_R \geq 30 \text{ V}$; $-di_F/dt = 20 \text{ A}/\mu\text{s}$	-	6	15	nC
t_{rr1}	Reverse recovery time (per diode)	$I_F = 1 \text{ A}$; $V_R \geq 30 \text{ V}$; $-di_F/dt = 100 \text{ A}/\mu\text{s}$	-	20	28	ns
t_{rr2}	Reverse recovery time (per diode)	$I_F = 0.5 \text{ A}$ to $I_R = 1 \text{ A}$; $I_{rec} = 0.25 \text{ A}$	-	13	22	ns
V_{tr}	Forward recovery voltage (per diode)	$I_F = 1 \text{ A}$; $di_F/dt = 10 \text{ A}/\mu\text{s}$	-	1	-	V

Rectifier diodes
ultrafast, rugged

BYV72EW series

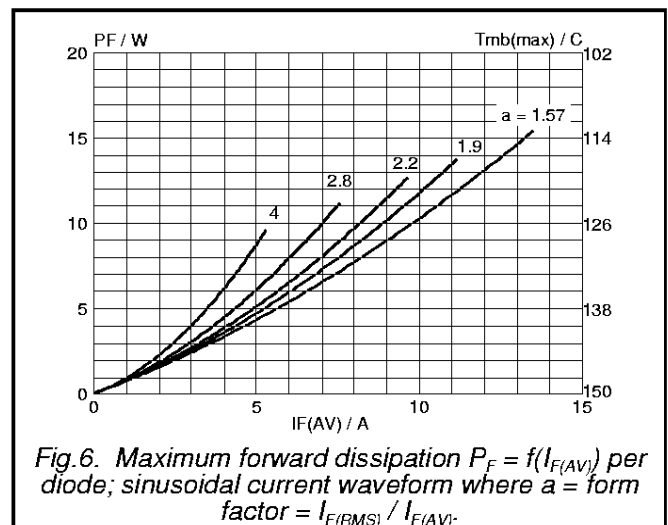
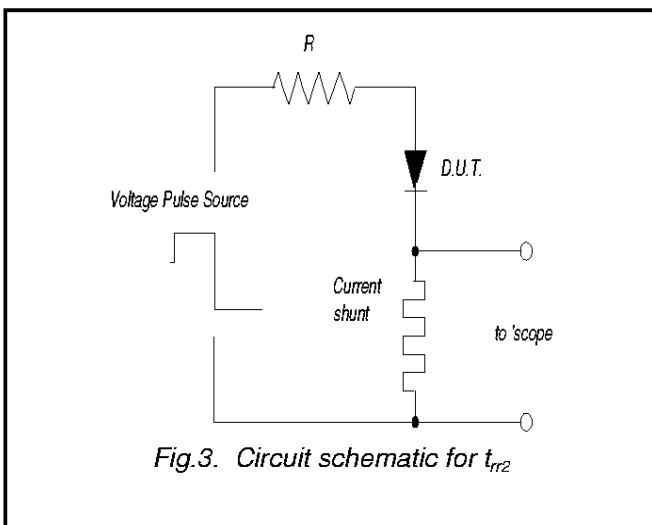
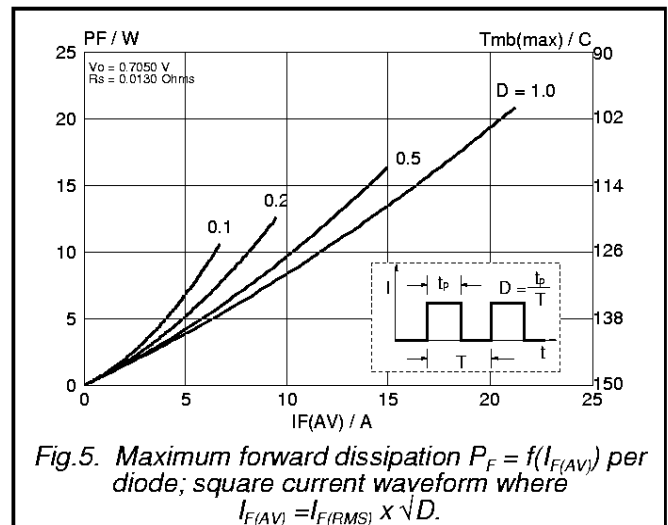
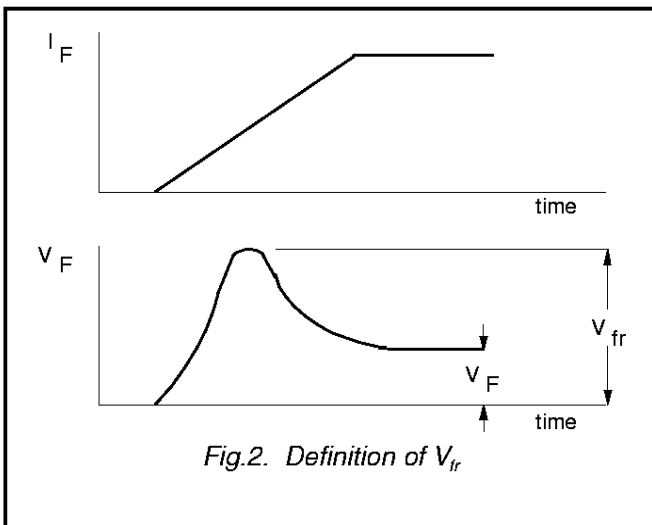
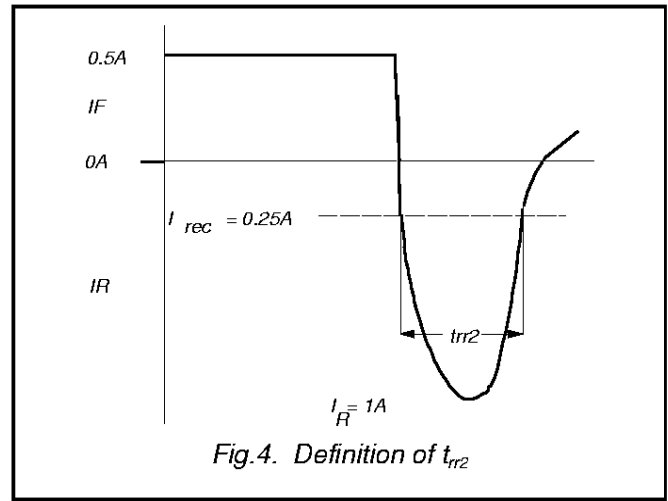
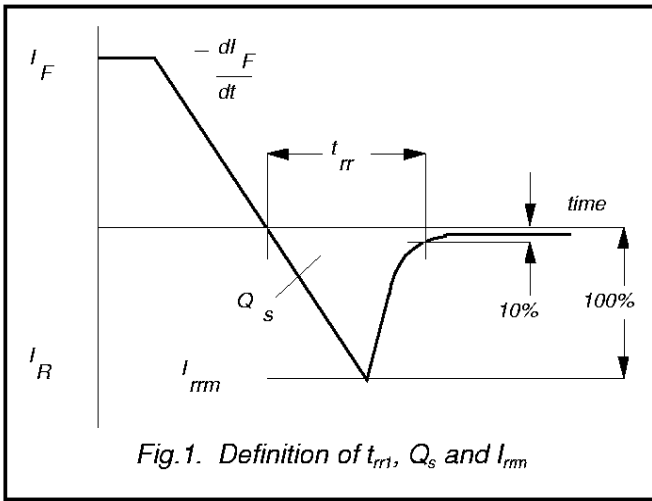

Rectifier diodes
ultrafast, rugged

BYV72EW series

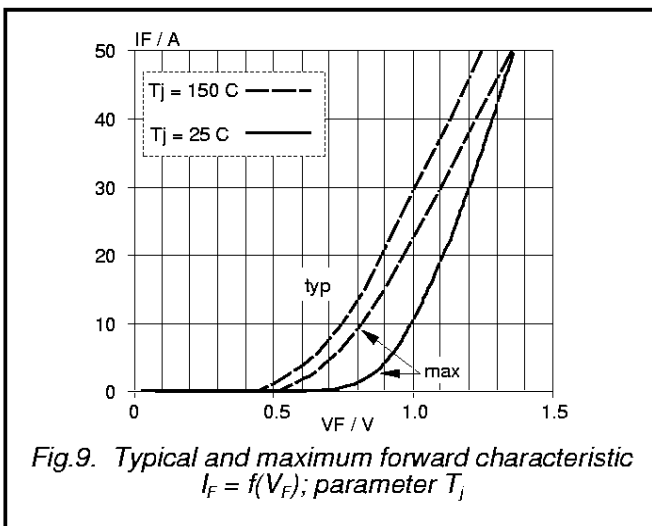
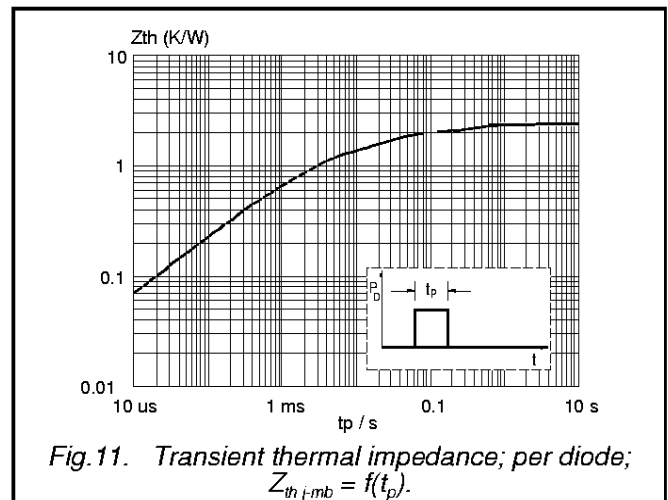
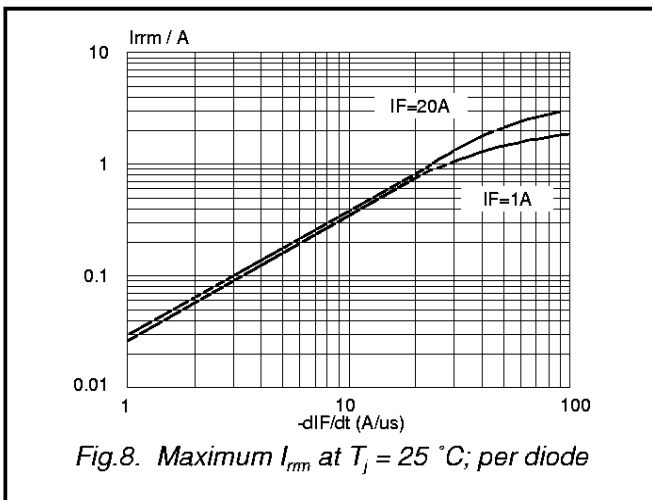
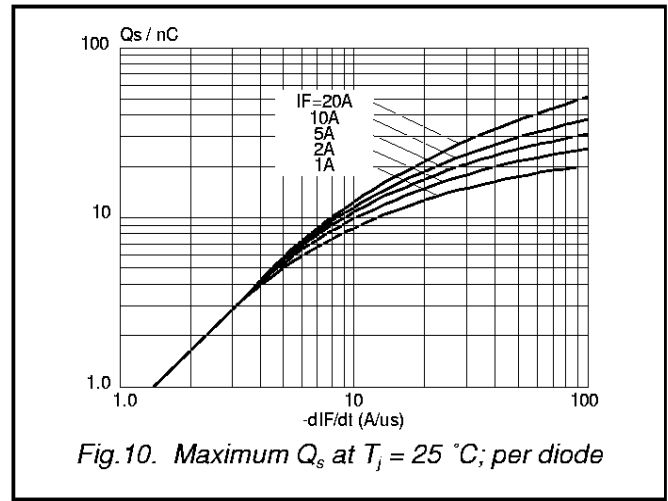
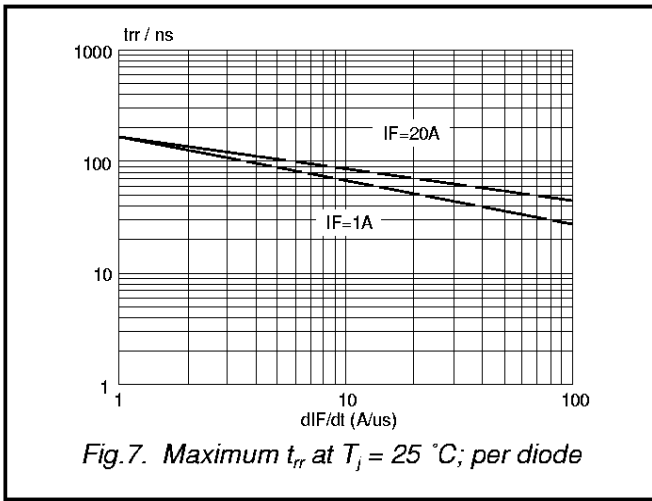

Rectifier diodes
ultrafast, rugged

BYV72EW series

MECHANICAL DATA

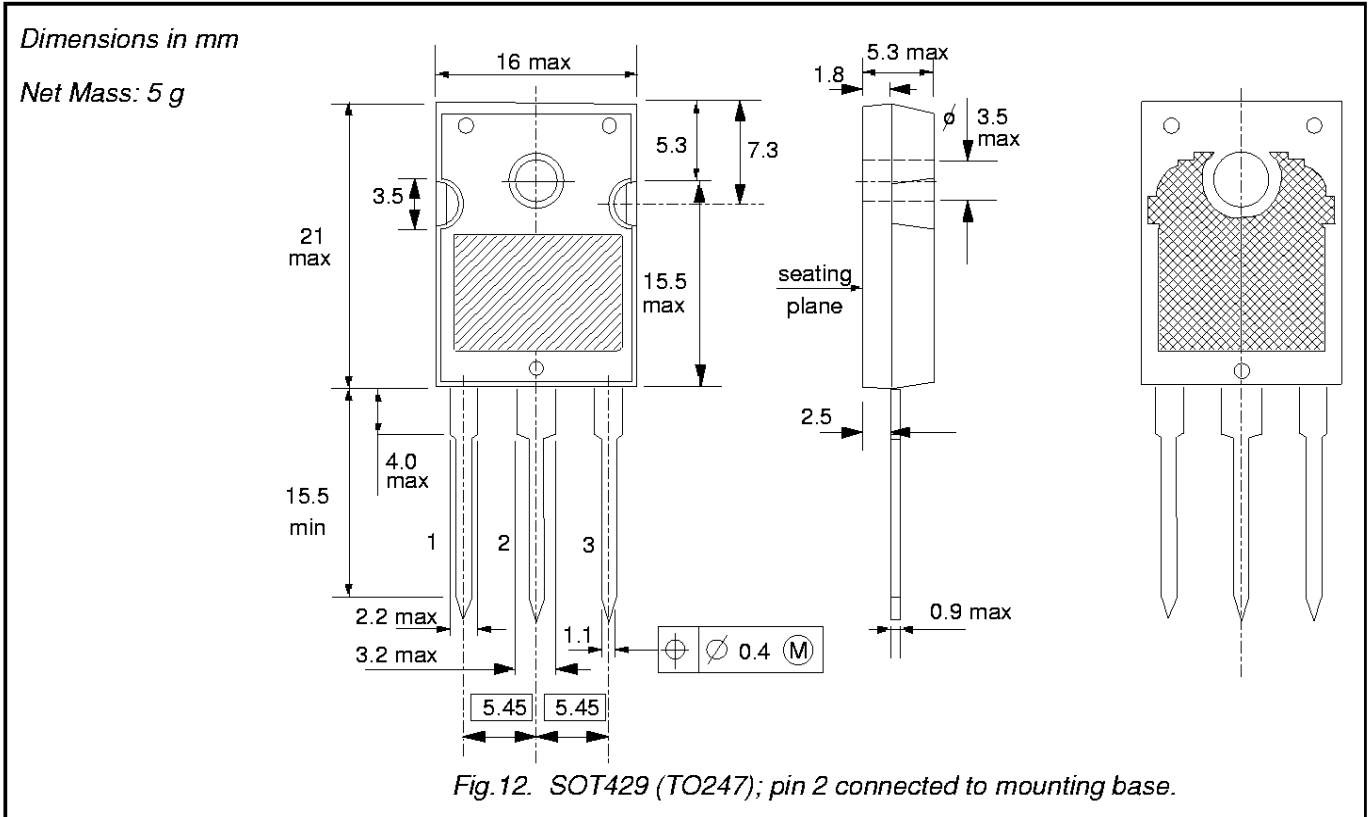

Notes

- 1. Refer to mounting instructions for SOT429 envelope.
- 2. Epoxy meets UL94 V0 at 1/8".

**Rectifier diodes
ultrafast, rugged**

BYV72EW series**DEFINITIONS**

Data sheet status	
Objective specification	This data sheet contains target or goal specifications for product development.
Preliminary specification	This data sheet contains preliminary data; supplementary data may be published later.
Product specification	This data sheet contains final product specifications.
Limiting values	
Limiting values are given in accordance with the Absolute Maximum Rating System (IEC 134). Stress above one or more of the limiting values may cause permanent damage to the device. These are stress ratings only and operation of the device at these or at any other conditions above those given in the Characteristics sections of this specification is not implied. Exposure to limiting values for extended periods may affect device reliability.	
Application information	
Where application information is given, it is advisory and does not form part of the specification.	
© Philips Electronics N.V. 1997	
All rights are reserved. Reproduction in whole or in part is prohibited without the prior written consent of the copyright owner.	
The information presented in this document does not form part of any quotation or contract, it is believed to be accurate and reliable and may be changed without notice. No liability will be accepted by the publisher for any consequence of its use. Publication thereof does not convey nor imply any license under patent or other industrial or intellectual property rights.	

LIFE SUPPORT APPLICATIONS

These products are not designed for use in life support appliances, devices or systems where malfunction of these products can be reasonably expected to result in personal injury. Philips customers using or selling these products for use in such applications do so at their own risk and agree to fully indemnify Philips for any damages resulting from such improper use or sale.