

# PART No. 1487B2P

for more information visit

[www.hammfg.com](http://www.hammfg.com)

Data subject to change without notice

Isometric drawing Not to Scale

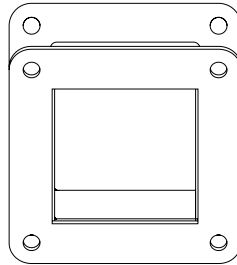

**TOP VIEW**

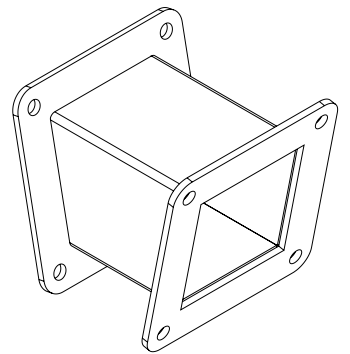

**ISOMETRIC VIEW**

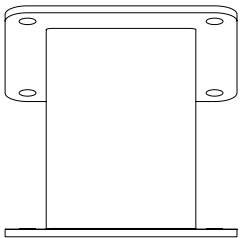

**BACK VIEW**

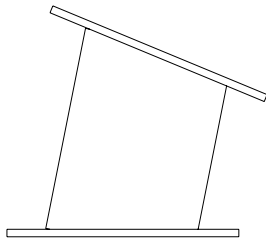

**SIDE VIEW**

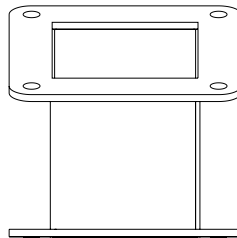

**FRONT VIEW**

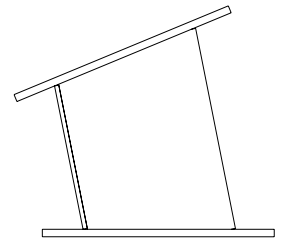

**SIDE VIEW**

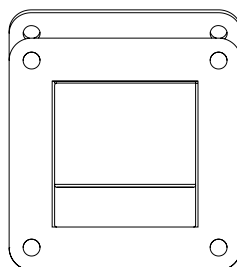

**BOTTOM VIEW**