



P6KE

TVS

TRANSIENT VOLTAGE SUPPRESSORS

DESCRIPTION

The UTC **P6KE** is Transient Voltage Suppressors. it uses UTC's advanced technology to provide customers with low leakage current, ultra-low response time and perfect clamping capability, etc

FEATURES

- * Low leakage current
- * Ultra-low response time
- * Perfect clamping capability

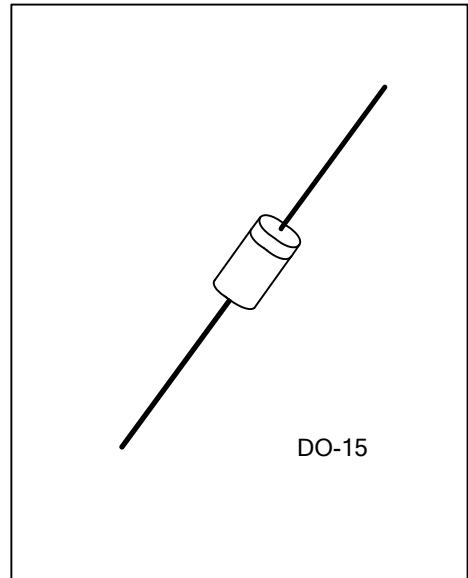

ORDERING INFORMATION

Ordering Number		Package	Pin Assignment		Packing
Lead Free	Halogen Free		1	2	
P6KEXXXXXL-Z15-R	P6KEXXXXXG-Z15-R	DO-15	K	A	Tape Reel

<p>P6KEXXXXXL-Z15-R</p>	<p>(1) R: Tape Reel (2) Z15: DO-15 (3) L: Lead Free, G: Halogen Free (4) Blank: 10% uni-directional, A: 5% uni-directional, C : 10% Bi-directional, CA: 5% Bi-directional (5) xxx: refer to ELECTRICAL CHARACTERISTICS</p>
-------------------------	--

MARKING

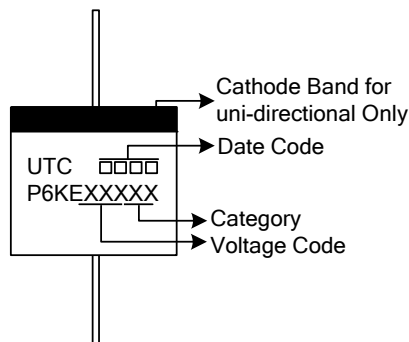

■ ABSOLUTE MAXIMUM RATINGS (T_A=25°C, unless otherwise noted)

PARAMETER	SYMBOL	RATINGS	UNIT
Peak Power Dissipation with a 10/1000µs Waveform (Note 2)	P _{PP}	600	W
Peak Pulse Current with a 10/1000µs Waveform (Note 2)	I _{RSM}	See Next Table	A
Power Dissipation on Infinite Heatsink at T _L =75 °C	P _D	5.0	W
Peak Forward Surge Current (Note 3)	I _{FSM}	100	A
Maximum Instantaneous Forward Voltage at 50A for Unidirectional Only (Note 4)	V _F	3.5/5.0	V
Operating Junction Temperature	T _J	-55~+150	°C
Storage Temperature	T _{STG}	-55~+150	°C

Notes: 1. Absolute maximum ratings are those values beyond which the device could be permanently damaged.

Absolute maximum ratings are stress ratings only and functional device operation is not implied.

2. Non-repetitive current pulse and derated above T_A=25°C

3. Measured on 8.3ms single half sine-wave or equivalent square wave, duty cycle=4 pulses per minute maximum

4. V_F<3.5V for devices of V_{BR}<200V and V_F<5.0V for devices of V_{BR}>201V

■ ELECTRICAL CHARACTERISTICS (T_A=25°C, unless otherwise noted)

PART NUMBER (UNI)	PART NUMBER (BI)	BREAKDOWN VOLTAGE V _{BR} @ I _T			MAXIMUM REVERSE LEAKAGE I _R @ V _{RWM} (µA)	WORKING PEAK REVERSE VOLTAGE V _{RWM} (V)	MAXIMUM REVERSE SURGE CURRENT I _{RSM} (A)	MAXIMUM CLAMPING VOLTAGE V _C @ I _{RSM} (V)
		MIN (V)	TYP (V)	MAX (mA)				
P6KE6.8	P6KE6.8C	6.12	7.48	10	1000	5.5	55.56	10.8
P6KE6.8A	P6KE6.8CA	6.46	7.14	10	1000	5.8	57.14	10.5
P6KE7.5	P6KE7.5C	6.75	8.25	10	500	6.1	51.28	11.7
P6KE7.5A	P6KE7.5CA	7.13	7.88	10	500	6.4	53.10	11.3
P6KE8.2	P6KE8.2C	7.38	9.02	10	200	6.6	48.00	12.5
P6KE8.2A	P6KE8.2CA	7.79	8.61	10	200	7.0	49.59	12.1
P6KE9.1	P6KE9.1C	8.19	10.01	1	50	7.4	43.48	13.8
P6KE9.1A	P6KE9.1CA	8.65	9.56	1	50	7.8	44.78	13.4
P6KE10	P6KE10C	9.00	11.00	1	10	8.1	40.00	15.0
P6KE10A	P6KE10CA	9.50	10.50	1	10	8.6	41.38	14.5
P6KE11	P6KE11C	9.90	12.10	1	5	8.9	37.04	16.2
P6KE11A	P6KE11CA	10.45	11.55	1	5	9.4	38.46	15.6
P6KE12	P6KE12C	10.80	13.20	1	5	9.7	34.68	17.3
P6KE12A	P6KE12CA	11.40	12.60	1	5	10.2	35.93	16.7
P6KE13	P6KE13C	11.70	14.30	1	1	10.5	31.58	19.0
P6KE13A	P6KE13CA	12.35	13.65	1	1	11.1	32.97	18.2
P6KE15	P6KE15C	13.50	16.50	1	1	12.1	27.27	22.0
P6KE15A	P6KE15CA	14.25	15.75	1	1	12.8	28.30	21.2
P6KE16	P6KE16C	14.40	17.60	1	1	12.9	25.53	23.5
P6KE16A	P6KE16CA	15.20	16.80	1	1	13.6	26.67	22.5
P6KE18	P6KE18C	16.20	19.80	1	1	14.5	22.64	26.5
P6KE18A	P6KE18CA	17.10	18.90	1	1	15.3	23.81	25.2
P6KE20	P6KE20C	18.00	22.00	1	1	16.2	20.62	29.1
P6KE20A	P6KE20CA	19.00	21.00	1	1	17.1	21.66	27.7
P6KE22	P6KE22C	19.80	24.20	1	1	17.8	18.81	31.9
P6KE22A	P6KE22CA	20.90	23.10	1	1	18.8	19.61	30.6
P6KE24	P6KE24C	21.60	26.40	1	1	19.4	17.29	34.7
P6KE24A	P6KE24CA	22.80	25.20	1	1	20.5	18.07	33.2

■ ELECTRICAL CHARACTERISTICS(Cont.)

PART NUMBER (UNI)	PART NUMBER (BI)	BREAKDOWN VOLTAGE V_{BR} @ I_T			MAXIMUM REVERSE LEAKAGE I_R @ V_{RWM} (μA)	WORKING PEAK REVERSE VOLTAGE V_{RWM} (V)	MAXIMUM REVERSE SURGE CURRENT V_{RSM} (A)	MAXIMUM CLAMPING VOLTAGE V_C @ I_{RSM} (V)
		MIN (V)	TYP (V)	MAX (mA)				
P6KE27	P6KE27C	24.30	29.70	1	1	21.8	15.35	39.1
P6KE27A	P6KE27CA	25.65	28.35	1	1	23.1	16.00	37.5
P6KE30	P6KE30C	27.00	33.00	1	1	24.3	13.79	43.5
P6KE30A	P6KE30CA	28.50	31.50	1	1	25.6	14.49	41.4
P6KE33	P6KE33C	29.70	36.30	1	1	26.8	12.58	47.7
P6KE33A	P6KE33CA	31.35	34.65	1	1	28.2	13.13	45.7
P6KE36	P6KE36C	32.40	39.60	1	1	29.1	11.54	52.0
P6KE36A	P6KE36CA	34.20	37.80	1	1	30.8	12.02	49.9
P6KE39	P6KE39C	35.10	42.90	1	1	31.6	10.64	56.4
P6KE39A	P6KE39CA	37.05	40.95	1	1	33.3	11.13	53.9
P6KE43	P6KE43C	38.70	47.30	1	1	34.8	9.69	61.9
P6KE43A	P6KE43CA	40.85	45.15	1	1	36.8	10.12	59.3
P6KE47	P6KE47C	42.30	51.70	1	1	38.1	8.85	67.8
P6KE47A	P6KE47CA	44.65	49.35	1	1	40.2	9.26	64.8
P6KE51	P6KE51C	45.90	56.10	1	1	41.3	8.16	73.5
P6KE51A	P6KE51CA	48.45	53.55	1	1	43.6	8.56	70.1
P6KE56	P6KE56C	50.40	61.60	1	1	45.4	7.45	80.5
P6KE56A	P6KE56CA	53.20	58.80	1	1	47.8	7.79	77.0
P6KE62	P6KE62C	55.80	68.20	1	1	50.2	6.74	89.0
P6KE62A	P6KE62CA	58.90	65.10	1	1	53.0	7.06	85.0
P6KE68	P6KE68C	61.20	74.80	1	1	55.1	6.12	98.0
P6KE68A	P6KE68CA	64.60	71.40	1	1	58.1	6.52	92.0
P6KE75	P6KE75C	67.50	82.50	1	1	60.7	5.56	108.0
P6KE75A	P6KE75CA	71.25	78.75	1	1	64.1	5.83	103.0
P6KE82	P6KE82C	73.80	90.20	1	1	66.4	5.08	118.0
P6KE82A	P6KE82CA	77.90	86.10	1	1	70.1	5.31	113.0
P6KE91	P6KE91C	81.90	100.10	1	1	73.7	4.58	131.0
P6KE91A	P6KE91CA	86.45	95.55	1	1	77.8	4.80	125.0
P6KE100	P6KE100C	90.00	110.00	1	1	81.0	4.17	144.0
P6KE100A	P6KE100CA	95.00	105.00	1	1	85.5	4.38	137.0
P6KE110	P6KE110C	99.00	121.00	1	1	89.2	3.80	158.0
P6KE110A	P6KE110CA	104.50	115.50	1	1	94.0	3.95	152.0
P6KE120	P6KE120C	108.00	132.00	1	1	97.2	3.47	173.0
P6KE120A	P6KE120CA	114.00	126.00	1	1	102.0	3.64	165.0
P6KE130	P6KE130C	117.00	143.00	1	1	105.0	3.21	187.0
P6KE130A	P6KE130CA	123.50	136.50	1	1	111.0	3.35	179.0
P6KE150	P6KE150C	135.00	165.00	1	1	121.0	2.79	215.0
P6KE150A	P6KE150CA	142.50	157.50	1	1	128.0	2.90	207.0
P6KE160	P6KE160C	144.00	176.00	1	1	130.0	2.61	230.0
P6KE160A	P6KE160CA	152.00	168.00	1	1	136.0	2.74	219.0
P6KE170	P6KE170C	153.00	187.00	1	1	138.0	2.46	244.0
P6KE170A	P6KE170CA	161.50	178.50	1	1	145.0	2.56	234.0
P6KE180	P6KE180C	162.00	198.00	1	1	146.0	2.33	258.0
P6KE180A	P6KE180CA	171.00	189.00	1	1	154.0	2.44	246.0
P6KE200	P6KE200C	180.00	220.00	1	1	162.0	2.09	287.0
P6KE200A	P6KE200CA	190.00	210.00	1	1	171.0	2.19	274.0

■ ELECTRICAL CHARACTERISTICS(Cont.)

PART NUMBER (UNI)	PART NUMBER (BI)	BREAKDOWN VOLTAGE V_{BR} @ I_T			MAXIMUM REVERSE LEAKAGE I_R @ V_{RWM} (μ A)	WORKING PEAK REVERSE VOLTAGE V_{RWM} (V)	MAXIMUM REVERSE SURGE CURRENT V_{RSM} (A)	MAXIMUM CLAMPING VOLTAGE V_C @ I_{RSM} (V)
		MIN (V)	TYP (V)	MAX (mA)				
P6KE220	P6KE220C	198.00	242.00	1	1	175.0	1.74	344.0
P6KE220A	P6KE220CA	209.00	231.00	1	1	185.0	1.83	328.0
P6KE250	P6KE250C	225.00	275.00	1	1	202.0	1.67	360.0
P6KE250A	P6KE250CA	237.50	262.50	1	1	214.0	1.74	344.0
P6KE300	P6KE300C	270.00	330.00	1	1	243.0	1.40	430.0
P6KE300A	P6KE300CA	285.00	315.00	1	1	256.0	1.45	414.0
P6KE350	P6KE350C	315.00	385.00	1	1	284.2	1.19	504.0
P6KE350A	P6KE350CA	332.50	367.50	1	1	299.3	1.24	482.0
P6KE380	P6KE380C	342.00	418.00	1	1	308.6	1.10	547.2
P6KE380A	P6KE380CA	361.00	399.00	1	1	324.9	1.14	524.4
P6KE400	P6KE400C	360.00	440.00	1	1	324.8	1.05	574.0
P6KE400A	P6KE400CA	380.00	420.00	1	1	342.0	1.09	548.0
P6KE440	P6KE440C	396.00	484.00	1	1	357.3	0.95	633.6
P6KE440A	P6KE440CA	418.00	462.00	1	1	376.2	0.99	607.2
P6KE500	P6KE500C	450.00	550.00	1	1	406.0	0.83	720.0
P6KE500A	P6KE500CA	475.00	525.00	1	1	427.5	0.87	690.0
P6KE520	P6KE520C	468.00	572.00	1	1	422.2	0.80	748.8
P6KE520A	P6KE520CA	494.00	546.00	1	1	444.6	0.84	717.6
P6KE550	P6KE550C	495.00	605.00	1	1	446.6	0.76	792.0
P6KE550A	P6KE550CA	522.50	577.50	1	1	470.3	0.79	759.0
P6KE600	P6KE600C	540.00	660.00	1	1	487.2	0.69	864.0
P6KE600A	P6KE600CA	570.00	630.00	1	1	513.0	0.72	828.0

■ TYPICAL CHARACTERISTICS ($T_A=25^\circ\text{C}$, unless otherwise noted)

Fig 1. Pulse Derating Curve

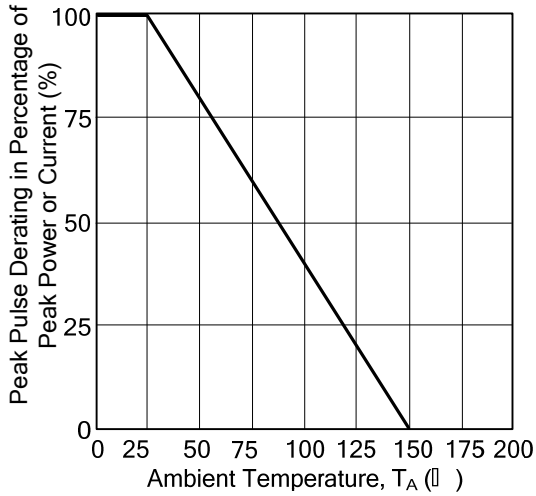

Fig 2. Maximum Non-Repetitive Surge Current

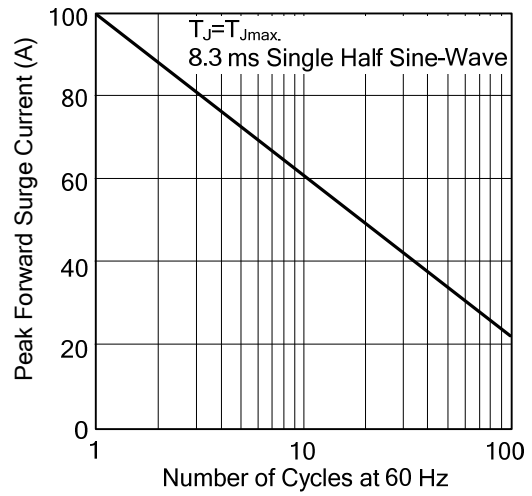

Fig 3. Steady State Power Derating Curve

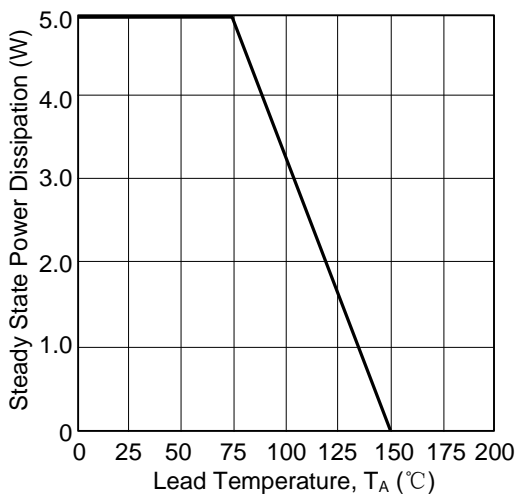

Fig 4. Peak Pulse Power Rating Curve

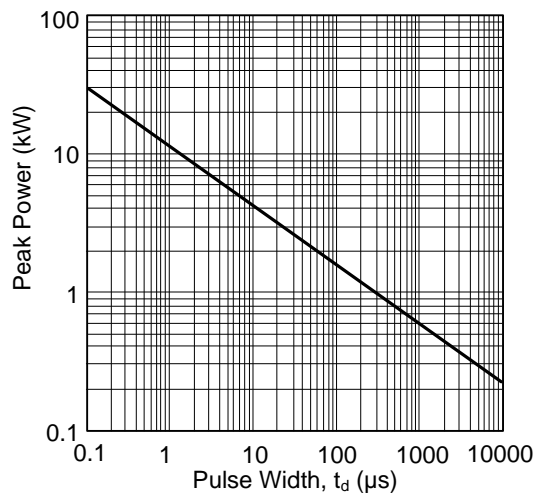

Fig 5. Pulse Waveform

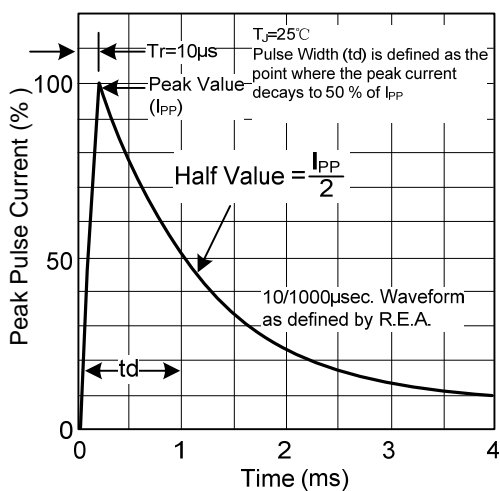
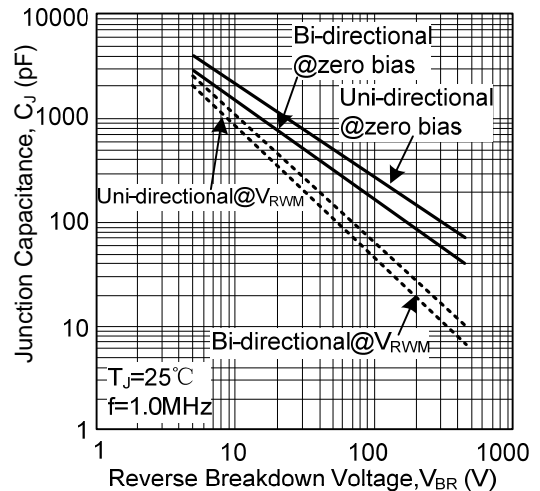

Fig 6. Typical Junction Capacitance



UTC assumes no responsibility for equipment failures that result from using products at values that exceed, even momentarily, rated values (such as maximum ratings, operating condition ranges, or other parameters) listed in products specifications of any and all UTC products described or contained herein. UTC products are not designed for use in life support appliances, devices or systems where malfunction of these products can be reasonably expected to result in personal injury. Reproduction in whole or in part is prohibited without the prior written consent of the copyright owner. The information presented in this document does not form part of any quotation or contract, is believed to be accurate and reliable and may be changed without notice.