



# RF Power LDMOS Transistor

## N-Channel Enhancement-Mode Lateral MOSFET

This 80 watt RF power LDMOS transistor is designed for cellular base station applications covering the frequency range of 720 to 960 MHz.

- Typical Single-Carrier W-CDMA Performance:  $V_{DD} = 28$  Volts,  $I_{DQ} = 1400$  mA,  $P_{out} = 80$  Watts Avg., Input Signal PAR = 7.5 dB @ 0.01% Probability on CCDF.

Frequency	$G_{ps}$ (dB)	$\eta_D$ (%)	Output PAR (dB)	ACPR (dBc)	IRL (dB)
920 MHz	20.0	35.9	6.3	-38.0	-14
940 MHz	20.1	36.2	6.2	-37.6	-18
960 MHz	20.0	36.1	6.1	-37.5	-17

### Features

- Greater Negative Gate-Source Voltage Range for Improved Class C Operation
- Designed for Digital Predistortion Error Correction Systems
- Optimized for Doherty Applications
- In Tape and Reel. R3 Suffix = 250 Units, 32 mm Tape Width, 13 inch Reel.

**AFT09S282NR3**

**720-960 MHz, 80 W AVG., 28 V**

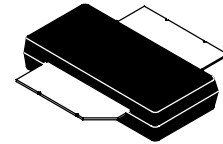

**OM-780-2  
 PLASTIC**

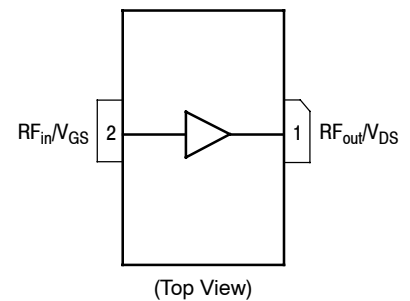

**Figure 1. Pin Connections**

**Table 1. Maximum Ratings**

Rating	Symbol	Value	Unit
Drain-Source Voltage	$V_{DSS}$	-0.5, +70	Vdc
Gate-Source Voltage	$V_{GS}$	-6.0, +10	Vdc
Operating Voltage	$V_{DD}$	32, +0	Vdc
Storage Temperature Range	$T_{stg}$	-65 to +150	°C
Case Operating Temperature Range	$T_C$	-40 to +150	°C
Operating Junction Temperature Range (1,2)	$T_J$	-40 to +225	°C

**Table 2. Thermal Characteristics**

Characteristic	Symbol	Value (2,3)	Unit
Thermal Resistance, Junction to Case Case Temperature 80°C, 80 W CW, 28 Vdc, $I_{DQ} = 1500$ mA, 960 MHz Case Temperature 91°C, 282 W CW, 28 Vdc, $I_{DQ} = 1500$ mA, 960 MHz	$R_{\theta JC}$	0.31 0.27	°C/W

**Table 3. ESD Protection Characteristics**

Test Methodology	Class
Human Body Model (per JESD22-A114)	2
Machine Model (per EIA/JESD22-A115)	B
Charge Device Model (per JESD22-C101)	IV

**Table 4. Moisture Sensitivity Level**

Test Methodology	Rating	Package Peak Temperature	Unit
Per JESD22-A113, IPC/JEDEC J-STD-020	3	260	°C

**Table 5. Electrical Characteristics** ( $T_A = 25^\circ\text{C}$  unless otherwise noted)

Characteristic	Symbol	Min	Typ	Max	Unit
<b>Off Characteristics</b>					
Zero Gate Voltage Drain Leakage Current ( $V_{DS} = 70$ Vdc, $V_{GS} = 0$ Vdc)	$I_{DSS}$	—	—	10	$\mu\text{Adc}$
Zero Gate Voltage Drain Leakage Current ( $V_{DS} = 28$ Vdc, $V_{GS} = 0$ Vdc)	$I_{DSS}$	—	—	1	$\mu\text{Adc}$
Gate-Source Leakage Current ( $V_{GS} = 5$ Vdc, $V_{DS} = 0$ Vdc)	$I_{GSS}$	—	—	1	$\mu\text{Adc}$
<b>On Characteristics</b>					
Gate Threshold Voltage ( $V_{DS} = 10$ Vdc, $I_D = 370$ $\mu\text{Adc}$ )	$V_{GS(th)}$	1.0	1.5	2.0	Vdc
Gate Quiescent Voltage ( $V_{DD} = 28$ Vdc, $I_D = 1400$ mA, Measured in Functional Test)	$V_{GS(Q)}$	1.7	2.2	2.7	Vdc
Drain-Source On-Voltage ( $V_{GS} = 10$ Vdc, $I_D = 3.6$ Adc)	$V_{DS(on)}$	0.1	0.14	0.3	Vdc

1. Continuous use at maximum temperature will affect MTTF.
2. MTTF calculator available at <http://www.freescale.com/rf>. Select Software & Tools/Development Tools/Calculators to access MTTF calculators by product.
3. Refer to AN1955, *Thermal Measurement Methodology of RF Power Amplifiers*. Go to <http://www.freescale.com/rf>. Select Documentation/Application Notes - AN1955.

(continued)

**Table 5. Electrical Characteristics** ( $T_A = 25^\circ\text{C}$  unless otherwise noted) (continued)

Characteristic	Symbol	Min	Typ	Max	Unit
<b>Functional Tests</b> <sup>(1)</sup> (In Freescale Test Fixture, 50 ohm system) $V_{DD} = 28\text{ Vdc}$ , $I_{DQ} = 1400\text{ mA}$ , $P_{out} = 80\text{ W Avg.}$ , $f = 960\text{ MHz}$ , Single-Carrier W-CDMA, IQ Magnitude Clipping, Input Signal PAR = 7.5 dB @ 0.01% Probability on CCDF. ACPR measured in 3.84 MHz Channel Bandwidth @ $\pm 5\text{ MHz}$ Offset.					
Power Gain	$G_{ps}$	19.0	20.0	22.0	dB
Drain Efficiency	$\eta_D$	33.5	36.1	—	%
Output Peak-to-Average Ratio @ 0.01% Probability on CCDF	PAR	5.6	6.1	—	dB
Adjacent Channel Power Ratio	ACPR	—	-37.5	-36.0	dBc
Input Return Loss	IRL	—	-17	-10	dB

**Load Mismatch** (In Freescale Test Fixture, 50 ohm system)  $I_{DQ} = 1400\text{ mA}$ ,  $f = 940\text{ MHz}$ 

VSWR 10:1 at 32 Vdc, 416 W CW Output Power (3 dB Input Overdrive from 280 W CW Rated Power)	No Device Degradation
--	-----------------------

**Typical Performance** (In Freescale Test Fixture, 50 ohm system)  $V_{DD} = 28\text{ Vdc}$ ,  $I_{DQ} = 1400\text{ mA}$ , 920-960 MHz Bandwidth

$P_{out}$ @ 1 dB Compression Point, CW	P1dB	—	280	—	W
VBW Resonance Point (IMD Third Order Intermodulation Inflection Point)	VBW <sub>res</sub>	—	60	—	MHz
Gain Flatness in 40 MHz Bandwidth @ $P_{out} = 80\text{ W Avg.}$	$G_F$	—	0.1	—	dB
Gain Variation over Temperature ( $-30^\circ\text{C}$ to $+85^\circ\text{C}$ )	$\Delta G$	—	0.0156	—	dB/ $^\circ\text{C}$
Output Power Variation over Temperature ( $-30^\circ\text{C}$ to $+85^\circ\text{C}$ )	$\Delta P1dB$	—	0.006	—	dB/ $^\circ\text{C}$

1. Part internally matched both on input and output.

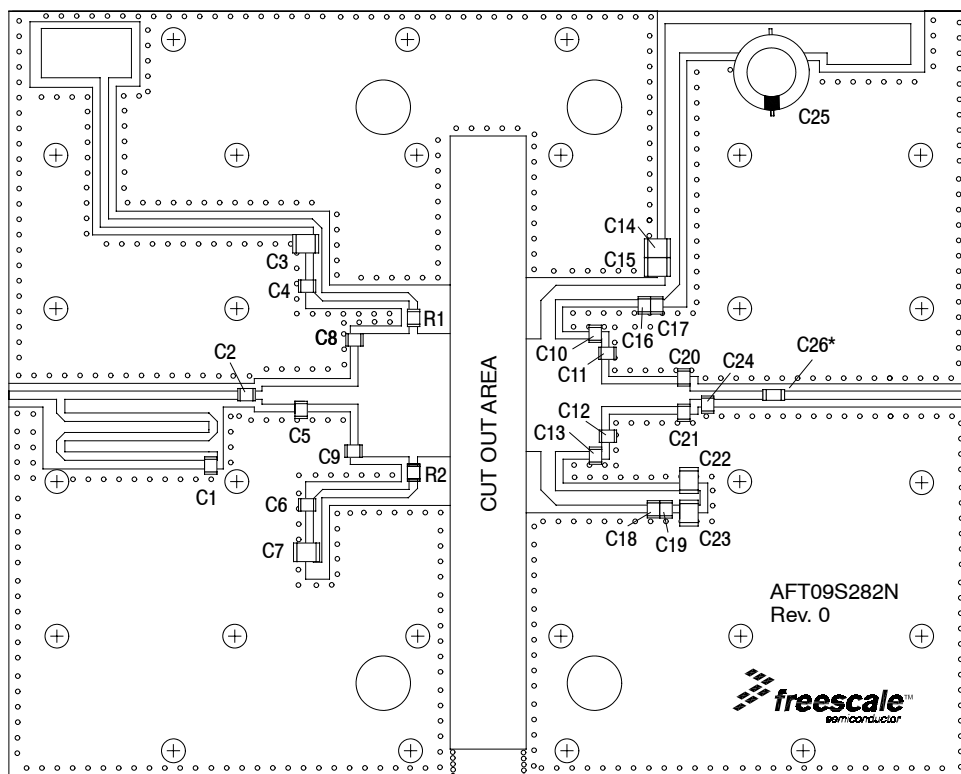

\*C26 is mounted vertically.

**Figure 2. AFT09S282NR3 Test Circuit Component Layout**

**Table 6. AFT09S282NR3 Test Circuit Component Designations and Values**

Part	Description	Part Number	Manufacturer
C1	62 pF Chip Capacitor	ATC100B620JT500XT	ATC
C2, C5, C10, C13	4.7 pF Chip Capacitors	ATC600F4R7BT250XT	ATC
C3, C7, C14, C15, C22, C23	10 $\mu$ F Chip Capacitors	GRM32ER71H106KA12L	Murata
C4, C6, C16, C17, C18, C19	47 pF Chip Capacitors	ATC600F470JT250XT	ATC
C8, C9, C11, C24	3.9 pF Chip Capacitors	ATC600F3R9BT250XT	ATC
C12, C20, C21	2.4 pF Chip Capacitors	ATC600F2R4BT250XT	ATC
C25	470 $\mu$ F, 63 V Electrolytic Capacitor	MCGPR63V477M13X26-RH	Multicomp
C26	36 pF Chip Capacitor	ATC100B360JT500XT	ATC
R1, R2	6.04 $\Omega$ , 1/4 W Chip Resistor	CRCW12066R04FKEA	Vishay
PCB	0.020", $\epsilon_r = 3.5$	RO4350	Rogers

### TYPICAL CHARACTERISTICS

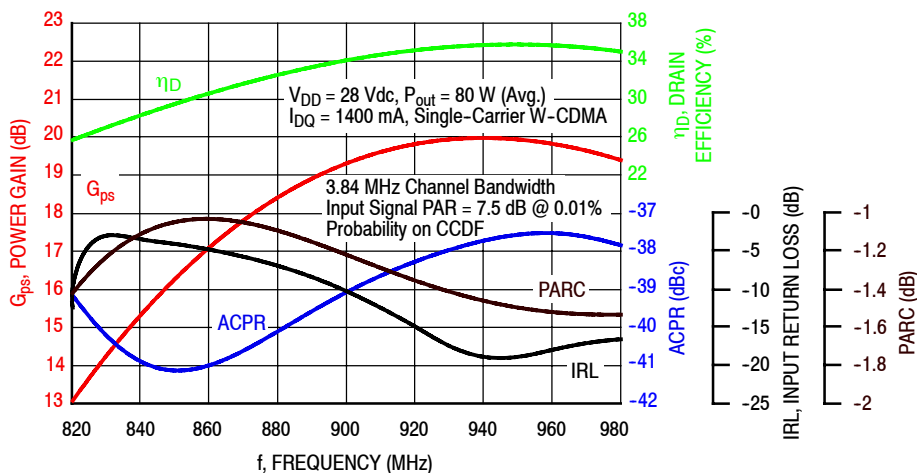

Figure 3. Single-Carrier Output Peak-to-Average Ratio Compression (PARC) Broadband Performance @  $P_{out} = 80$  Watts Avg.

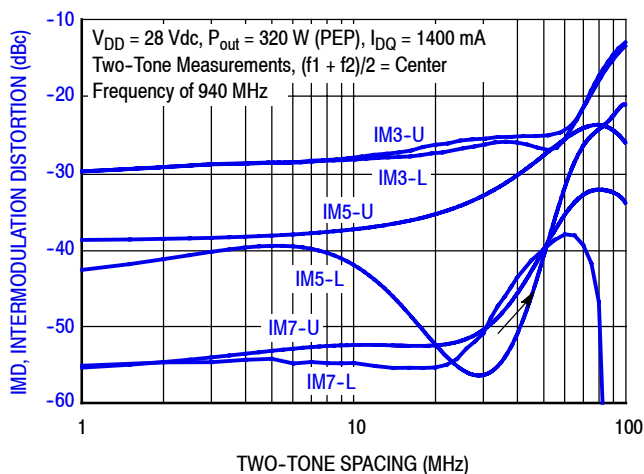

Figure 4. Intermodulation Distortion Products versus Two-Tone Spacing

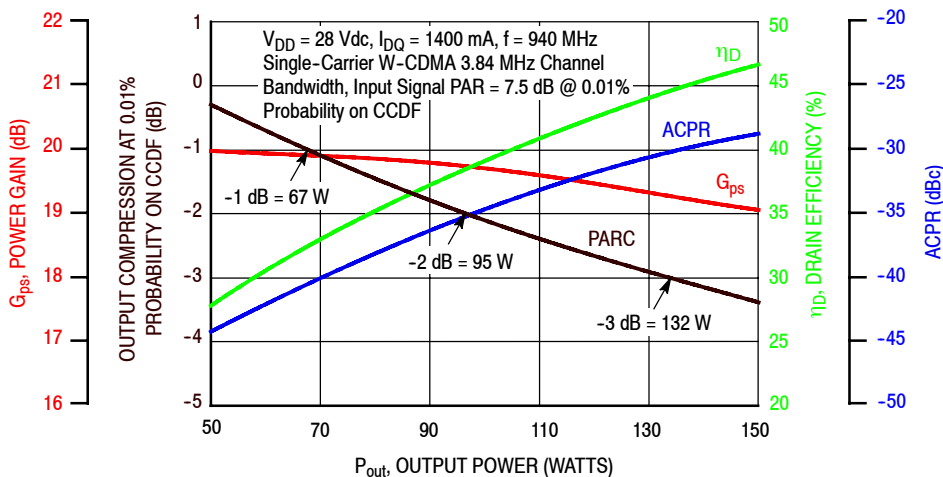
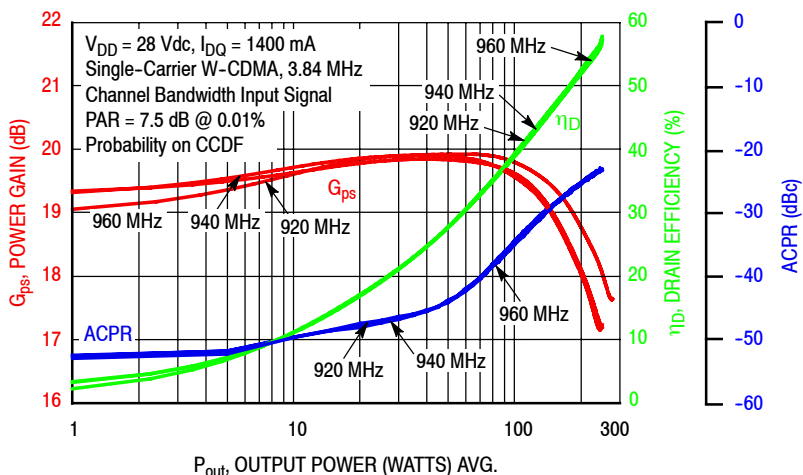
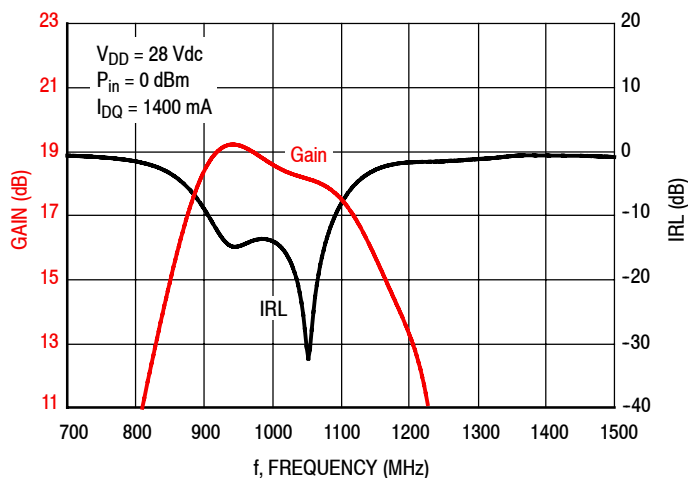

Figure 5. Output Peak-to-Average Ratio Compression (PARC) versus Output Power

### TYPICAL CHARACTERISTICS



**Figure 6. Single-Carrier W-CDMA Power Gain, Drain Efficiency and ACPR versus Output Power**



**Figure 7. Broadband Frequency Response**

$V_{DD} = 28 \text{ Vdc}$ ,  $I_{DQ} = 1400 \text{ mA}$ , Pulsed CW, 10  $\mu\text{sec}(\text{on})$ , 10% Duty Cycle

f (MHz)	$Z_{\text{source}}$ ( $\Omega$ )	$Z_{\text{in}}$ ( $\Omega$ )	$Z_{\text{load}}^{(1)}$ ( $\Omega$ )	Max Linear Gain (dB)	Max Output Power							
					P1dB				P3dB			
					(dBm)	(W)	$\eta_D$ (%)	AM/PM ( $^\circ$ )	(dBm)	(W)	$\eta_D$ (%)	AM/PM ( $^\circ$ )
920	1.83 - j3.18	1.66 + j3.17	4.55 - j3.27	18.7	56.0	396	53.5	-8.0	56.9	494	58.2	-12
940	2.01 - j3.27	2.03 + j3.31	4.97 - j2.86	18.7	55.9	391	54.4	-7.7	56.9	490	57.6	-11
960	2.64 - j3.34	2.55 + j3.45	5.77 - j1.78	18.4	55.9	391	53.9	-7.9	56.9	488	57.8	-12

(1) Load impedance for optimum P1dB power.

$Z_{\text{source}}$  = Measured impedance presented to the input of the device at the package reference plane.

$Z_{\text{in}}$  = Impedance as measured from gate contact to ground.

$Z_{\text{load}}$  = Measured impedance presented to the output of the device at the package reference plane.

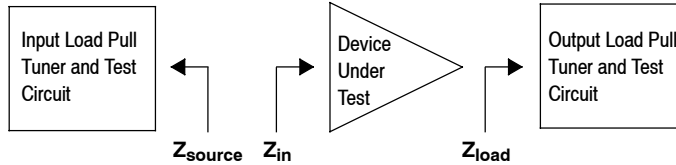

Figure 8. Load Pull Performance — Maximum P1dB Tuning

$V_{DD} = 28 \text{ Vdc}$ ,  $I_{DQ} = 1400 \text{ mA}$ , Pulsed CW, 10  $\mu\text{sec}(\text{on})$ , 10% Duty Cycle

f (MHz)	$Z_{\text{source}}$ ( $\Omega$ )	$Z_{\text{in}}$ ( $\Omega$ )	$Z_{\text{load}}^{(1)}$ ( $\Omega$ )	Max Linear Gain (dB)	Max Drain Efficiency							
					P1dB				P3dB			
					(dBm)	(W)	$\eta_D$ (%)	AM/PM ( $^\circ$ )	(dBm)	(W)	$\eta_D$ (%)	AM/PM ( $^\circ$ )
920	1.83 - j3.18	1.70 + j3.02	1.49 - j1.61	22.0	53.5	225	66.2	-15	54.3	267	69.6	-22
940	2.01 - j3.27	2.12 + j3.16	1.48 - j1.80	22.0	53.3	215	66.6	-16	54.0	248	70.1	-24
960	2.64 - j3.34	2.66 + j3.26	1.76 - j1.79	21.7	53.6	230	67.4	-15	54.3	269	70.6	-22

(1) Load impedance for optimum P1dB efficiency.

$Z_{\text{source}}$  = Measured impedance presented to the input of the device at the package reference plane.

$Z_{\text{in}}$  = Impedance as measured from gate contact to ground.

$Z_{\text{load}}$  = Measured impedance presented to the output of the device at the package reference plane.

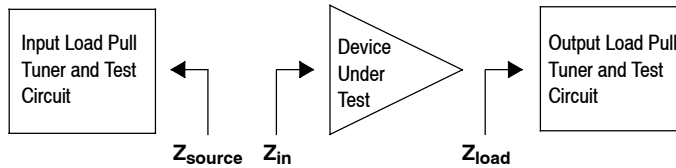

Figure 9. Load Pull Performance — Maximum Drain Efficiency Tuning

## P1dB - TYPICAL LOAD PULL CONTOURS — 940 MHz

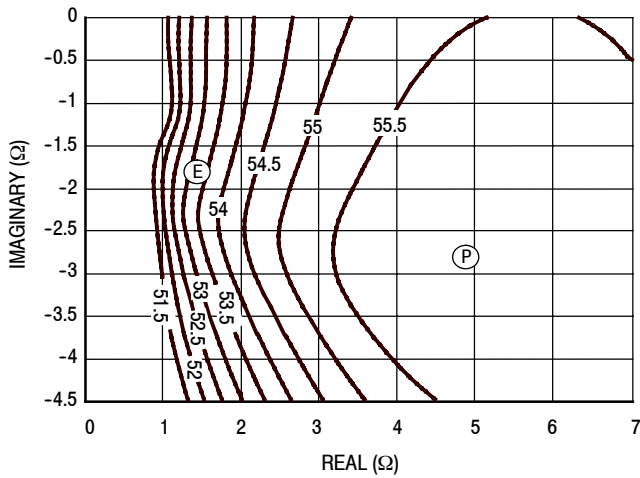

Figure 10. P1dB Load Pull Output Power Contours (dBm)

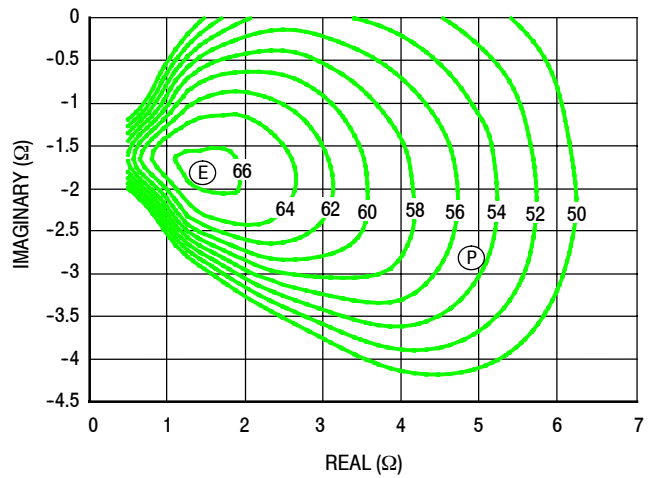

Figure 11. P1dB Load Pull Efficiency Contours (%)

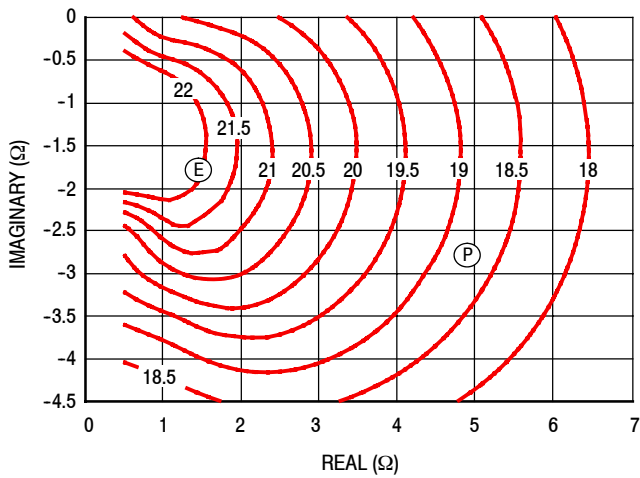

Figure 12. P1dB Load Pull Gain Contours (dB)

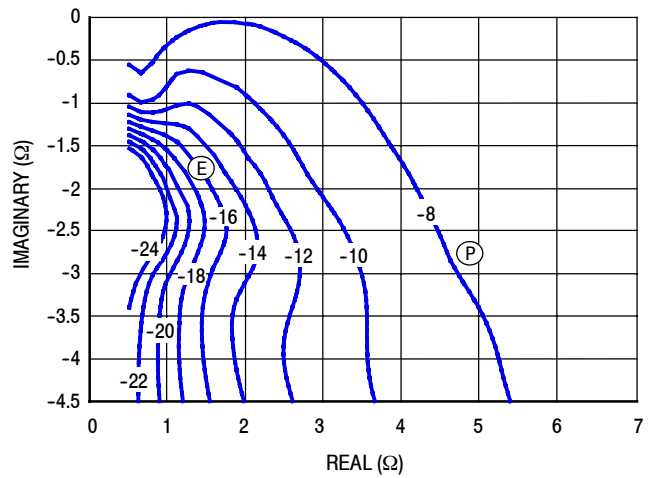

Figure 13. P1dB Load Pull AM/PM Contours (°)

**NOTE:** (P) = Maximum Output Power  
 (E) = Maximum Drain Efficiency

- Power Gain
- Drain Efficiency
- Linearity
- Output Power



P3dB - TYPICAL LOAD PULL CONTOURS — 940 MHz

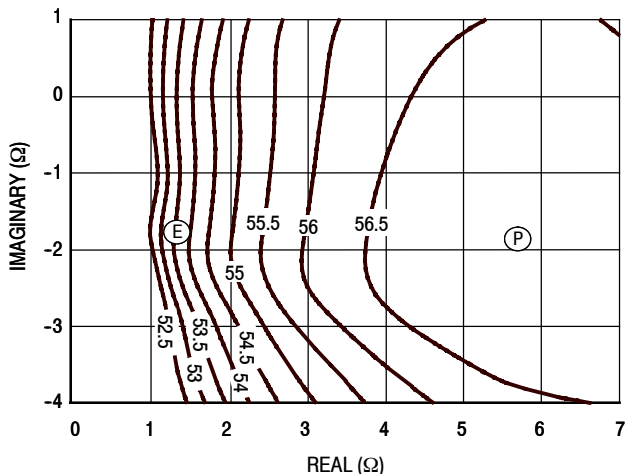

Figure 14. P3dB Load Pull Output Power Contours (dBm)

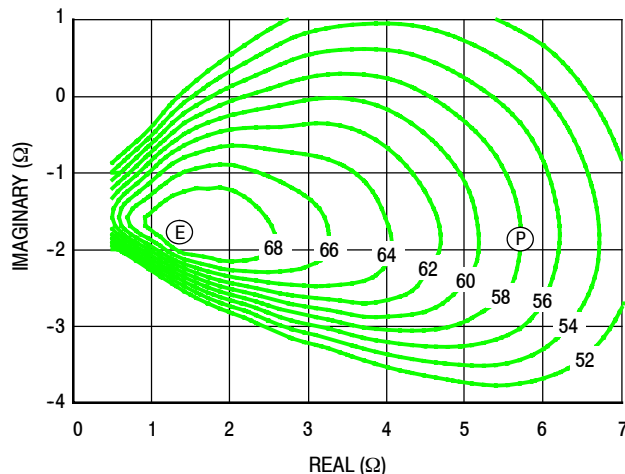

Figure 15. P3dB Load Pull Efficiency Contours (%)

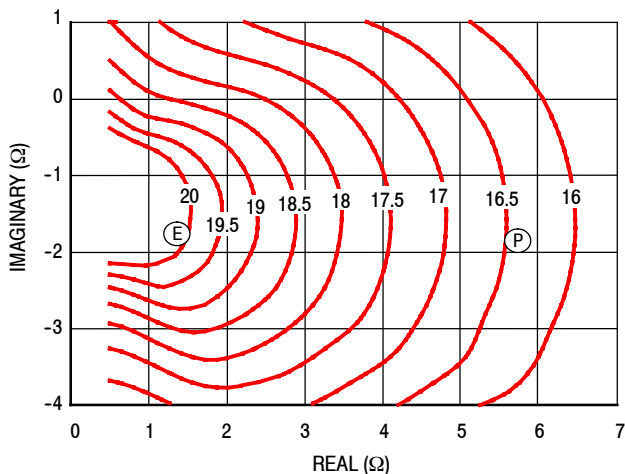

Figure 16. P3dB Load Pull Gain Contours (dB)

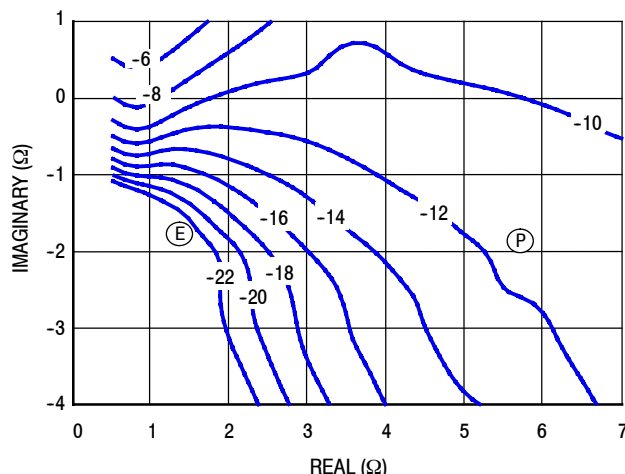
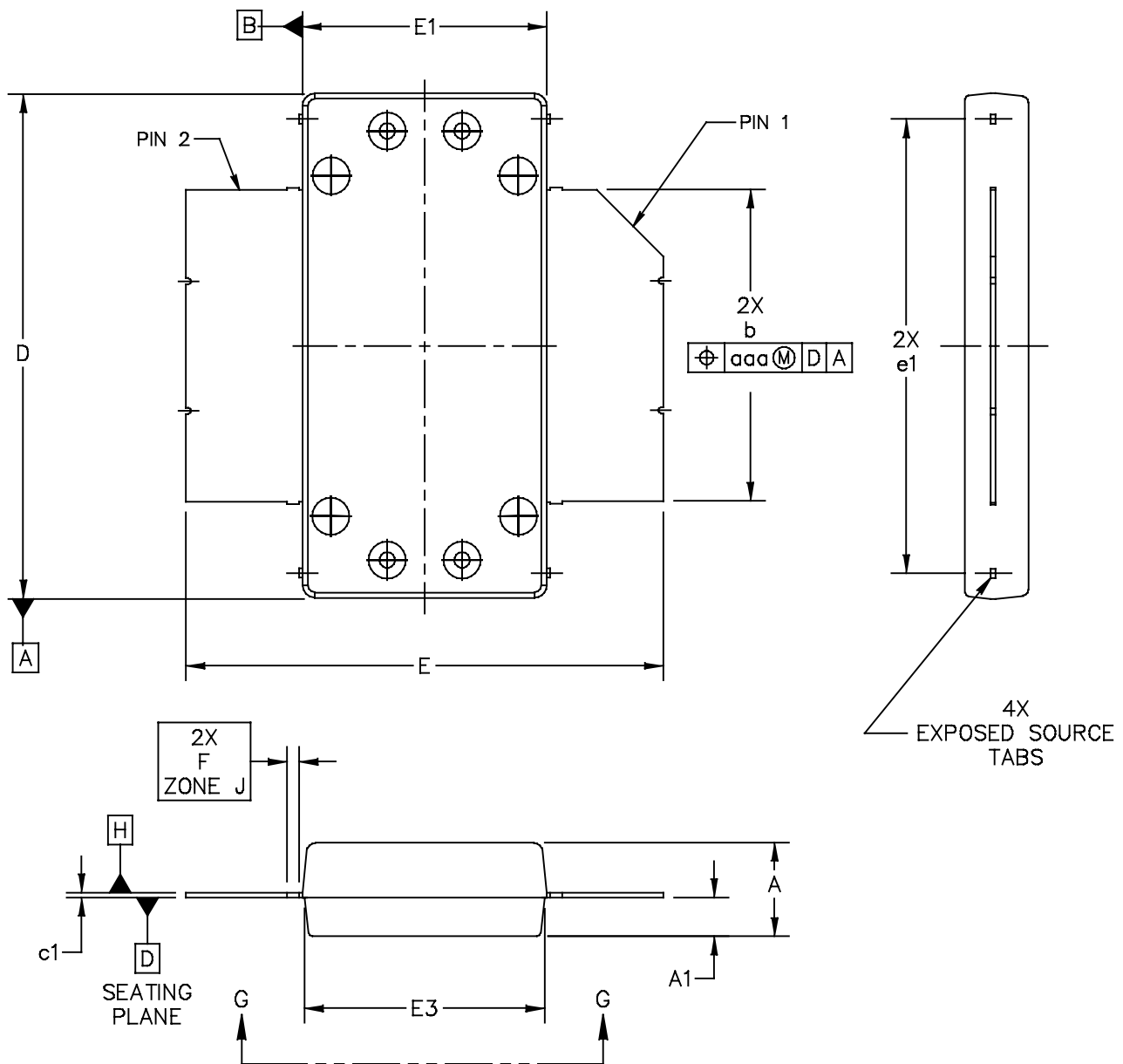

Figure 17. P3dB Load Pull AM/PM Contours (°)

NOTE: (P) = Maximum Output Power  
(E) = Maximum Drain Efficiency

- Power Gain
- Drain Efficiency
- Linearity
- Output Power

### PACKAGE DIMENSIONS



© FREESCALE SEMICONDUCTOR, INC. ALL RIGHTS RESERVED.	MECHANICAL OUTLINE	PRINT VERSION NOT TO SCALE
TITLE: OM780-2 STRAIGHT LEAD	DOCUMENT NO: 98ASA10831D	REV: B
	CASE NUMBER: 2021-03	22 OCT 2009
	STANDARD: NON-JEDEC	

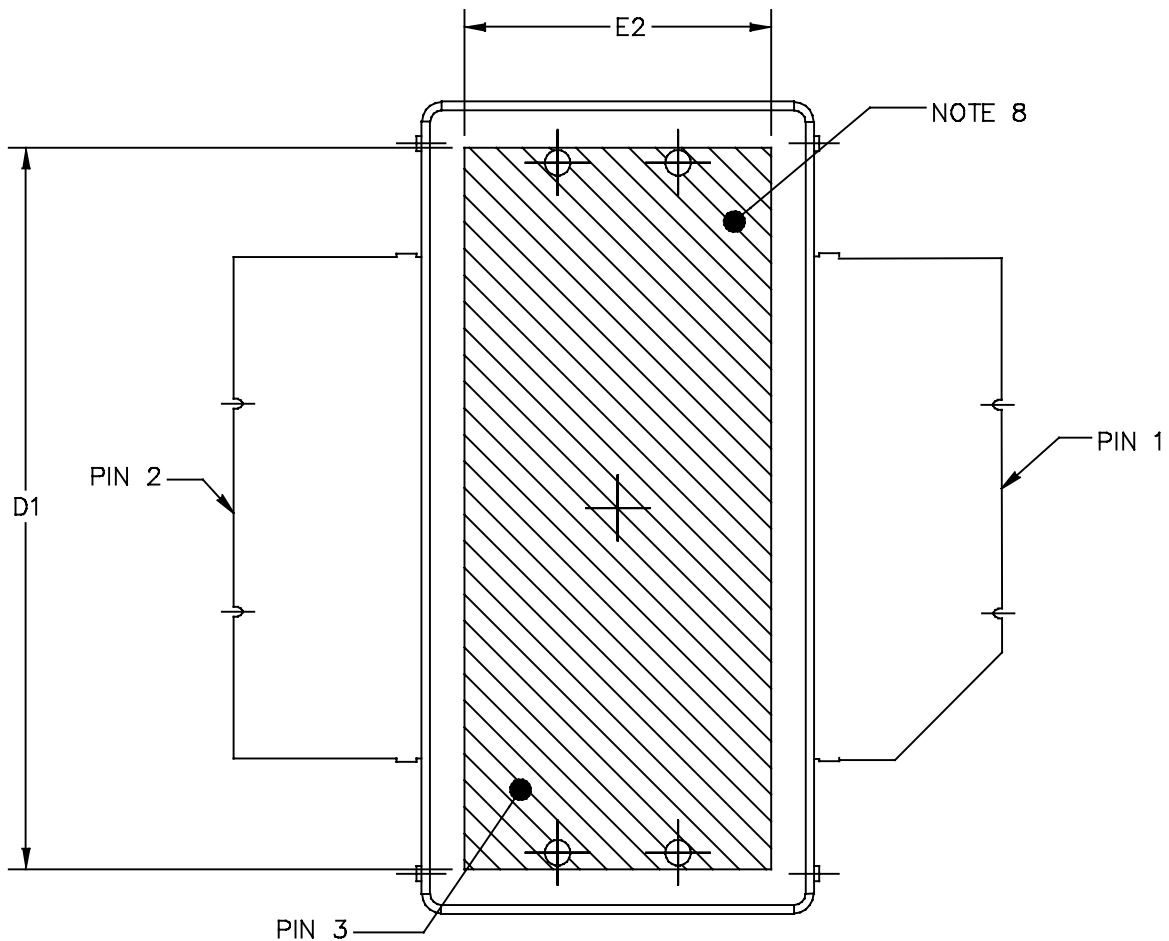

BOTTOM VIEW  
VIEW G-G

© FREESCALE SEMICONDUCTOR, INC. ALL RIGHTS RESERVED.	MECHANICAL OUTLINE	PRINT VERSION NOT TO SCALE	
TITLE: OM780-2 STRAIGHT LEAD	DOCUMENT NO: 98ASA10831D	REV: B	
	CASE NUMBER: 2021-03	22 OCT 2009	
	STANDARD: NON-JEDEC		

NOTES:

1. CONTROLLING DIMENSION: INCH
2. INTERPRET DIMENSIONS AND TOLERANCES PER ASME Y14.5M-1994.
3. DATUM PLANE -H- IS LOCATED AT TOP OF LEAD AND IS COINCIDENT WITH THE LEAD WHERE THE LEAD EXITS THE PLASTIC BODY AT THE TOP OF THE PARTING LINE.
4. DIMENSIONS "D" AND "E1" DO NOT INCLUDE MOLD PROTRUSION. ALLOWABLE PROTRUSION IS .006 PER SIDE. DIMENSIONS "D AND "E1" DO INCLUDE MOLD MISMATCH AND ARE DETERMINED AT DATUM PLANE -H-.
5. DIMENSION b DOES NOT INCLUDE DAMBAR PROTRUSION. ALLOWABLE DAMBAR PROTRUSION SHALL BE .005 TOTAL IN EXCESS OF THE b DIMENSION AT MAXIMUM MATERIAL CONDITION.
6. DATUMS -A- AND -B- TO BE DETERMINED AT DATUM PLANE -H-.
7. DIMENSION A1 APPLIES WITHIN ZONE "J" ONLY
8. HATCHING REPRESENTS THE EXPOSED AREA OF THE HEAT SLUG. THE DIMENSIONS D1 AND E2 REPRESENT THE VALUES BETWEEN THE TWO OPPOSITE POINTS ALONG THE EDGES OF EXPOSED AREA OF HEAT SLUG.

STYLE 1:

- PIN 1 - DRAIN
- PIN 2 - GATE
- PIN 3 - SOURCE

DIM	INCH		MILLIMETER		DIM	INCH		MILLIMETER	
	MIN	MAX	MIN	MAX		MIN	MAX	MIN	MAX
A	0.148	.152	3.76	3.86	b	.497	.503	12.62	12.78
A1	.059	.065	1.50	1.65	c1	.007	.011	0.18	0.28
D	.808	.812	20.52	20.62	e1	.721	.729	18.31	18.52
D1	.720	----	18.29	----					
E	.762	.770	19.36	19.56	aaa	.004		0.10	
E1	.390	.394	9.91	10.01					
E2	.306	----	7.77	----					
E3	.383	.387	9.73	9.83					
F	.025 BSC		0.635 BSC						
© FREESCALE SEMICONDUCTOR, INC. ALL RIGHTS RESERVED.			MECHANICAL OUTLINE			PRINT VERSION NOT TO SCALE			
TITLE:  OM780-2 STRAIGHT LEAD					DOCUMENT NO: 98ASA10831D			REV: B	
					CASE NUMBER: 2021-03			22 OCT 2009	
					STANDARD: NON-JEDEC				

## PRODUCT DOCUMENTATION, SOFTWARE AND TOOLS

Refer to the following documents, software and tools to aid your design process.

### Application Notes

- AN1955: Thermal Measurement Methodology of RF Power Amplifiers

### Engineering Bulletins

- EB212: Using Data Sheet Impedances for RF LDMOS Devices

### Software

- Electromigration MTTF Calculator
- RF High Power Model
- .s2p File

### Development Tools

- Printed Circuit Boards

For Software and Tools, do a Part Number search at <http://www.freescale.com>, and select the "Part Number" link. Go to the Software & Tools tab on the part's Product Summary page to download the respective tool.

## REVISION HISTORY

The following table summarizes revisions to this document.

Revision	Date	Description
0	Oct. 2012	• Initial Release of Data Sheet

## ***How to Reach Us:***

**Home Page:**  
[freescale.com](http://freescale.com)

**Web Support:**  
[freescale.com/support](http://freescale.com/support)

Information in this document is provided solely to enable system and software implementers to use Freescale products. There are no express or implied copyright licenses granted hereunder to design or fabricate any integrated circuits based on the information in this document.

Freescale reserves the right to make changes without further notice to any products herein. Freescale makes no warranty, representation, or guarantee regarding the suitability of its products for any particular purpose, nor does Freescale assume any liability arising out of the application or use of any product or circuit, and specifically disclaims any and all liability, including without limitation consequential or incidental damages. "Typical" parameters that may be provided in Freescale data sheets and/or specifications can and do vary in different applications, and actual performance may vary over time. All operating parameters, including "typicals," must be validated for each customer application by customer's technical experts. Freescale does not convey any license under its patent rights nor the rights of others. Freescale sells products pursuant to standard terms and conditions of sale, which can be found at the following address: [freescale.com/SalesTermsandConditions](http://freescale.com/SalesTermsandConditions).

Freescale, the Freescale logo, Altivec, C-5, CodeTest, CodeWarrior, ColdFire, C-Ware, Energy Efficient Solutions logo, Kinetis, mobileGT, PowerQUICC, Processor Expert, QorIQ, Qorivva, StarCore, Symphony, and VortiQa are trademarks of Freescale Semiconductor, Inc., Reg. U.S. Pat. & Tm. Off. Airfast, BeeKit, BeeStack, ColdFire+, CoreNet, Flexis, MagniV, MXC, Platform in a Package, QorIQ Qonverge, QUICC Engine, Ready Play, SafeAssure, SMARTMOS, TurboLink, Vybrid, and Xtrinsic are trademarks of Freescale Semiconductor, Inc. All other product or service names are the property of their respective owners.

© 2012 Freescale Semiconductor, Inc.

