

Fast Switching SCR T7SH_40

400A Avg.
(700 RMS)
Up to 1200 Volts
10-50 μ s

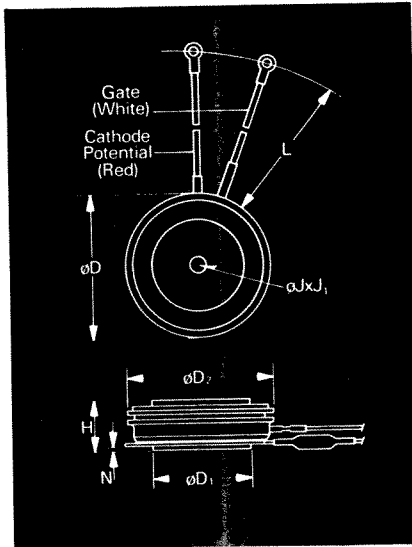

Symbol	Inches		Millimeters	
	Min.	Max.	Min.	Max.
ϕD	1.850	1.900	45.72	48.26
ϕD_1	1.140	1.180	28.96	29.97
ϕD_2	1.760	1.850	44.70	46.99
H	.545	.605	13.84	15.37
ϕJ	.135	.145	3.43	3.68
J_1	.072	.082	1.83	2.08
L	7.75	8.50	196.85	215.90
N	.025		.64	

Creep Distance—.41 in. min. (10.41 mm).
Strike Distance—.35 in. min. (8.89 mm).
Finish-Nickel Plate.
Approx. Weight—4 oz. (113 g.)
1. Dimension "H" is a clamped dimension.

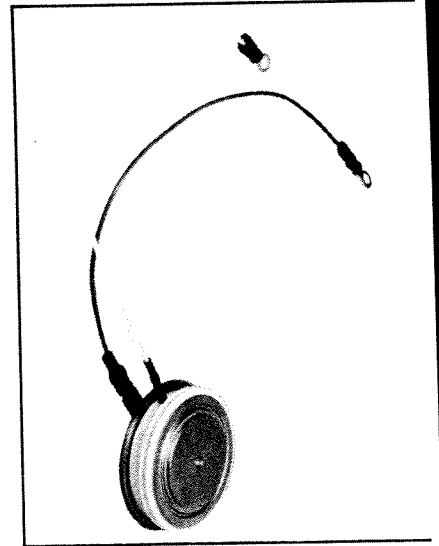

T7S Outline

Features:

- Interdigitated, di/namic Gate structure
- Hard Commutation Turn-Off
- Forward Blocking Voltage Capabilities to 1200 Volts
- Low Switching Losses at High Frequency
- Soft Commutation (Feedback Diode) Testing Available
- High di/dt with softgate control

Applications:

- Induction Heating
- Transportation
- Inverters
- Crowbars
- Cycloconverters

Ordering Information

Type Code	Voltage		Current		Turn-off		Gate current		Leads		
	V_{DRM} and V_{RRM} (V)	Code	$I_{T(av)}$ (A)	Code	t_q usec	Code	I_{GT} (ma)	Code	Case	Code	
T7SH	100	01	400	40	10	8	~ 150	4	T7S	DN	
	200	02			15						7
	300	03			20						6
	400	04			25						5
	500	05			30						4
	600	06			40						4
	700	07			50						3
	800	08									
	900	09									
	1000	10									
	1100	11									
	1200	12									

Example

Obtain optimum device performance for your application by selecting proper Order Code.

Type T72H rated at 400A average with $V_{DRM} = 1000V$,
 $I_{GT} = 150 \text{ ma}$, $t_q = 30 \mu\text{sec}$ max. and leads—order as:

Type	Voltage	Current	Turn Off	Gate Current	Leads
T 7 S H	1 0	4 0	5	4	D N

**400A Avg.
(700 RMS)
Up to 1200 Volts
10-50 μ s**

**Fast Switching
SCR
T7SH_40**

Voltage ②

Blocking State Maximums ($T_J = 125^\circ\text{C}$)

Symbol	100	200	300	400	500	600	700	800	900	1000	1100	1200
Repetitive peak forward blocking voltage, V V_{DRM}	100	200	300	400	500	600	700	800	900	1000	1100	1200
Repetitive peak reverse voltage, V V_{RRM}	100	200	300	400	500	600	700	800	900	1000	1100	1200
Non-repetitive transient peak reverse voltage, $t \leq 5.0$ msec, V V_{RSM}	200	300	400	500	600	700	800	900	1000	1100	1200	1300
Forward leakage current, mA peak I_{DRM}	← 35 →											
Reverse leakage current, mA peak I_{RRM}	← 35 →											

Current

Conducting State Maximums ($T_J = 125^\circ\text{C}$)

Symbol	T7SH_40
RMS forward current, A $I_T(\text{rms})$	628
Ave. forward current, A $I_T(\text{av})$	400
One-half cycle surge current ^③ , A I_{TSM}	8000
3 cycle surge current ^③ , A I_{TSM}	5765
10 cycle surge current ^③ , A I_{TSM}	4980
I^2t for fusing (for times ≥ 8.3 ms) I^2t	267,000
Forward voltage drop at $I_{TM} = 1500\text{A}$ and $T_J = 25^\circ\text{C}$, V V_{TM}	3.15
Min. repetitive di/dt ^{①④⑤} A/ μ sec di/dt	500

Switching

($T_J = 25^\circ\text{C}$)

Symbol	
Max. turn-off time, $I_T = 1000\text{A}$, $T_J = 125^\circ\text{C}$ $t_p = 100 \mu\text{sec}$, $di/dt = 50$ A/ μ sec., reappplied $dv/dt = 200\text{V}/\mu\text{sec}$. linear to $0.8 V_{DRM}$, μsec . ^{①②} t_q	10 to 50
Typ. delay time, $I_{TM} = 1000\text{A}$ $T_D = .8 V_{DRM}$, μsec t_d	.5
Min. critical dv/dt exponential to $.8 V_{DRM}$, $T_J = 125^\circ\text{C}$, V/ μ sec ^{③④} dv/dt	300
Min. di/dt , non-repetitive, A/ μ sec ^{①④⑤} di/dt	1200

Gate

Maximum Parameters ($T_J = 25^\circ\text{C}$)

Symbol	
Gate current to trigger at $V_D = 12\text{V}$, mA I_{GT}	150
Gate voltage to trigger at $V_D = 12\text{V}$, V V_{GT}	3
Non-triggering gate voltage, $T_J = 125^\circ\text{C}$, and rated V_{DRM} , V V_{GDM}	.25
Peak forward gate current, A I_{GTM}	4
Peak reverse gate voltage, V V_{GRM}	5
Peak gate power, Watts P_{GM}	16
Average gate power, Watts $P_{G(\text{av})}$	3

Thermal and Mechanical

Symbol	
Min., Max. oper. junction temp., $^\circ\text{C}$ T_J	-40 to +125
Min., Max. storage temp., $^\circ\text{C}$ T_{stg}	-40 to +150
Max. mounting force, lb. ^①	2000 to 2400
Thermal resistance ^② , double-side cooling, junction to case, $^\circ\text{C}/\text{Watt}$ $R_{\theta JC}$.045
Case to sink, lubricated, $^\circ\text{C}/\text{Watt}$ $R_{\theta CS}$.02

- ① Consult recommended mounting procedures.
- ② Applies for zero or negative gate bias.
- ③ Per JEDEC RS-397, 5.2.2.1.
- ④ With recommended gate drive.
- ⑤ Higher dv/dt ratings available, consult factory.
- ⑥ Per JEDEC standard RS-397, 5.2.2.6.
- ⑦ For operation with antiparallel diode, consult factory.

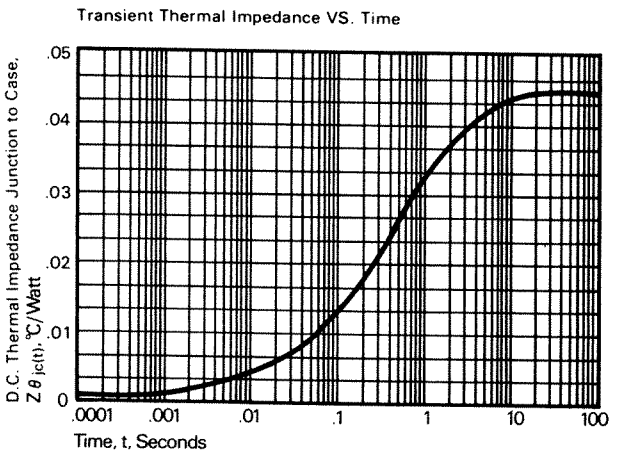
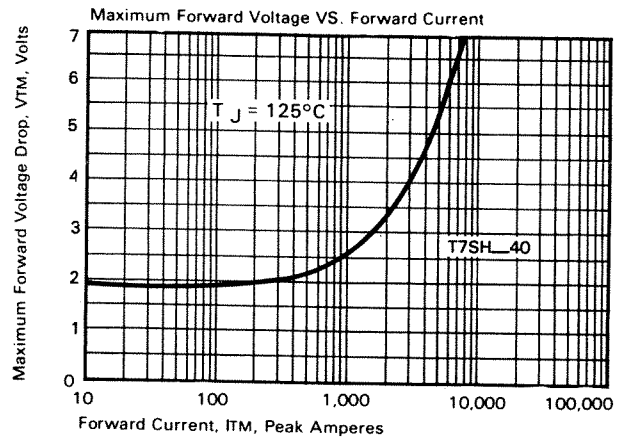

FAST SWITCHING THYRISTORS

Fast Switching SCR T7SH_40

400A Avg.
(700 RMS)
Up to 1200 Volts
10-50 μ s

Sinusoidal Current Data

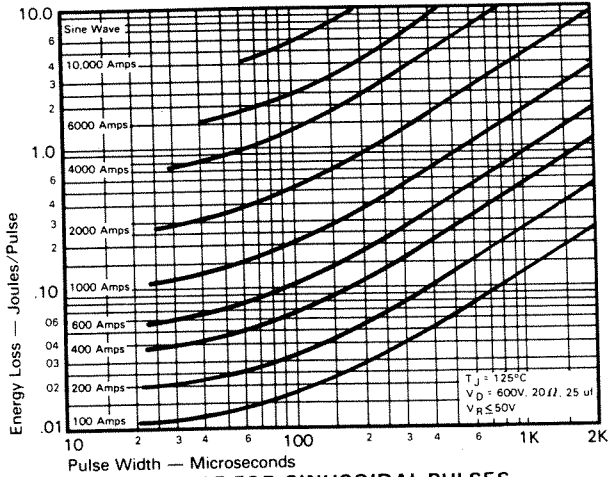

ENERGY PER PULSE FOR SINUSOIDAL PULSES

Trapezoidal Wave Current Data

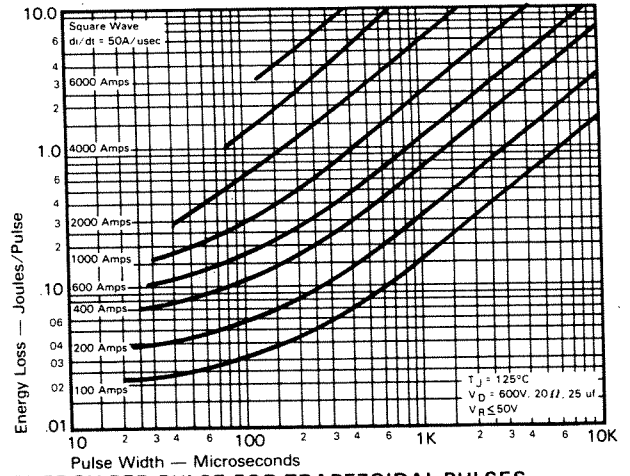

ENERGY PER PULSE FOR TRAPEZOIDAL PULSES
($di/dt = 50\text{A/usec}$)

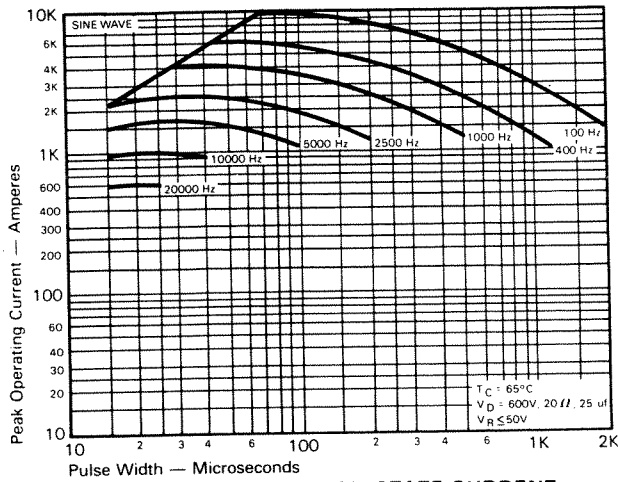

MAXIMUM ALLOWABLE PEAK ON-STATE CURRENT
vs. PULSE WIDTH ($T_C = 65^\circ\text{C}$)

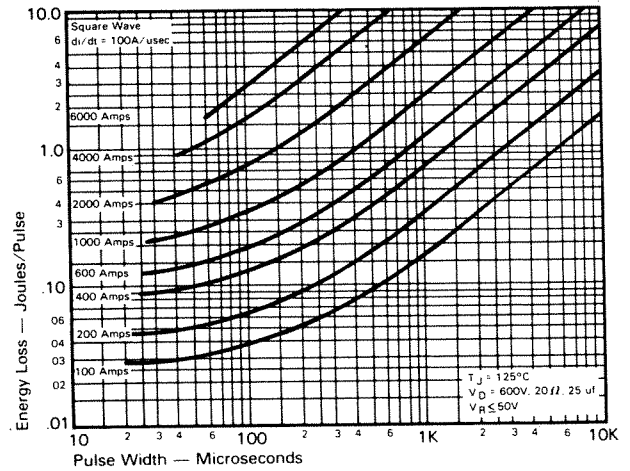

ENERGY PER PULSE FOR TRAPEZOIDAL PULSES
($di/dt = 100\text{A/usec}$)

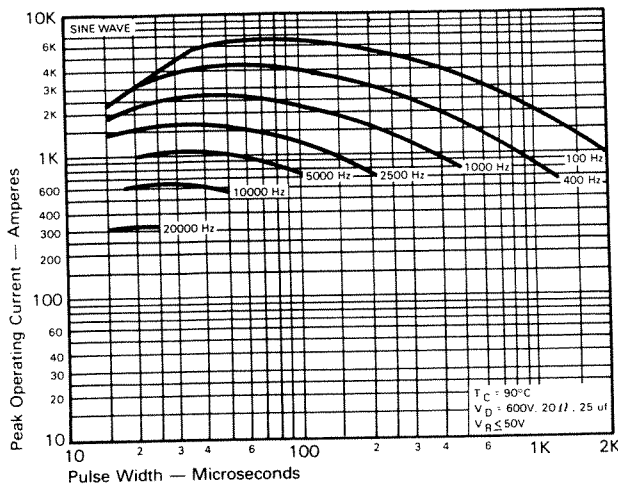

MAXIMUM ALLOWABLE PEAK ON-STATE CURRENT
vs. PULSE WIDTH ($T_C = 90^\circ\text{C}$)

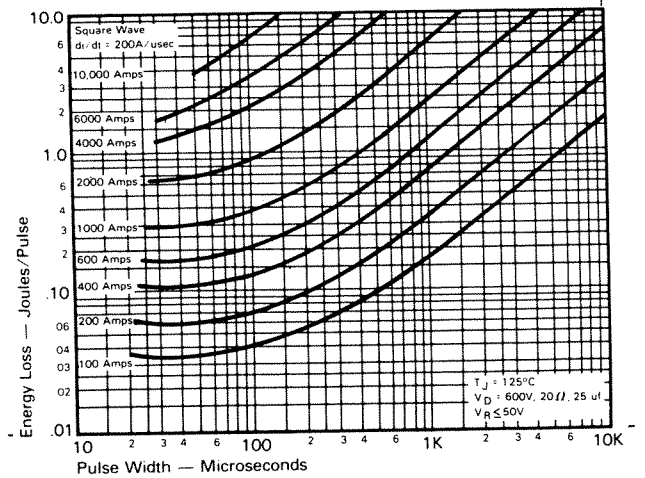

ENERGY PER PULSE FOR TRAPEZOIDAL PULSES
($di/dt = 200\text{A/usec}$)

**400A Avg.
(700 RMS)
Up to 1200 Volts
10-50 μ s**

**Fast Switching
SCR
T7SH_40**

**Trapezoidal Wave Current Data
($T_C = 65^\circ\text{C}$)**

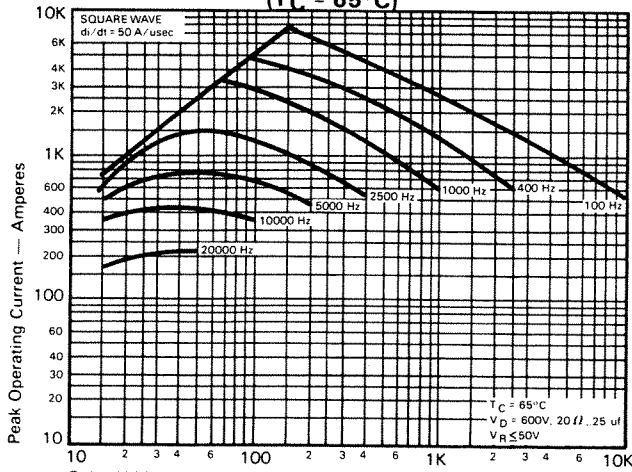

MAXIMUM ALLOWABLE PEAK ON-STATE CURRENT vs. PULSE WIDTH ($di/dt = 50\text{A/usec}$)

**Trapezoidal Wave Current Data
($T_C = 90^\circ\text{C}$)**

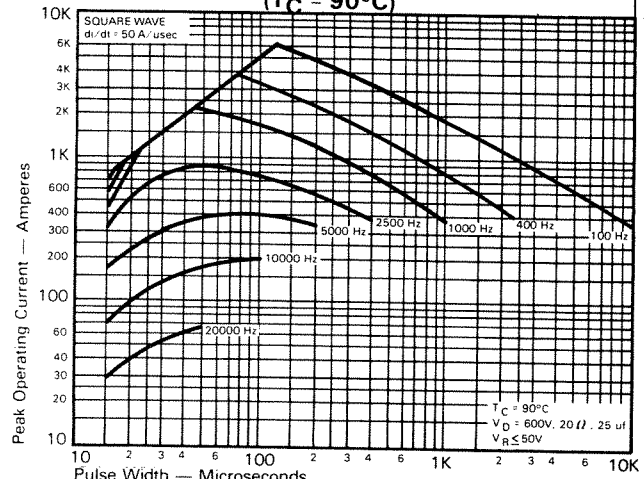

MAXIMUM ALLOWABLE PEAK ON-STATE CURRENT vs. PULSE WIDTH ($di/dt = 50\text{A/usec}$)

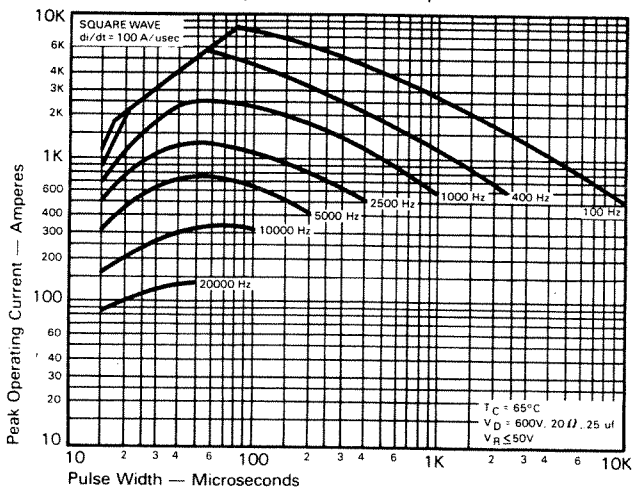

MAXIMUM ALLOWABLE PEAK ON-STATE CURRENT vs. PULSE WIDTH ($di/dt = 100\text{A/usec}$)

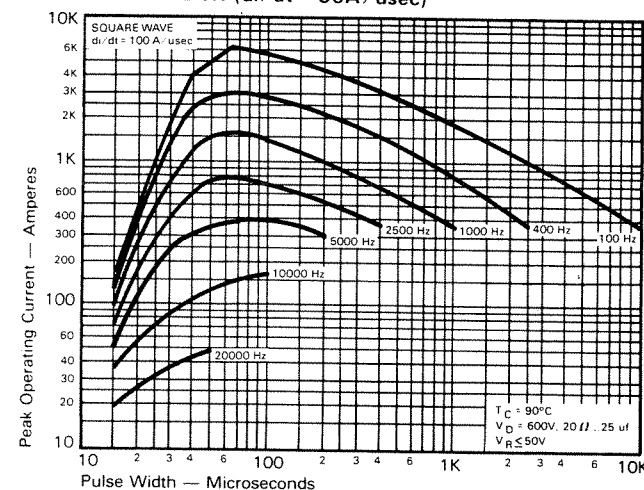

MAXIMUM ALLOWABLE PEAK ON-STATE CURRENT vs. PULSE WIDTH ($di/dt = 100\text{A/usec}$)

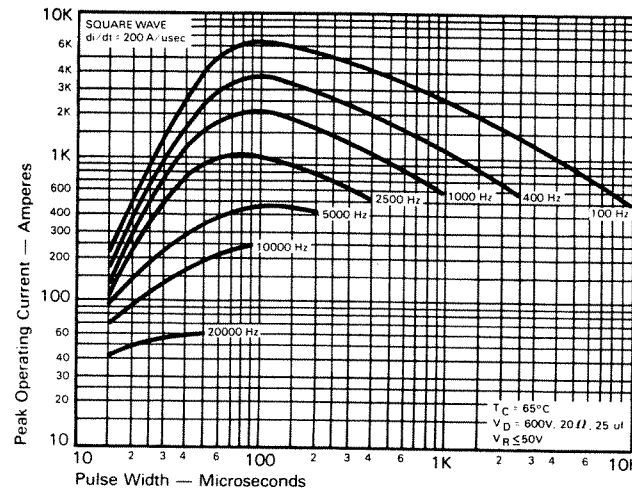

MAXIMUM ALLOWABLE PEAK ON-STATE CURRENT vs. PULSE WIDTH ($di/dt = 200\text{A/usec}$)

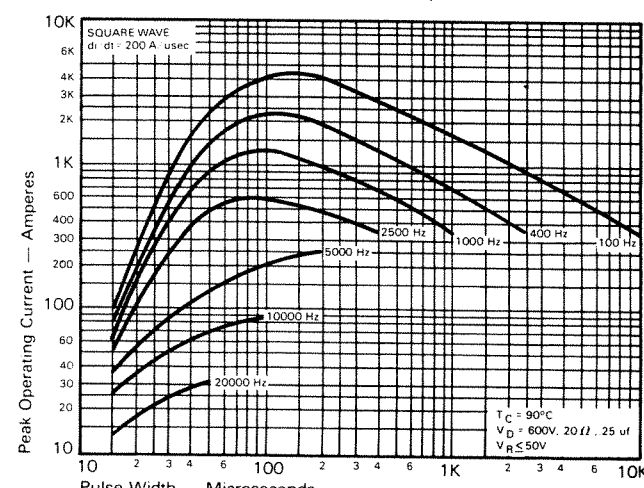

MAXIMUM ALLOWABLE PEAK ON-STATE CURRENT vs. PULSE WIDTH ($di/dt = 200\text{A/usec}$)

FAST SWITCHING THYRISTORS