

## Dual Input Low Dropout Regulator

### Features

- **450mV Typ. Dropout at 3A in Dual Power Voltage Mode**
- **Remote Sense Pin Available**
- **2% Accuracy Over Temperature Range**
- **Build-in Over-Temperature Protection**
- **Build-in Current Limit**
- **5-Pin TO-220, TO-252, and TO-263 Packages**
- **Lead Free and Green Devices Available (RoHS Compliant)**

### Applications



- **Microprocessor Supplies**
- **Chip Set Supplies**
- **VGA Card Power**
- **LCD Monitor Power**

### General Description

The APL1582 of high performance positive voltage regulators are designed for using in applications requiring very low dropout voltage at 3Amps. The APL1582 can provide an output voltage at the range of 1.25V to 2.55V, where both 5V and 3.3V voltage supplies are available. The superior dropout characteristics result in reduced heat dissipation compared to regular LDOs. The APL1582 also provides excellent regulation over line, load, and temperature variations.

Current limit is trimmed to ensure specified output current and controlled short-circuit current. On-chip thermal limiting provides protection against any combination of overload that would create excessive junction temperature. The APL1582 is available in both the through-hole and surface mount versions of the industry standard 5-pin TO-220, TO-252, and TO-263 power packages.

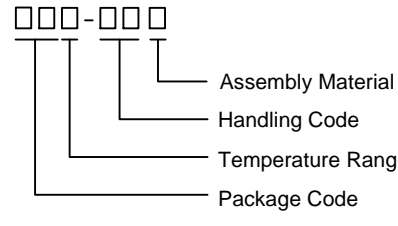
### Ordering and Marking Information

<p>APL1582 □□□-□□□</p>  <p>Assembly Material Handling Code Temperature Range Package Code</p>	<p>Package Code F5 : TO-220-5      G5: TO-263-5 U5 : TO-252-5 Operating Ambient Temperature Range C : 0 to 70 °C Handling Code TR : Tape &amp; Reel      TU : Tube Assembly Material G : Halogen and Lead Free Device</p>
<p>APL1582 F5/G5/U5 :</p> 	<p>XXXXX - Date Code</p>

Note: ANPEC lead-free products contain molding compounds/die attach materials and 100% matte tin plate termination finish; which are fully compliant with RoHS. ANPEC lead-free products meet or exceed the lead-free requirements of IPC/JEDEC J-STD-020C for MSL classification at lead-free peak reflow temperature. ANPEC defines "Green" to mean lead-free (RoHS compliant) and halogen free (Br or Cl does not exceed 900ppm by weight in homogeneous material and total of Br and Cl does not exceed 1500ppm by weight).

ANPEC reserves the right to make changes to improve reliability or manufacturability without notice, and advise customers to obtain the latest version of relevant information to verify before placing orders.

## Pin Configuration

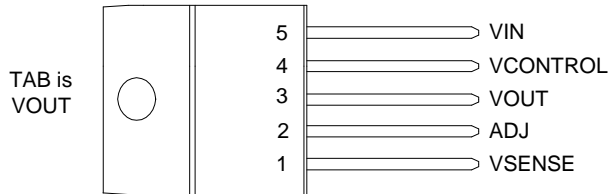

Top View of TO-220-5

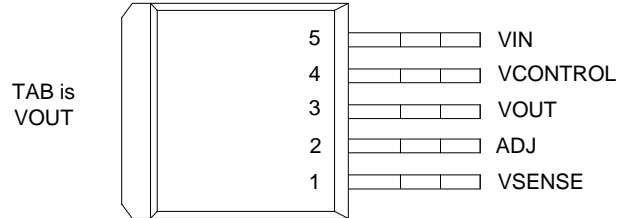

Top View of TO-252-5 / TO-263-5

## Absolute Maximum Ratings

Symbol	Parameter	Rating	Unit
$V_{IN}$	Input Voltage	7	V
$V_{CONTROL}$	Control Voltage	13.2	V
$\theta_{JA}$	Thermal Resistance – Junction to Ambient	62.5	°C / W
$P_D$	Power Dissipation	Internally Limited	W
$T_J$	Operating Junction Temperature	Control Section	0 to 125
		Power Transistor	0 to 150
$T_{STG}$	Storage Temperature Range	-65 to +150	°C
$T_L$	Maximum Lead Soldering Temperature, 10 Seconds	260	°C

## Electrical Characteristics

Unless otherwise noted these specifications apply over ,  $C_{IN}=1\mu F$  ,  $C_{OUT}=10\mu F$  ,  $T_J=0$  to  $125^\circ C$ . Typical values refer to  $T_J=25^\circ C$ .  
 $V_{OUT}=V_{SENSE}$

Symbol	Parameter	Test Conditions	APL1582			Unit
			Min.	Typ.	Max.	
$V_{REF}$	Reference Voltage	$V_{CONTROL}=2.75$ to $12V$ , $V_{IN}=2.05V$ to $5.5V$ , $I_O=10mA$ to $3A$ , $V_{ADJ}=0V$	1.225	1.250	1.275	V
$REG_{LINE}$	Line Regulation	$V_{CONTROL}=2.75V$ to $12V$ , $V_{IN}=1.75V$ to $5.5V$ , $I_O=10mA$ , $V_{ADJ}=0V$	-	-	3	mV
$REG_{LOAD}$	Load Regulation <sup>(Note 1)</sup>	$V_{CONTROL}=2.75V$ , $V_{IN}=2.1V$ , $I_O=10mA$ to $3A$ , $V_{ADJ}=0V$	-	-	5	mV
$V_{CONTROL}-V_{OUT}$	Dropout Voltage <sup>(Note 2)</sup>	$V_{IN}=2.05V$ , $I_O=3A$ , $V_{ADJ}=0V$	-	1.10	1.25	V
$V_{IN}-V_{OUT}$	Dropout Voltage <sup>(Note 2)</sup>	$V_{CONTROL}=2.75V$ , $I_O=3A$ , $V_{ADJ}=0V$	-	0.45	-	V
$I_{LIMIT}$	Current Limit	$V_{CONTROL}=2.75V$ , $V_{IN}=2.05V$	3.2	-	-	A
$I_{LMIN}$	Minimum Load Current <sup>(Note 3)</sup>	$V_{CONTROL}=5V$ , $V_{IN}=3.3V$ , $V_{ADJ}=0V$	-	5	10	mA

## Electrical Characteristics (Cont.)

Unless otherwise noted these specifications apply over ,  $C_{IN}=1\mu F$  ,  $C_{OUT}=10\mu F$  ,  $T_J=0$  to  $125^\circ C$ . Typical values refer to  $T_J=25^\circ C$ .

$$V_{OUT}=V_{SENSE}$$

Symbol	Parameter	Test Conditions	APL1582			Unit
			Min.	Typ.	Max.	
REG <sub>THERMAL</sub>	Thermal Regulation	30mS Pulse	-	0.01	-	%/W
PSRR	Power Supply Ripple Rejection	$T_J=25^\circ C$ , $V_{RIPPLE}=1V_{PP}$ at 120Hz, $V_{CONTROL}=5$ , $V_{IN}=5V$ , $I_O=3A$ , $V_{ADJ}=0V$	60	70	-	dB
I <sub>CONTROL</sub>	Control Pin Current	$V_{CONTROL}=2.75V$ , $V_{IN}=2.05V$ , $I_O=3A$ , $V_{ADJ}=0V$	-	33	120	mA
I <sub>ADJ</sub>	Adjust Pin Current	$V_{CONTROL}=2.75V$ , $V_{IN}=2.05V$ , $V_{ADJ}=0V$	-	50	120	$\mu A$

Note 1 : Low duty cycle pulse test with Kelvin connections are required to maintain data accuracy .

Note 2 : Drop-out voltage is defined as the minimum difference between VIN and VOUT required to maintain 1% VOUT regulation .

Note 3 : Minimum load current is defined as the minimum current required at the output to maintain VOUT regulation.

Typical Operating Characteristics

Reference Voltage vs. Junction Temperature

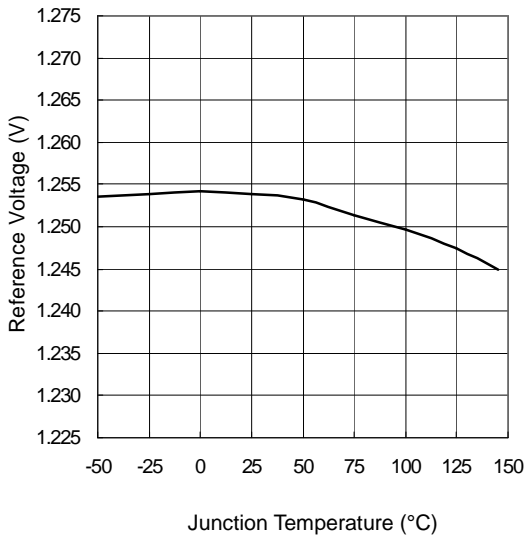

ADJ Pin Current vs. Junction Temperature

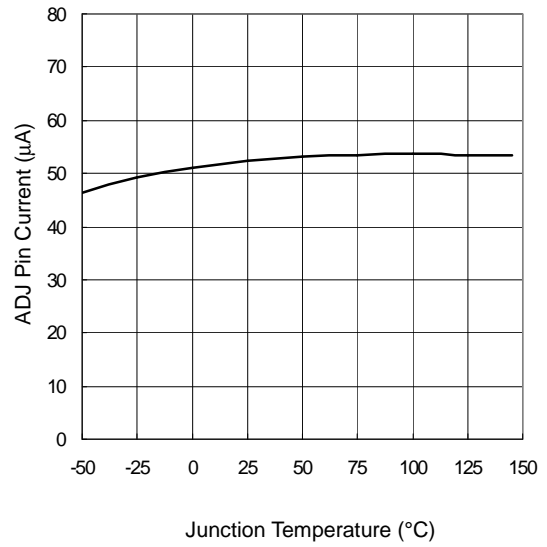

Minimum Load Current vs. Junction Temperature

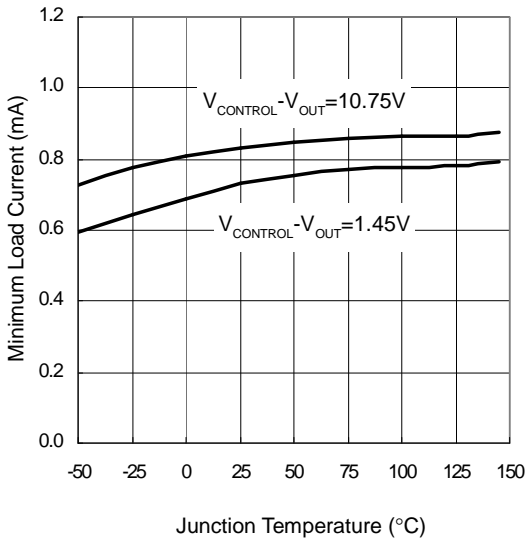

VIN-VOUT Dropout Voltage vs. Output Current

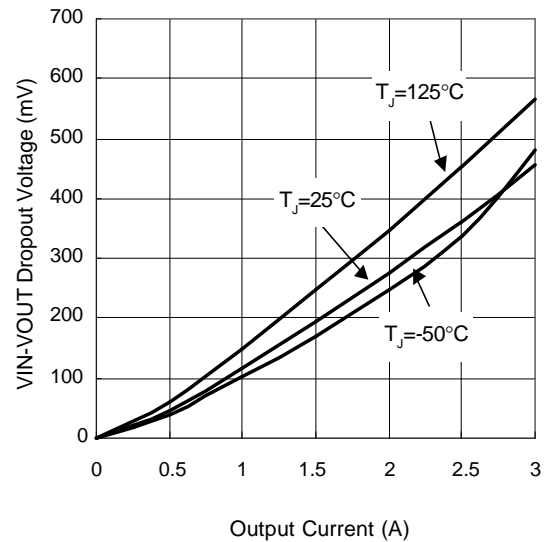

Typical Operating Characteristics (Cont.)

Short-Circuit Current vs. Junction Temperature

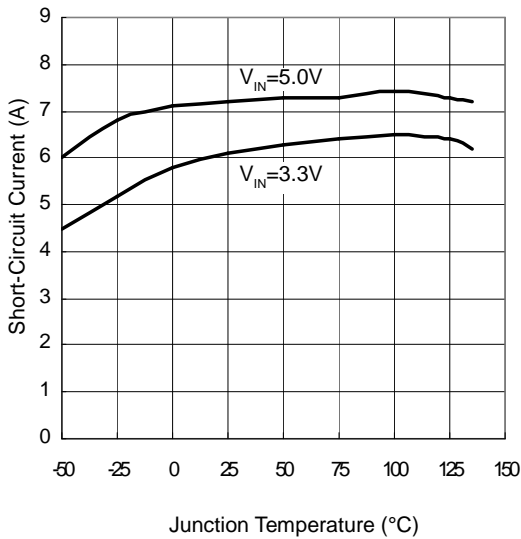

VCONTROL-VOUT Dropout Voltage vs. Output Current

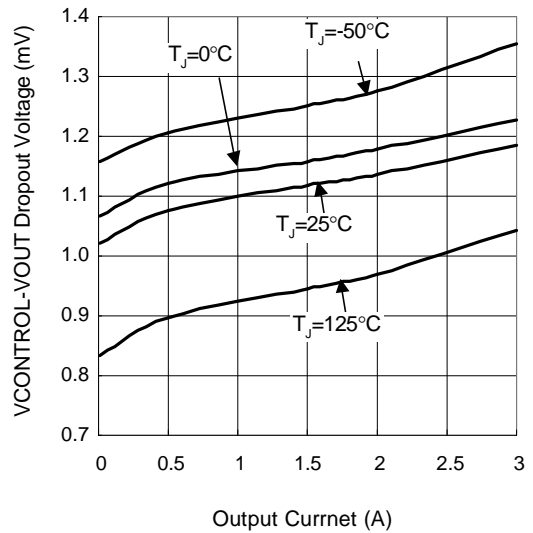

Control Pin Current vs. Output Current

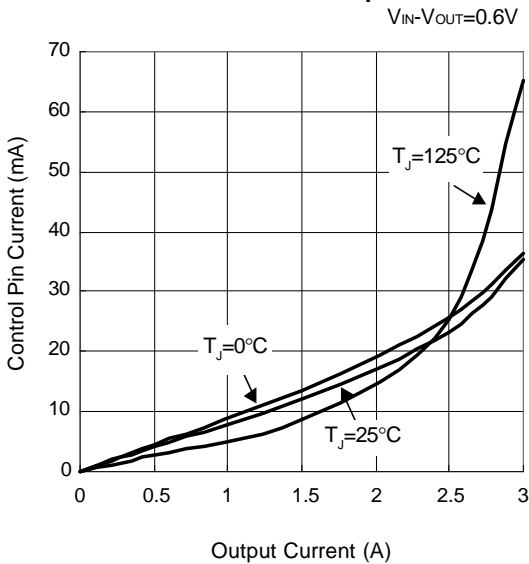

Control Pin Current vs. Output Current

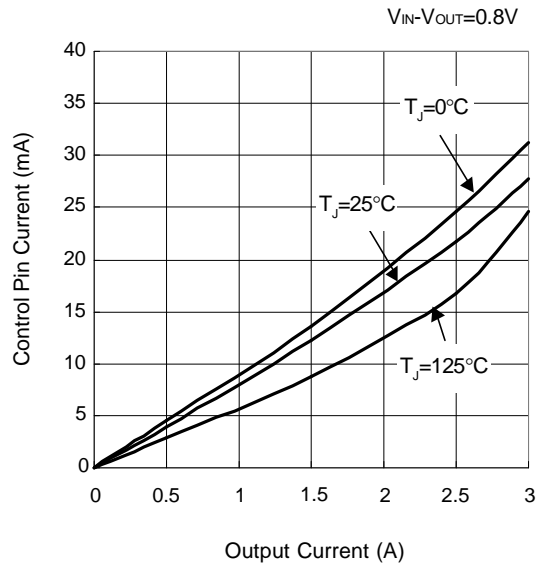

Typical Operating Characteristics (Cont.)

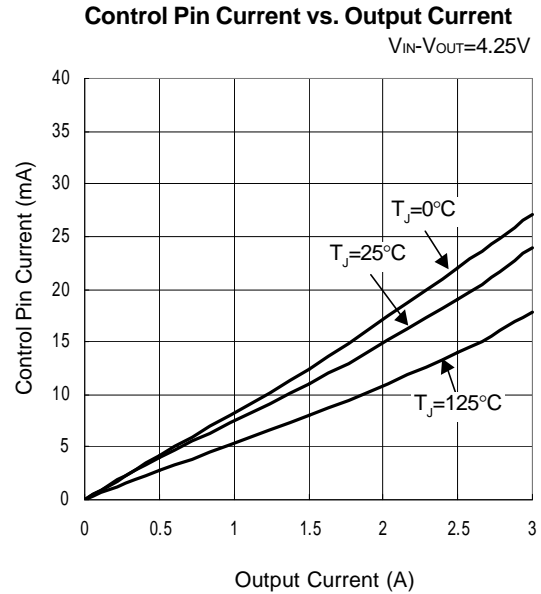
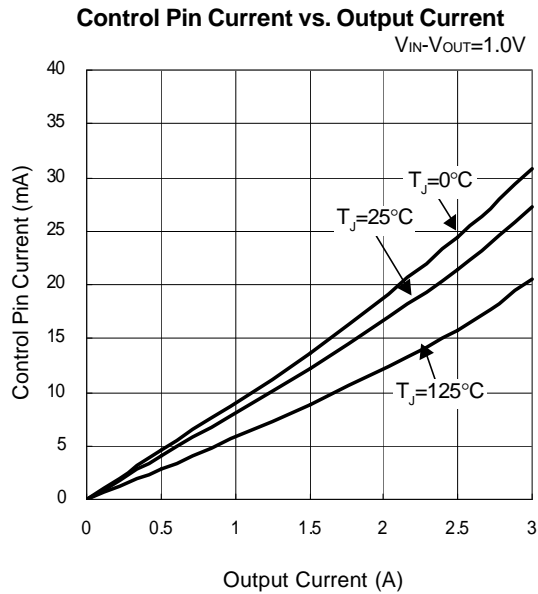

Pin Description

PIN		I/O	FUNCTION
NO.	NAME		
1	VSENSE	I	Positive side of the reference voltage, which allows remote sensing to obtain excellent load regulation.
2	ADJ	O	Negative side of the reference voltage, which allows to use resistor divider to set an expect output voltage. A small bypass capacitor can be connected from this pin to ground to improve PSRR performance.
3	VOUT	O	Output pin of the regulator, which connects to the TAB. A minimum of 10μF capacitor must be connected from this pin to ground to ensure the stability.
4	VCONTROL	I	Supply pin of the control circuitry, which must be always higher than VOUT for the device to regulate. (See Electrical Characteristics)
5	VIN	I	Power input pin of the regulator, which must be always higher than VOUT for the device to regulate. (See Electrical Characteristics)

Block Diagram

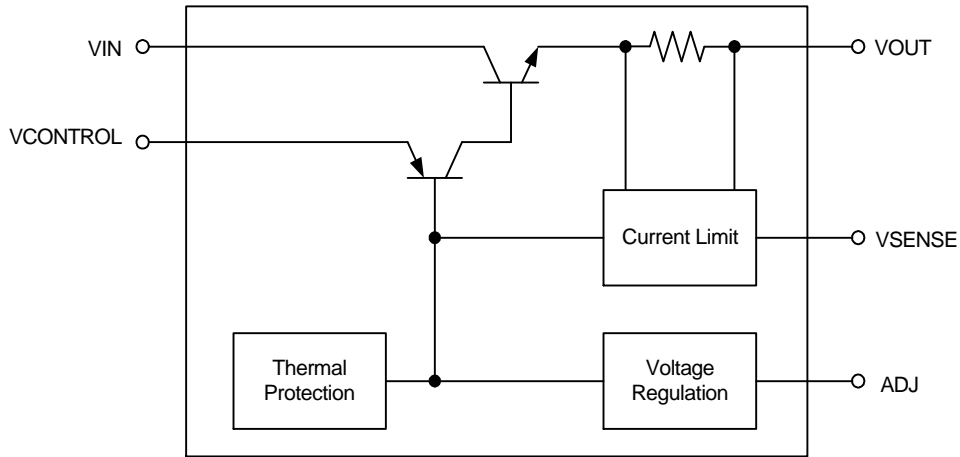

Typical Application Circuit

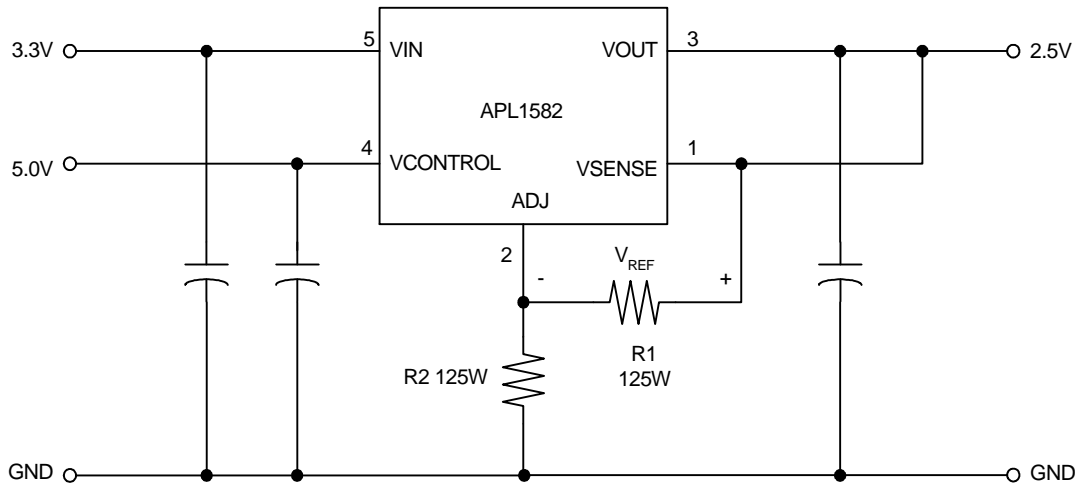

$$* V_{OUT} = V_{REF} ( 1 + R2 / R1 ) + I_{ADJ} * R2$$

\* R1 is typically in range of 100Ω to 125Ω to satisfy the minimum load current requirement

Package Information

TO-220-5

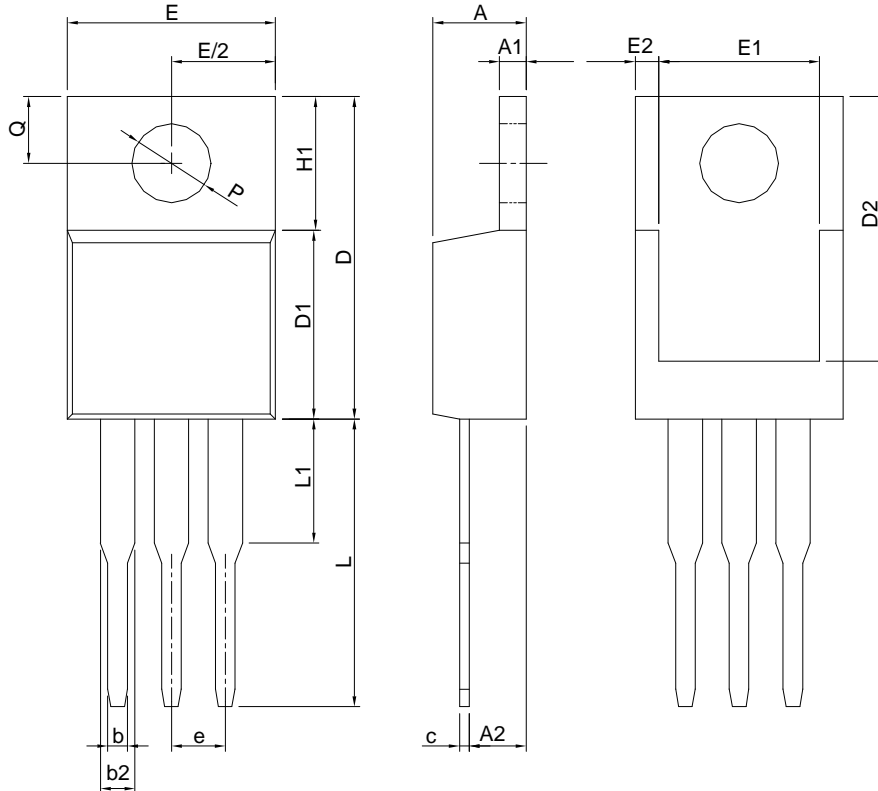

DIMENSIONS	TO-220-5			
	MILLIMETERS		INCHES	
	MIN.	MAX.	MIN.	MAX.
A	3.56	4.83	0.140	0.190
A1	0.51	1.40	0.020	0.055
A2	2.03	2.92	0.080	0.115
b	0.38	1.02	0.015	0.040
b2	1.14	1.78	0.045	0.070
c	0.36	0.61	0.014	0.024
D	14.22	16.51	0.560	0.650
D1	8.38	9.02	0.330	0.355
D2	12.19	12.88	0.480	0.507
E	9.65	10.67	0.380	0.420
E1	6.86	8.89	0.270	0.350
E2		0.76		0.030
e	2.54 BSC		0.100 BSC	
H1	5.84	6.86	0.230	0.270
L	12.70	14.73	0.500	0.580
L1		6.35		0.250
P	3.53	4.09	0.139	0.161
Q	2.54	3.43	0.100	0.135

Note: Follow JEDEC TO-220 AB.



Package Information

TO-252-5

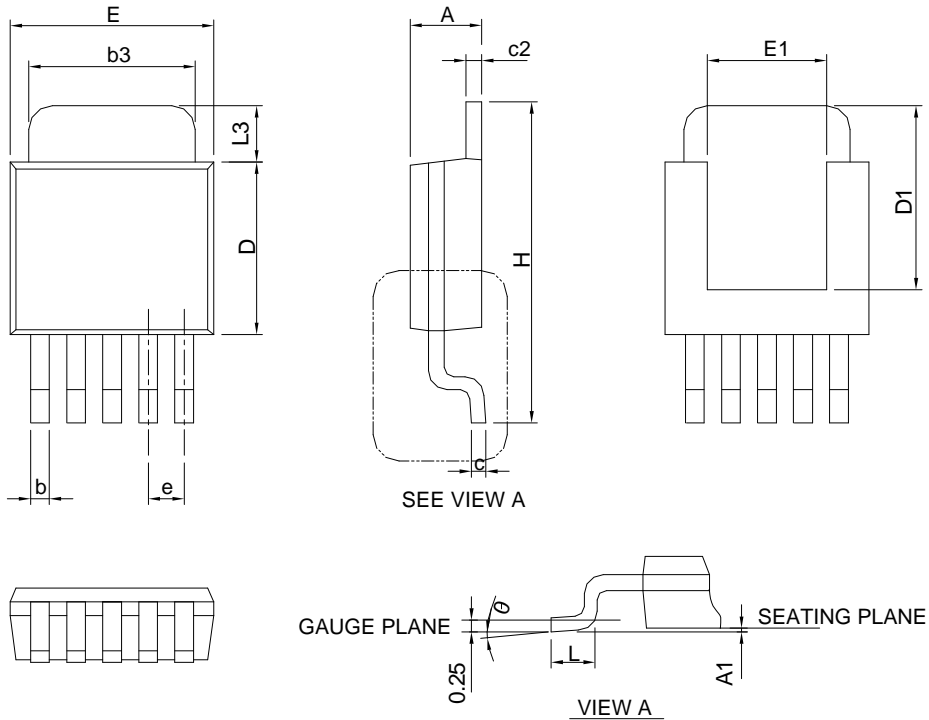

SYMBOL	TO-252-5			
	MILLIMETERS		INCHES	
	MIN.	MAX.	MIN.	MAX.
A	2.18	2.39	0.086	0.094
A1		0.13		0.005
b	0.50	0.89	0.020	0.035
b3	4.32	5.46	0.170	0.215
c	0.46	0.61	0.018	0.024
c2	0.46	0.89	0.018	0.035
D	5.33	6.22	0.210	0.245
D1	4.57	6.00	0.180	0.236
E	6.35	6.73	0.250	0.265
E1	3.81	6.00	0.150	0.236
e	1.27 BSC		0.050 BSC	
H	9.40	10.41	0.370	0.410
L	1.40	1.78	0.055	0.070
L3	0.89	2.03	0.035	0.080
$\theta$	0°	8°	0°	8°

Package Information

TO-263-5

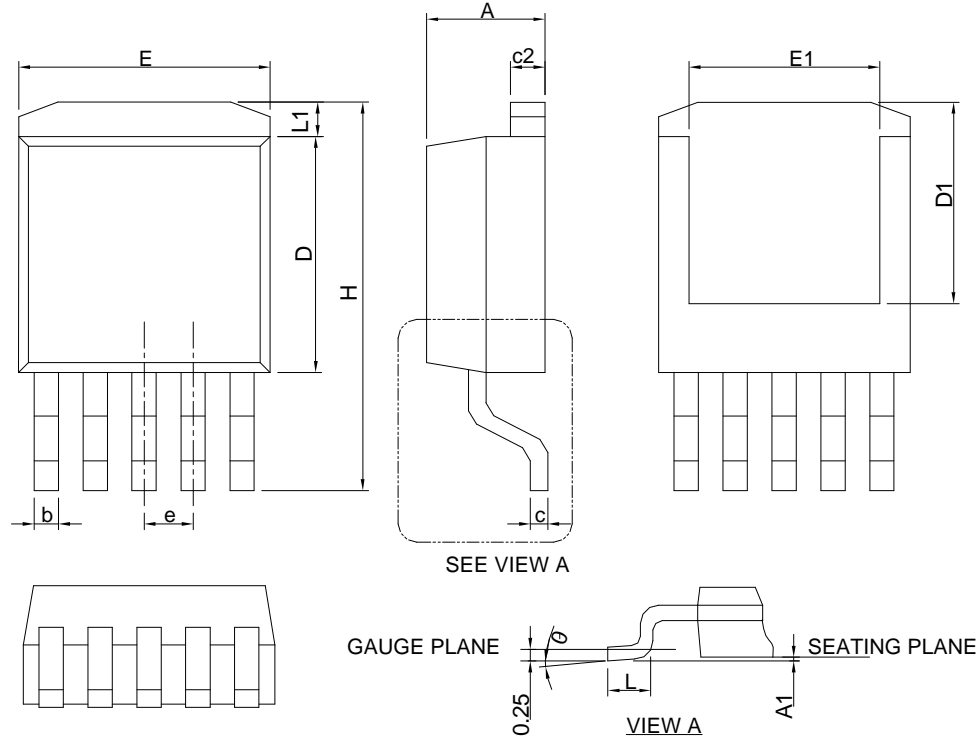

SYMBOL	TO-263-5			
	MILLIMETERS		INCHES	
	MIN.	MAX.	MIN.	MAX.
A	4.06	4.83	0.160	0.190
A1	0.00	0.25	0.000	0.010
b	0.51	0.99	0.020	0.039
c	0.38	0.74	0.015	0.029
c2	1.14	1.65	0.045	0.065
D	8.38	9.65	0.330	0.380
D1	6.00	9.00	0.236	0.354
E	9.65	11.43	0.380	0.450
E1	6.22	9.00	0.245	0.354
e	1.70 BSC		0.067 BSC	
H	14.61	15.88	0.575	0.625
L	1.78	2.79	0.070	0.110
L1		1.68		0.066
θ	0°	8°	0°	8°

Note : Follow JEDEC TO-263 BB.

### Carrier Tape & Reel Dimensions

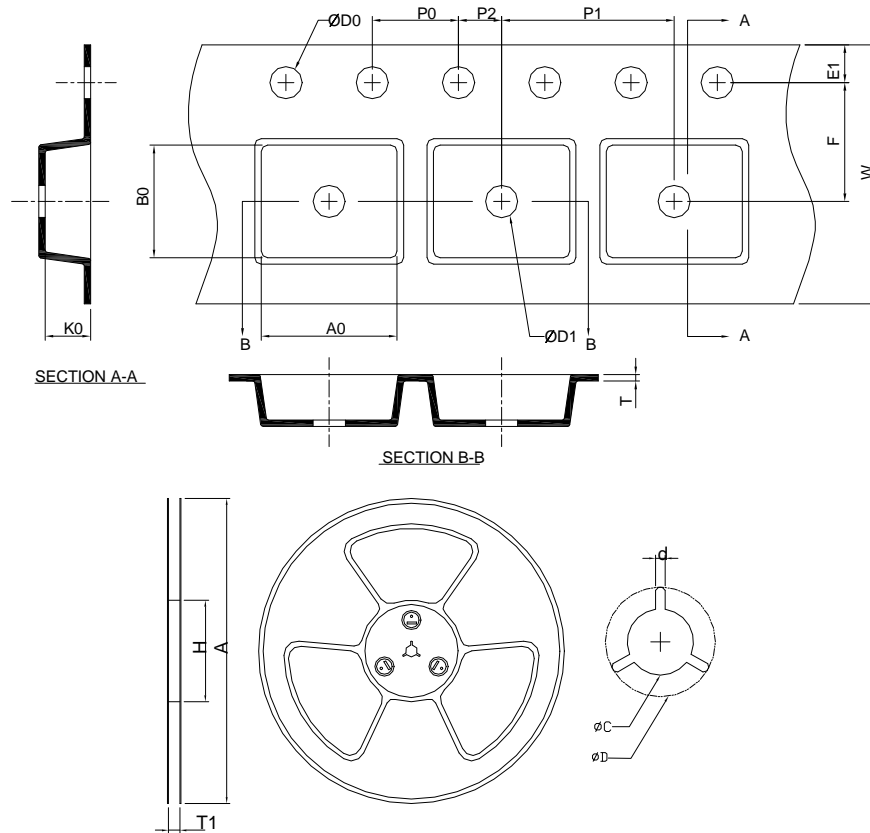

Application	A	H	T1	C	d	D	W	E1	F
TO-252	330.0 ±0.00	50 MIN.	16.4+2.00 -0.00	13.0+0.50 -0.20	1.5 MIN.	20.2 MIN.	16.0 ±0.30	1.75 ±0.10	7.50 ±0.05
	P0	P1	P2	D0	D1	T	A0	B0	K0
	4.0 ±0.10	8.0 ±0.10	2.0 ±0.05	1.5+0.10 -0.00	1.5 MIN.	0.6+0.00 -0.40	6.80 ±0.20	10.40 ±0.20	2.50 ±0.20
Application	A	H	T1	C	d	D	W	E1	F
TO-263	330.0 ±0.00	50 MIN.	24.4+2.00 -0.00	13.0+0.50 -0.20	1.5 MIN.	20.2 MIN.	24.0 ±0.30	1.75 ±0.10	11.5 ±0.10
	P0	P1	P2	D0	D1	T	A0	B0	K0
	4.0 ±0.10	16.0 ±0.10	2.0 ±0.10	1.5+0.10 -0.00	1.5 MIN.	0.6+0.00 -0.40	10.8 ±0.20	16.1 ±0.20	5.2 ±0.20

### Devices Per Unit

Package Type	Unit	Quantity
TO-252-5	Tape & Reel	2500
TO-263-5	Tape & Reel	1000

### Taping Direction Information

TO-252-5

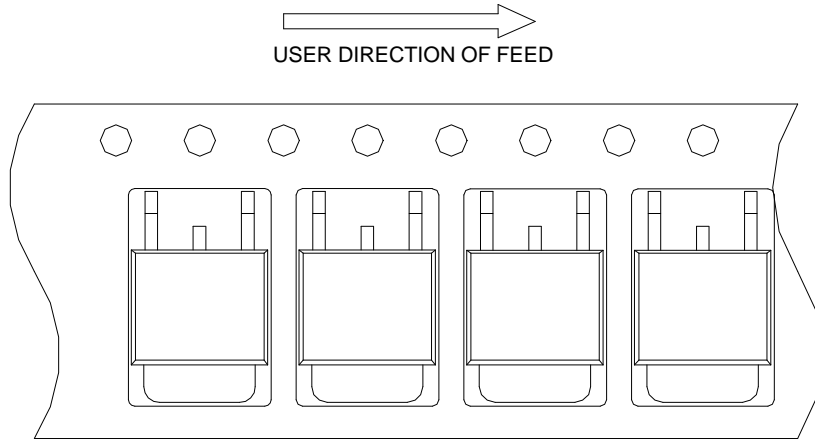

TO-263-5

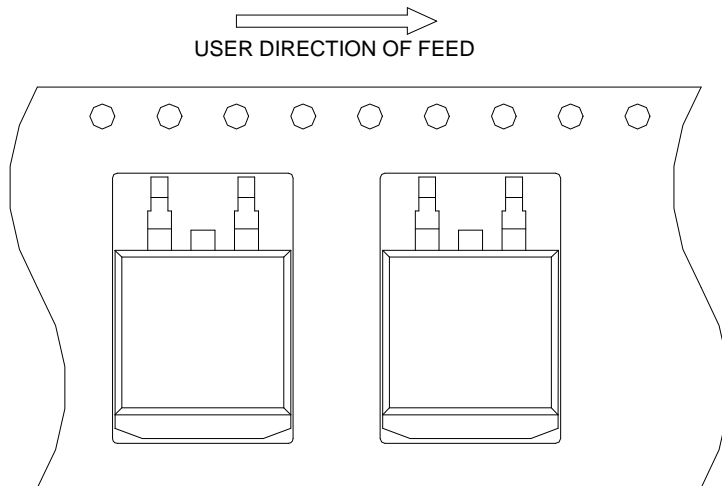

**Reflow Condition (IR/Convection or VPR Reflow)**

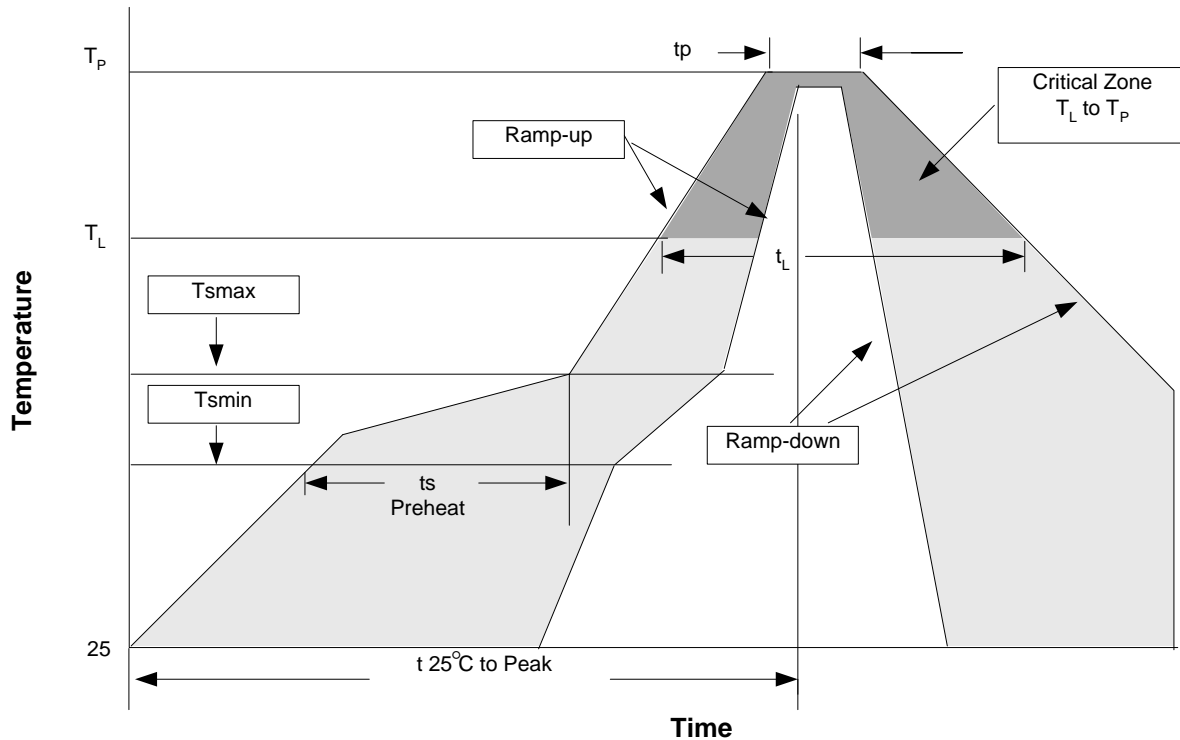

**Reliability Test Program**

Test item	Method	Description
SOLDERABILITY	MIL-STD-883D-2003	245°C, 5 sec
HOLT	MIL-STD-883D-1005.7	1000 Hrs Bias @125°C
PCT	JESD-22-B,A102	168 Hrs, 100%RH, 121°C
TST	MIL-STD-883D-1011.9	-65°C~150°C, 200 Cycles
ESD	MIL-STD-883D-3015.7	VHBM > 2KV, VMM > 200V
Latch-Up	JESD 78	10ms, 1 <sub>tr</sub> > 100mA

**Classification Reflow Profiles**

Profile Feature	Sn-Pb Eutectic Assembly	Pb-Free Assembly
Average ramp-up rate (T <sub>L</sub> to T <sub>p</sub> )	3°C/second max.	3°C/second max.
Preheat		
- Temperature Min (T <sub>smmin</sub> )	100°C	150°C
- Temperature Max (T <sub>smmax</sub> )	150°C	200°C
- Time (min to max) (t <sub>s</sub> )	60-120 seconds	60-180 seconds
Time maintained above:		
- Temperature (T <sub>L</sub> )	183°C	217°C
- Time (t <sub>L</sub> )	60-150 seconds	60-150 seconds
Peak/Classification Temperature (T <sub>p</sub> )	See table 1	See table 2
Time within 5°C of actual Peak Temperature (t <sub>p</sub> )	10-30 seconds	20-40 seconds
Ramp-down Rate	6°C/second max.	6°C/second max.
Time 25°C to Peak Temperature	6 minutes max.	8 minutes max.

Notes: All temperatures refer to topside of the package. Measured on the body surface.

**Classification Reflow Profiles (Cont.)**

Table 1. SnPb Eutectic Process – Package Peak Reflow Temperatures

Package Thickness	Volume mm <sup>3</sup> <350	Volume mm <sup>3</sup> ≥350
<2.5 mm	240 +0/-5°C	225 +0/-5°C
≥2.5 mm	225 +0/-5°C	225 +0/-5°C

Table 2. Pb-free Process – Package Classification Reflow Temperatures

Package Thickness	Volume mm <sup>3</sup> <350	Volume mm <sup>3</sup> 350-2000	Volume mm <sup>3</sup> >2000
<1.6 mm	260 +0°C*	260 +0°C*	260 +0°C*
1.6 mm – 2.5 mm	260 +0°C*	250 +0°C*	245 +0°C*
≥2.5 mm	250 +0°C*	245 +0°C*	245 +0°C*

\*Tolerance: The device manufacturer/supplier **shall** assure process compatibility up to and including the stated classification temperature (this means Peak reflow temperature +0°C. For example 260°C+0°C) at the rated MSL level.

**Customer Service**

**Anpec Electronics Corp.**

Head Office :

No.6, Dusing 1st Road, SBIP,

Hsin-Chu, Taiwan, R.O.C.

Tel : 886-3-5642000

Fax : 886-3-5642050

Taipei Branch :

2F, No. 11, Lane 218, Sec 2 Jhongsing Rd.,

Sindian City, Taipei County 23146, Taiwan, R. O. C.

Tel : 886-2-2910-3838

Fax : 886-2-2917-3838