

KSA1943

Audio Power Amplifier

- High Current Capability $I_C = -13A$
- High Power Dissipation
- Wide S.O.A
- Complement to KSC5200

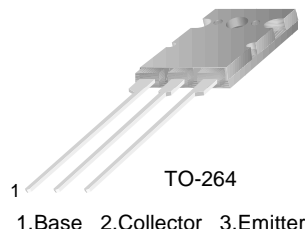

PNP Epitaxial Silicon Transistor

Absolute Maximum Ratings $T_C=25^\circ C$ unless otherwise noted

Symbol	Parameter	Ratings	Units
V_{CBO}	Collector-Base Voltage	-230	V
V_{CEO}	Collector-Emitter Voltage	-230	V
V_{EBO}	Emitter-Base Voltage	-5	V
I_C	Collector Current	-13	A
I_B	Base Current	-1.5	A
P_C	Collector Dissipation ($T_C=25^\circ C$)	130	W
T_J	Junction Temperature	150	$^\circ C$
T_{STG}	Storage Temperature	- 50 ~ 150	$^\circ C$

Electrical Characteristics $T_C=25^\circ C$ unless otherwise noted

Symbol	Parameter	Test Condition	Min.	Typ.	Max.	Units
BV_{CBO}	Collector-Base Breakdown Voltage	$I_C=-5mA, I_E=0$	-230			V
BV_{CEO}	Collector-Emitter Breakdown Voltage	$I_C=-10mA, R_{BE}=\infty$	-230			V
BV_{EBO}	Emitter-Base Breakdown Voltage	$I_E=-5mA, I_C=0$	-5			V
I_{CBO}	Collector Cut-off Current	$V_{CB}=-230V, I_E=0$			-5.0	μA
I_{EBO}	Emitter Cut-off Current	$V_{EB}=-5V, I_C=0$			-5.0	μA
h_{FE1}	* DC Current Gain	$V_{CE}=-5V, I_C=-1A$	55		160	
h_{FE2}	DC Current Gain	$V_{CE}=-5V, I_C=-7A$	35	60		
$V_{CE(sat)}$	Collector-Emitter Saturation Voltage	$I_C=-8A, I_B=-0.8A$		-0.4	-3.0	V
$V_{BE(on)}$	Base-Emitter ON Voltage	$V_{CE}=-5V, I_C=-7A$		-1.0	-1.5	V
f_T	Current Gain Bandwidth Product	$V_{CE}=-5V, I_C=-1A$		30		MHz
C_{ob}	Output Capacitance	$V_{CB}=-10V, f=1MHz$		360		pF

* Pulse Test : PW=20us

* h_{FE} Classification

Classification	R	O
h_{FE1}	55 ~ 110	80 ~ 160

Typical Characteristics

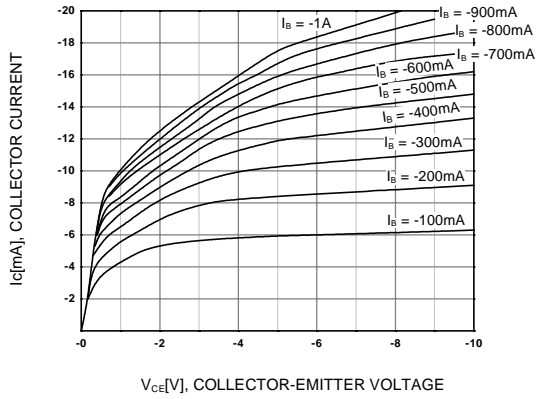

Figure 1. Static Characteristic

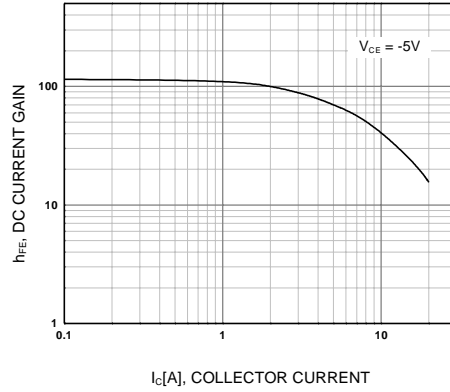

Figure 2. DC current Gain

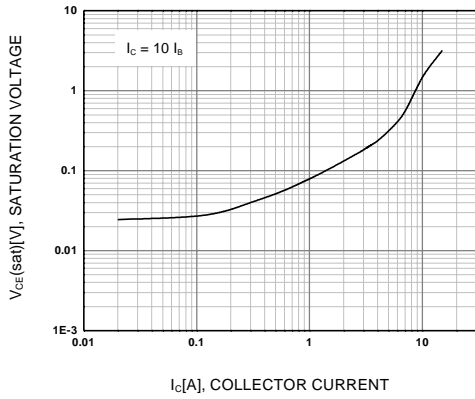

Figure 3. Collector-Emitter Saturation Voltage

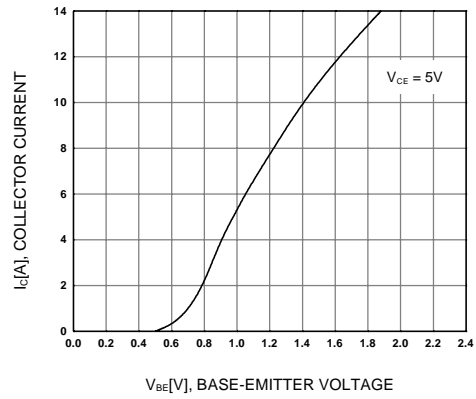

Figure 4. Collector-Emitter Saturation Voltage

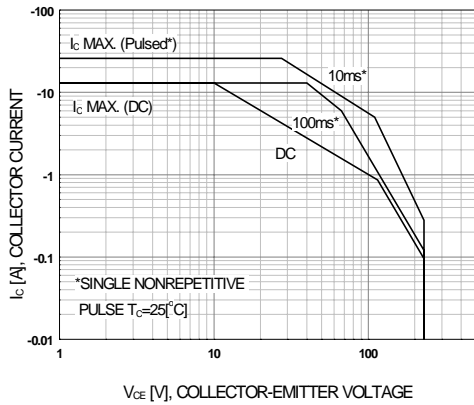

Figure 5. Safe Operating Area

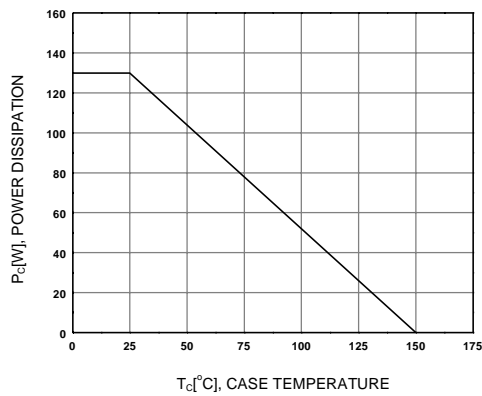
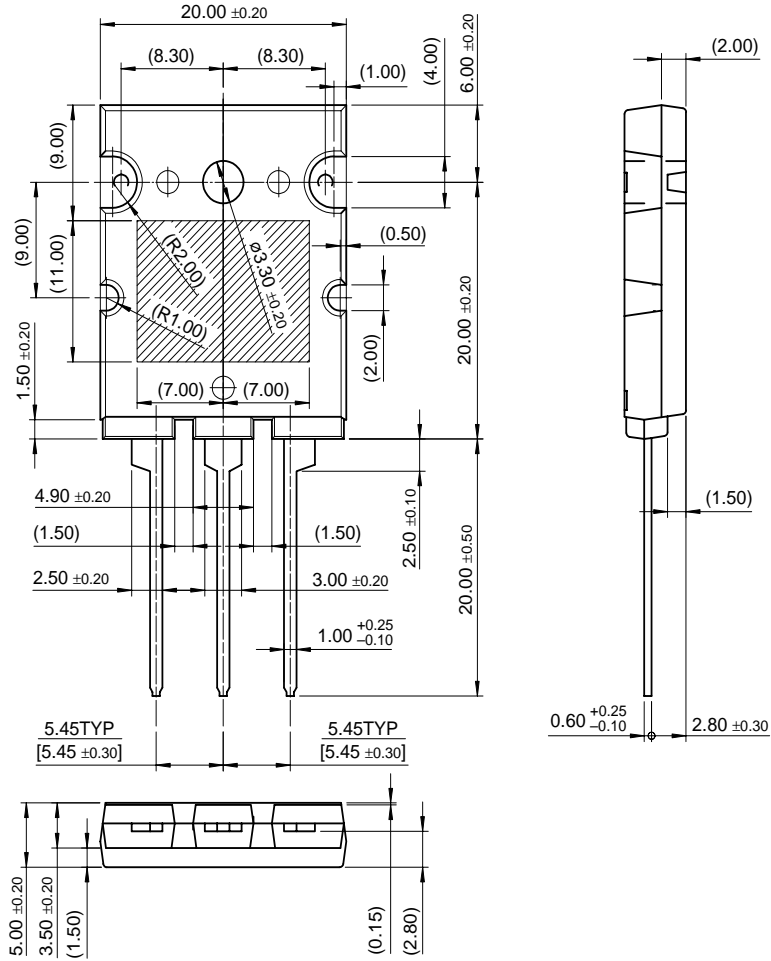

Figure 6. Power Derating

Package Dimensions

TO-264



Dimensions in Millimeters

TRADEMARKS

The following are registered and unregistered trademarks Fairchild Semiconductor owns or is authorized to use and is not intended to be an exhaustive list of all such trademarks.

ACE _x TM	FAST [®]	OPTOLOGIC TM	SMART START TM	VCX TM
Bottomless TM	FAST _r TM	OPTOPLANAR TM	STAR*POWER TM	
CoolFET TM	FRFET TM	PACMAN TM	Stealth TM	
CROSSVOLT TM	GlobalOptoisolator TM	POP TM	SuperSOT TM -3	
DenseTrench TM	GTO TM	Power247 TM	SuperSOT TM -6	
DOMET TM	HiSeC TM	PowerTrench [®]	SuperSOT TM -8	
EcoSPARK TM	ISOPLANAR TM	QFET TM	SyncFET TM	
E ² CMOS TM	LittleFET TM	QS TM	TruTranslation TM	
EnSigna TM	MicroFET TM	QT Optoelectronics TM	TinyLogic TM	
FACT TM	MicroPak TM	Quiet Series TM	UHC TM	
FACT Quiet Series TM	MICROWIRE TM	SLIENT SWITCHER [®]	UltraFET [®]	

STAR*POWER is used under license

DISCLAIMER

FAIRCHILD SEMICONDUCTOR RESERVES THE RIGHT TO MAKE CHANGES WITHOUT FURTHER NOTICE TO ANY PRODUCTS HEREIN TO IMPROVE RELIABILITY, FUNCTION OR DESIGN. FAIRCHILD DOES NOT ASSUME ANY LIABILITY ARISING OUT OF THE APPLICATION OR USE OF ANY PRODUCT OR CIRCUIT DESCRIBED HEREIN; NEITHER DOES IT CONVEY ANY LICENSE UNDER ITS PATENT RIGHTS, NOR THE RIGHTS OF OTHERS.

LIFE SUPPORT POLICY

FAIRCHILD'S PRODUCTS ARE NOT AUTHORIZED FOR USE AS CRITICAL COMPONENTS IN LIFE SUPPORT DEVICES OR SYSTEMS WITHOUT THE EXPRESS WRITTEN APPROVAL OF FAIRCHILD SEMICONDUCTOR CORPORATION.

As used herein:

1. Life support devices or systems are devices or systems which, (a) are intended for surgical implant into the body, or (b) support or sustain life, or (c) whose failure to perform when properly used in accordance with instructions for use provided in the labeling, can be reasonably expected to result in significant injury to the user.
2. A critical component is any component of a life support device or system whose failure to perform can be reasonably expected to cause the failure of the life support device or system, or to affect its safety or effectiveness.

PRODUCT STATUS DEFINITIONS

Definition of Terms

Datasheet Identification	Product Status	Definition
Advance Information	Formative or In Design	This datasheet contains the design specifications for product development. Specifications may change in any manner without notice.
Preliminary	First Production	This datasheet contains preliminary data, and supplementary data will be published at a later date. Fairchild Semiconductor reserves the right to make changes at any time without notice in order to improve design.
No Identification Needed	Full Production	This datasheet contains final specifications. Fairchild Semiconductor reserves the right to make changes at any time without notice in order to improve design.
Obsolete	Not In Production	This datasheet contains specifications on a product that has been discontinued by Fairchild semiconductor. The datasheet is printed for reference information only.

Fairchild Semiconductor

SEARCH | [Parametric](#) | [Cross Reference](#)

space

Product Folders and

Applies

find products

[Home](#) >> [Find products](#) >>[Products groups](#)[Analog and Mixed](#)[Signal](#)[Discrete](#)[Interface](#)[Logic](#)[Microcontrollers](#)[Non-Volatile](#)[Memory](#)[Optoelectronics](#)[Markets and applications](#)[New products](#)[Product selection and parametric search](#)[Cross-reference search](#)

KSA1943

PNP Epitaxial Silicon Transistor

[Contents](#)[Features](#) | [Product status/pricing/packaging](#) |[Models](#)

Features

Audio Power Amplifier

- High Current Capability: $I_C = -13A$
- High Power Dissipation
- Wide S.O.A.
- Complement to KSC5200

Datasheet

[Download this datasheet](#)

PDF

[e-mail this datasheet](#)

[E-]

This page

[Print version](#)[Related Links](#)[Request samples](#)[Dotted line](#)[How to order products](#)[Dotted line](#)[Product Change Notices](#)[\(PCNs\)](#)[Dotted line](#)[Support](#)[Dotted line](#)[Distributor and field sales representatives](#)[Dotted line](#)[Quality and reliability](#)[Dotted line](#)[Design tools](#)

technical information

buy products

technical support

my Fairchild

company

[back to top](#)

Product status/pricing/packaging

Product	Product status	Pricing*	Package type	Leads	Packing method
KSA1943OTU	Full Production	\$1.79	TO-264	3	RAIL
KSA1943RTU	Full Production	\$1.79	TO-264	3	RAIL

* 1,000 piece Budgetary Pricing

[back to top](#)

Models

Package & leads	Condition	Temperature range	Software version	Revision date
PSPICE				
TO-264-3	Electrical/Thermal	-25°C to 100°C	9	Mar 17, 2000

[back to top](#)

[Home](#) | [Find products](#) | [Technical information](#) | [Buy products](#) |
[Support](#) | [Company](#) | [Contact us](#) | [Site index](#) | [Privacy policy](#)

[© Copyright 2002 Fairchild Semiconductor](#)
