



Package: AIN Leadless Chip Carrier / S08



Features

- Advanced GaN HEMT Technology
- Output Power of 9W
- Advanced Heat-Sink Technology
- 225MHz to 1215MHz Instantaneous Bandwidth
- Input Internally Matched to 50Ω
- 28V Operation Typical Performance
 - Output Power 39.5dBm
 - Gain 16dB
 - Power Added Efficiency 60%
- -40°C to 85°C Operating Temperature
- Large Signal Models Available

Applications

- Class AB Operation for Public Mobile Radio
- Power Amplifier Stage for Commercial Wireless Infrastructure
- General Purpose Tx Amplification
- Test Instrumentation
- Civilian and Military Radar

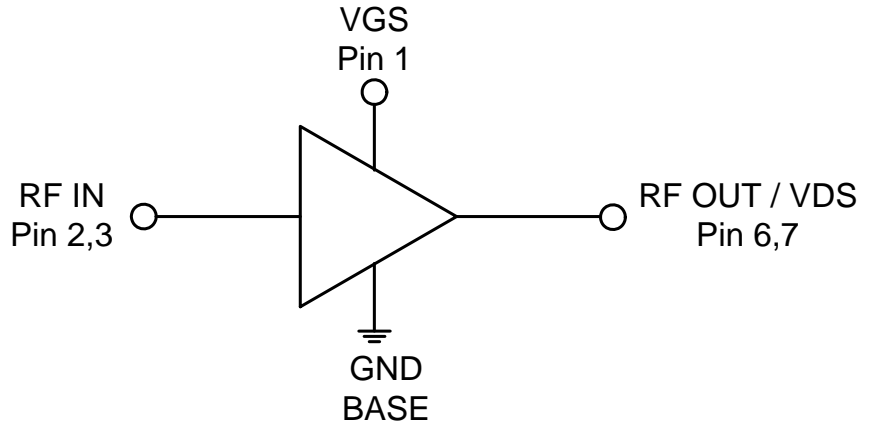

Functional Block Diagram

Product Description

The RFHA1006 is a wideband Power Amplifier designed for CW and pulsed applications such as wireless infrastructure, RADAR, two way radios and general purpose amplification. Using an advanced high power density Gallium Nitride (GaN) semiconductor process, these high-performance amplifiers achieve high efficiency, flat gain, and large instantaneous bandwidth in a single amplifier design. The RFHA1006 is an input matched GaN transistor packaged in an air cavity ceramic package which provides excellent thermal stability through the use of advanced heat sink and power dissipation technologies. Ease of integration is accomplished through the incorporation of optimized input matching network within the package that provides wideband gain and power performance in a single amplifier. An external output match offers the flexibility of further optimizing power and efficiency for any sub-band within the overall bandwidth.

Ordering Information

RFHA1006S2	2-Piece sample bag
RFHA1006SB	5-Piece bag
RFHA1006SQ	25-Piece bag
RFHA1006SR	100 Pieces on 7" short reel
RFHA1006TR7	750 Pieces on 7" reel
RFHA1006PCBA-410	Fully assembled evaluation board 225MHz to 1215MHz; 28V operation

Optimum Technology Matching® Applied

- | | | | |
|--------------------------------------|--------------------------------------|-------------------------------------|--|
| <input type="checkbox"/> GaAs HBT | <input type="checkbox"/> SiGe BiCMOS | <input type="checkbox"/> GaAs pHEMT | <input checked="" type="checkbox"/> GaN HEMT |
| <input type="checkbox"/> GaAs MESFET | <input type="checkbox"/> Si BiCMOS | <input type="checkbox"/> Si CMOS | <input type="checkbox"/> BiFET HBT |
| <input type="checkbox"/> InGaP HBT | <input type="checkbox"/> SiGe HBT | <input type="checkbox"/> Si BJT | |

RF MICRO DEVICES®, RFMD®, Optimum Technology Matching®, Enabling Wireless Connectivity™, PowerStar®, POLARIS™ TOTAL RADIO™ and UltimateBlue™ are trademarks of RFMD, LLC. BLUETOOTH is a trademark owned by Bluetooth SIG, Inc., U.S.A. and licensed for use by RFMD. All other trade names, trademarks and registered trademarks are the property of their respective owners. ©2012, RF Micro Devices, Inc.

Absolute Maximum Ratings

Parameter	Rating	Unit
Drain Voltage (V_D)	150	V
Gate Voltage (V_G)	-8 to +2	V
Gate Current (I_G)	10	mA
Operational Voltage	32	V
RF- Input Power	30	dBm
Ruggedness (VSWR)	12:1	
Storage Temperature Range	-55 to +125	°C
Operating Temperature Range (T_L)	-40 to +85	°C
Operating Junction Temperature (T_J)	200	°C
Human Body Model	Class 1A	
MTTF ($T_J < 200^\circ\text{C}$, 95% Confidence Limits)*	3×10^6	Hours
Thermal Resistance, R_{TH} (junction to case) measured at $T_C = 85^\circ\text{C}$, DC bias only	6	°C/W



Caution! ESD sensitive device.

Exceeding any one or a combination of the Absolute Maximum Rating conditions may cause permanent damage to the device. Extended application of Absolute Maximum Rating conditions to the device may reduce device reliability. Specified typical performance or functional operation of the device under Absolute Maximum Rating conditions is not implied.

The information in this publication is believed to be accurate and reliable. However, no responsibility is assumed by RF Micro Devices, Inc. ("RFMD") for its use, nor for any infringement of patents, or other rights of third parties, resulting from its use. No license is granted by implication or otherwise under any patent or patent rights of RFMD. RFMD reserves the right to change component circuitry, recommended application circuitry and specifications at any time without prior notice.



RoHS (Restriction of Hazardous Substances): Compliant per EU Directive 2002/95/EC.

* MTTF - median time to failure for wear-out failure mode (30% I_{DSS} degradation) which is determined by the technology process reliability.

Refer to product qualification report for FIT(random) failure rate.

Operation of this device beyond any one of these limits may cause permanent damage. For reliable continuous operation, the device voltage and current must not exceed the maximum operating values.

Bias Conditions should also satisfy the following expression: $P_{DISS} < (T_J - T_C)/R_{TH} J - C$ and $T_C = T_{CASE}$

Parameter	Specification			Unit	Condition
	Min.	Typ.	Max.		
Recommended Operating Conditions					
Drain Voltage (V_{DSQ})		28	32	V	
Gate Voltage (V_{GSQ})	-5	-3	-2	V	
Drain Bias Current		88		mA	
RF Input Power (P_{IN})			28	dBm	
Input Source VSWR			10:1		
RF Performance Characteristics					
Frequency Range	225		1215	MHz	Small signal 3dB bandwidth
Linear Gain		16		dB	$P_{OUT} = 30\text{dBm}$
Power Gain		14		dB	$P_{OUT} = 39.5\text{dBm}$
Gain Flatness		3		dB	$P_{OUT} = 30\text{dBm}$, 225MHz to 1215MHz
Gain Variation with Temperature		-0.02		dB/°C	
Input Return Loss (S_{11})			-11	dB	
Output Power		39.5		dBm	225MHz to 1215MHz
Power Added Efficiency (PAE)		60		%	225MHz to 1215MHz

Parameter	Specification			Unit	Condition
	Min.	Typ.	Max.		
RF Functional Tests					[1], [2]
$V_{GS(Q)}$		-3.2		V	
Gain		16.6		dB	$P_{IN} = 10\text{dBm}$, 300MHz
Power Gain	14.8	15.4		dB	$P_{IN} = 24\text{dBm}$, 300MHz
Input Return Loss			-10	dB	
Output Power		39.4		dBm	
Power Added Efficiency (PAE)	55	62.5		%	
Gain		15		dB	$P_{IN} = 10\text{dBm}$, 1100MHz
Power Gain	14	14.5		dB	$P_{IN} = 25\text{dBm}$, 1100MHz
Input Return Loss			-9	dB	
Output Power		39.5		dBm	
Power Added Efficiency (PAE)	48	53		%	

[1] Test Conditions: $V_{DSQ} = 28\text{V}$, $I_{DQ} = 88\text{mA}$, CW, $T = 25^\circ\text{C}$.

[2] Performance in a standard tuned test fixture.

Typical Performance in Standard Fixed Tuned Test Fixture Matched for 225MHz to 1215MHz (T = 25 °C, unless noted)

Small Signal s-parameters versus Frequency
($V_D = 28V, I_{DQ} = 88mA$)

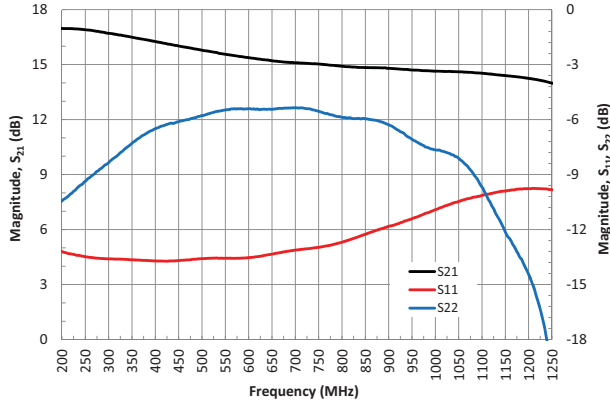

Gain versus Frequency, $P_{in} = 25dBm$
(CW, $V_D = 28V, I_{DQ} = 88mA$)

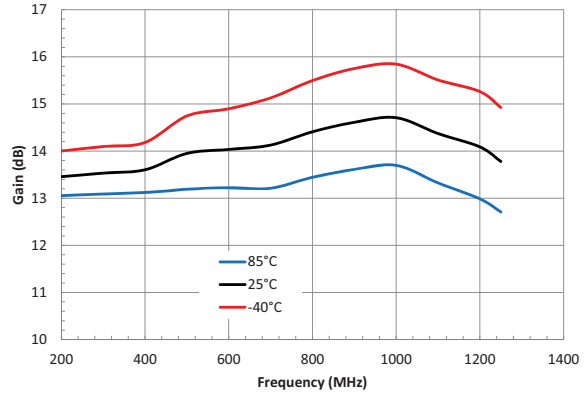

PAE versus Frequency, $P_{in} = 25dBm$
(CW, $V_D = 28V, I_{DQ} = 88mA$)

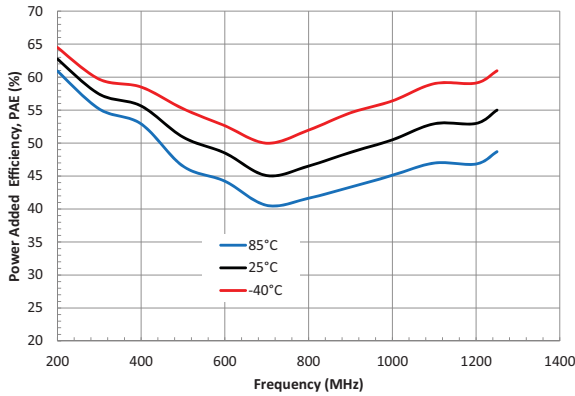

Input Return Loss versus Frequency, $P_{in} = 25dBm$
(CW, $V_D = 28V, I_{DQ} = 88mA$)

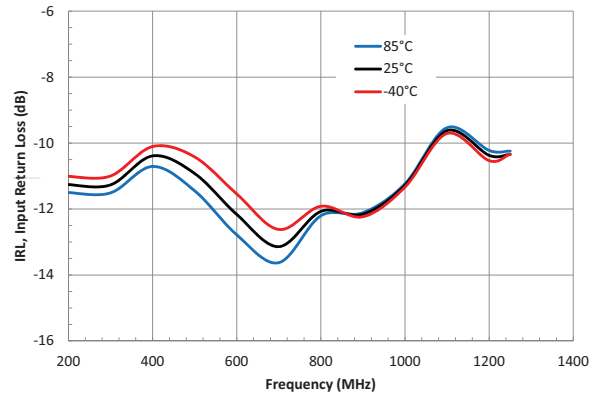

Gain/IRL versus Frequency, $P_{OUT} = 39.5dBm$
(CW, $V_D = 28V, I_{DQ} = 88mA$)

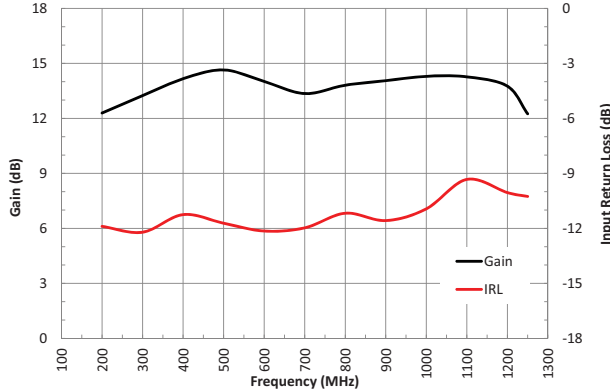

PAE versus Frequency, $P_{OUT} = 39.5dBm$
(CW, $V_D = 28V, I_{DQ} = 88mA$)



Typical Performance in Standard Fixed Tuned Test Fixture Matched for 225MHz to 1215MHz (T = 25 ° C, unless noted)

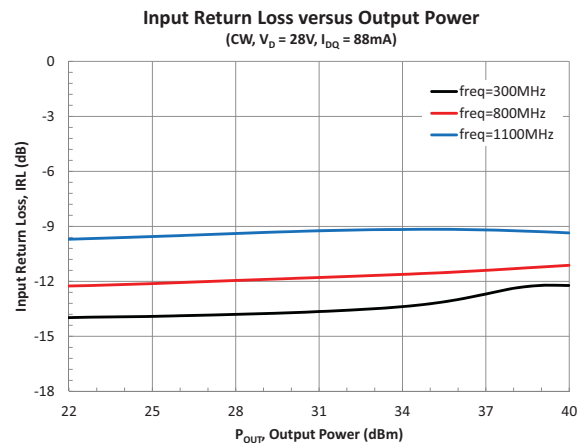
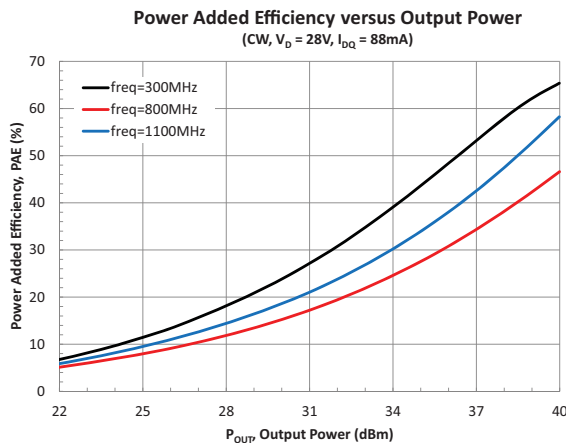
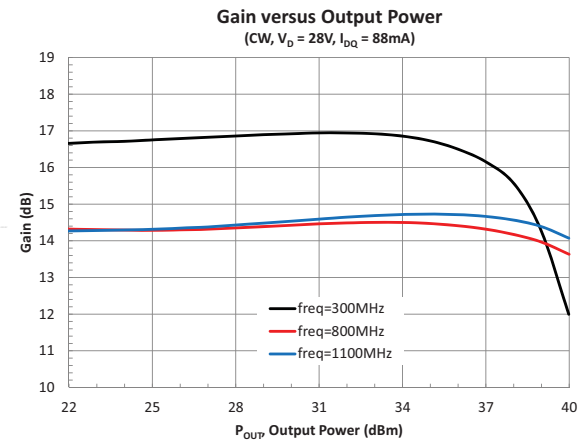
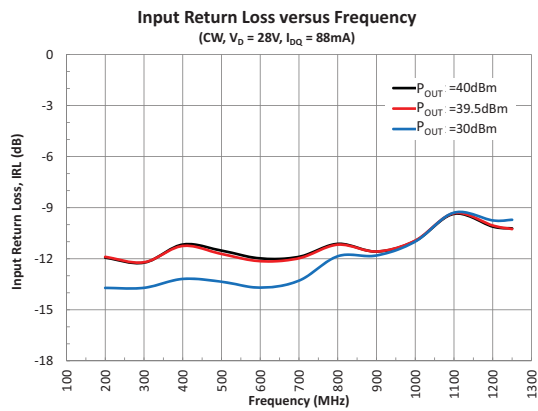
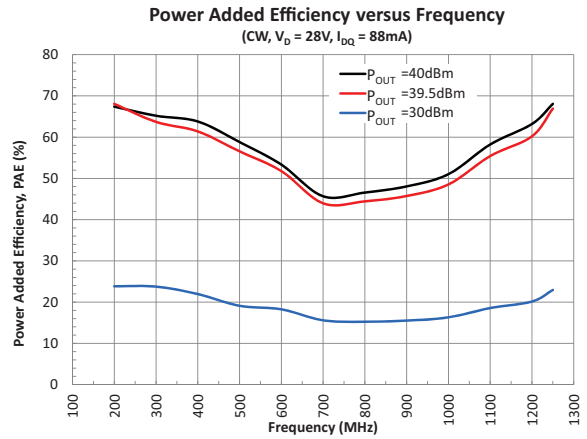
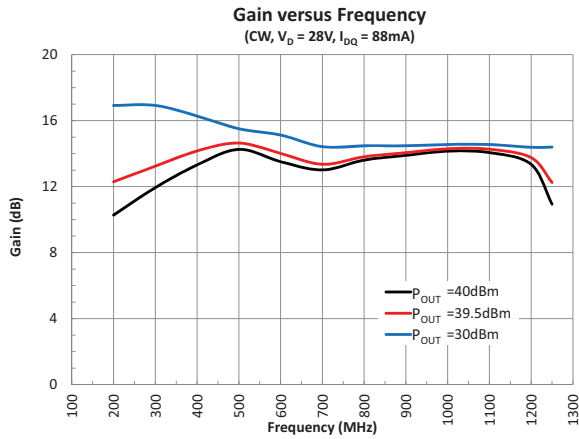

Typical Performance in Standard Fixed Tuned Test Fixture Matched for 225MHz to 1215MHz (T = 25 °C, unless noted)

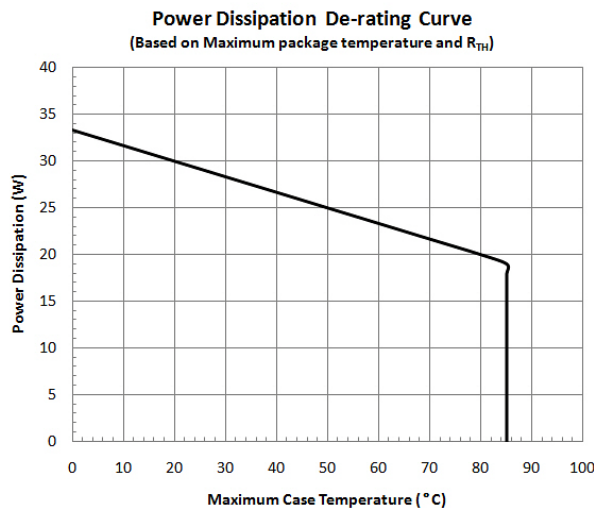
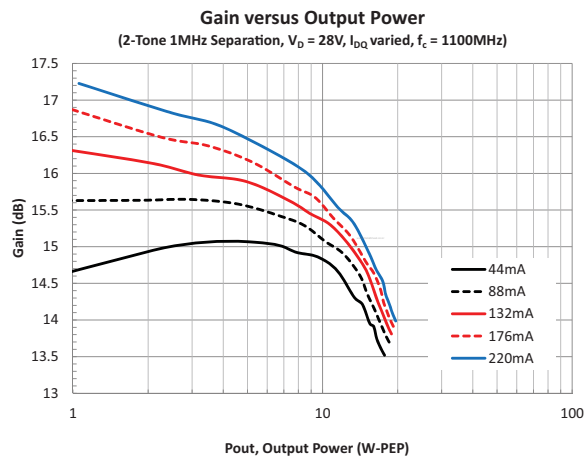
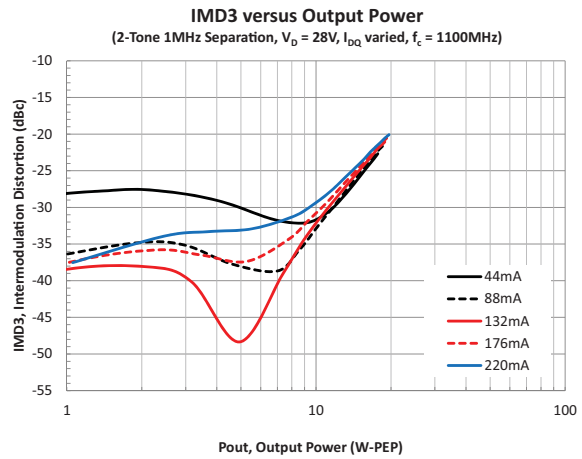
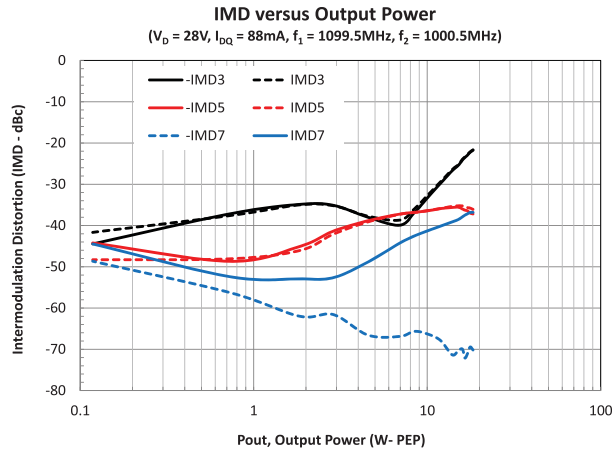

Package Drawing
(All dimensions in mm.)

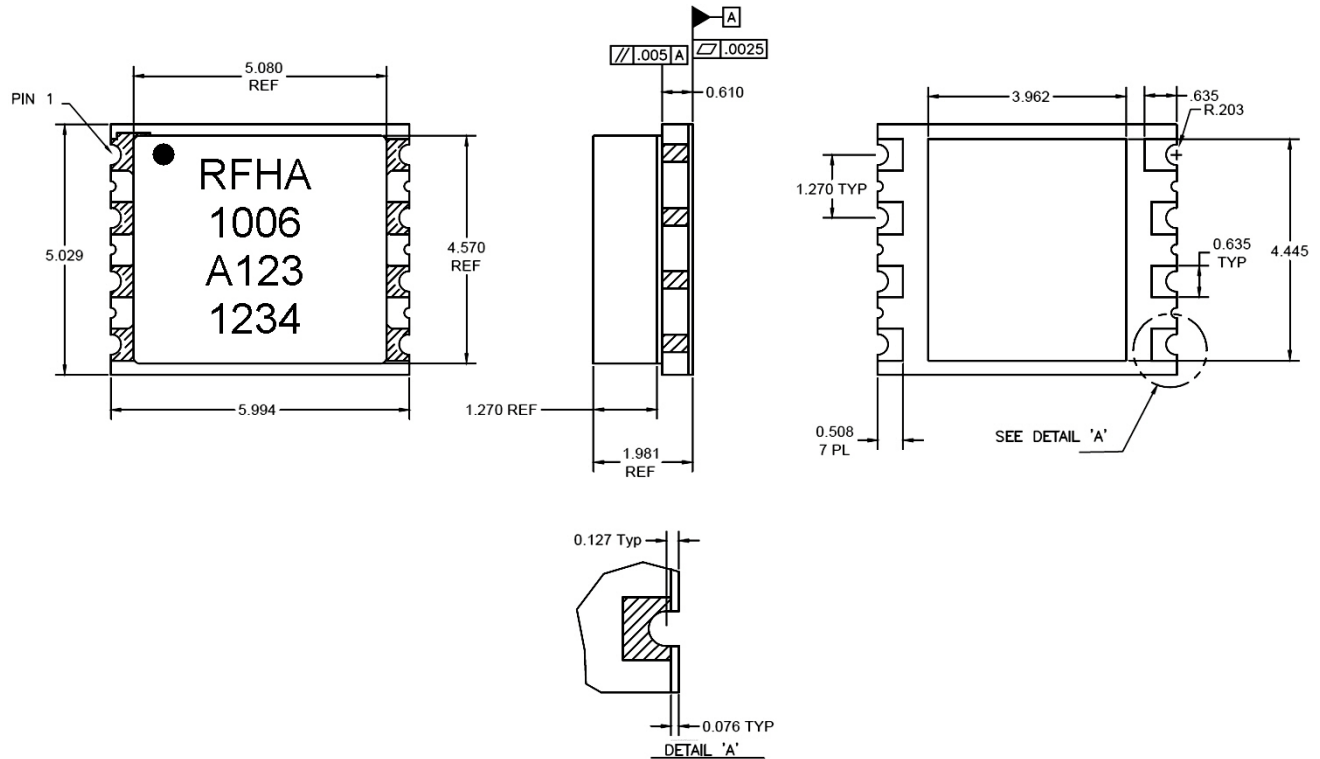

Pin Names and Descriptions

Pin	Name	Description
1	VGS	Gate DC Bias pin
2	RF IN	RF Input
3	RF IN	RF Input
4	N/C	No Connect
5	N/C	No Connect
6	RF OUT/VDS	RF Output/Drain DC Bias pin
7	RF OUT/VDS	RF Output/Drain DC Bias pin
8	N/C	No Connect
Backside	GND	Ground

Bias Instruction for RFHA1006 Evaluation Board

ESD Sensitive Material. Please use proper ESD precautions when handling devices of evaluation board. Evaluation board requires additional external fan cooling. Connect all supplies before powering evaluation board.

1. Connect RF cables at RFIN and RFOUT.
2. Connect ground to the ground supply terminal, and ensure that both the VG and VD grounds are also connected to this ground terminal.
3. Apply -5V to VG.
4. Apply 28V to VD.
5. Increase V_G until drain current reaches 88mA or desired bias point.
6. Turn on the RF input.

Typical test data provided is measured to SMA connector reference plane, and include evaluation board / broadband bias network mismatch and losses.

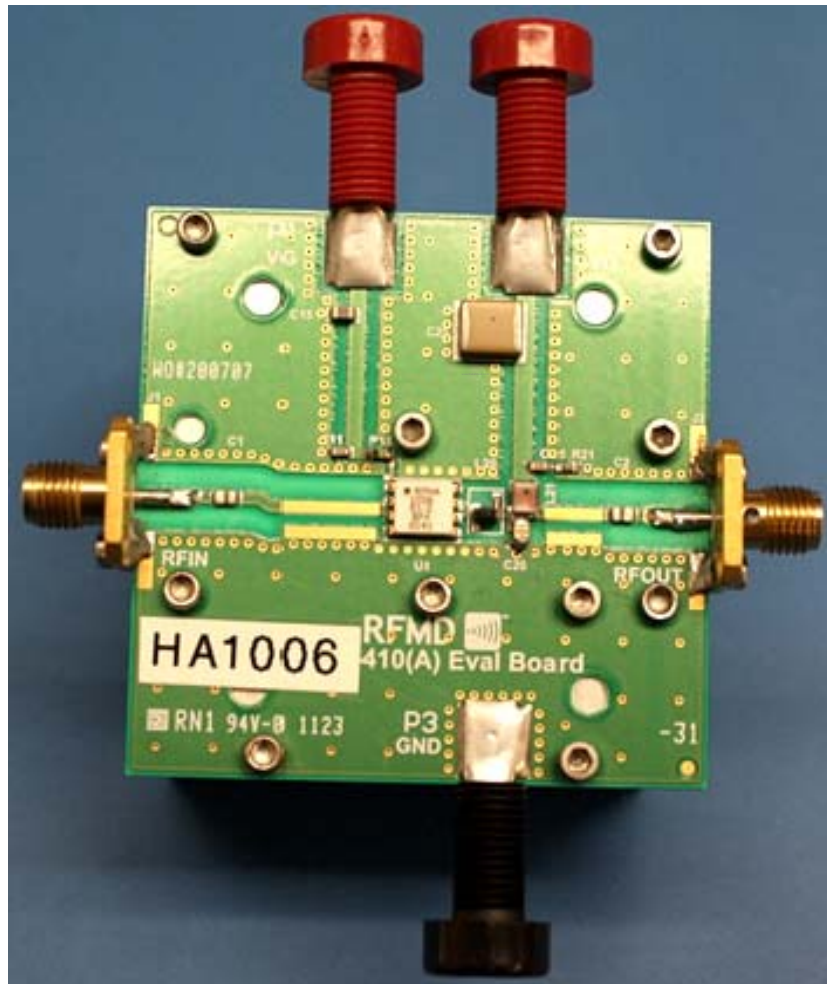

Evaluation Board Schematic

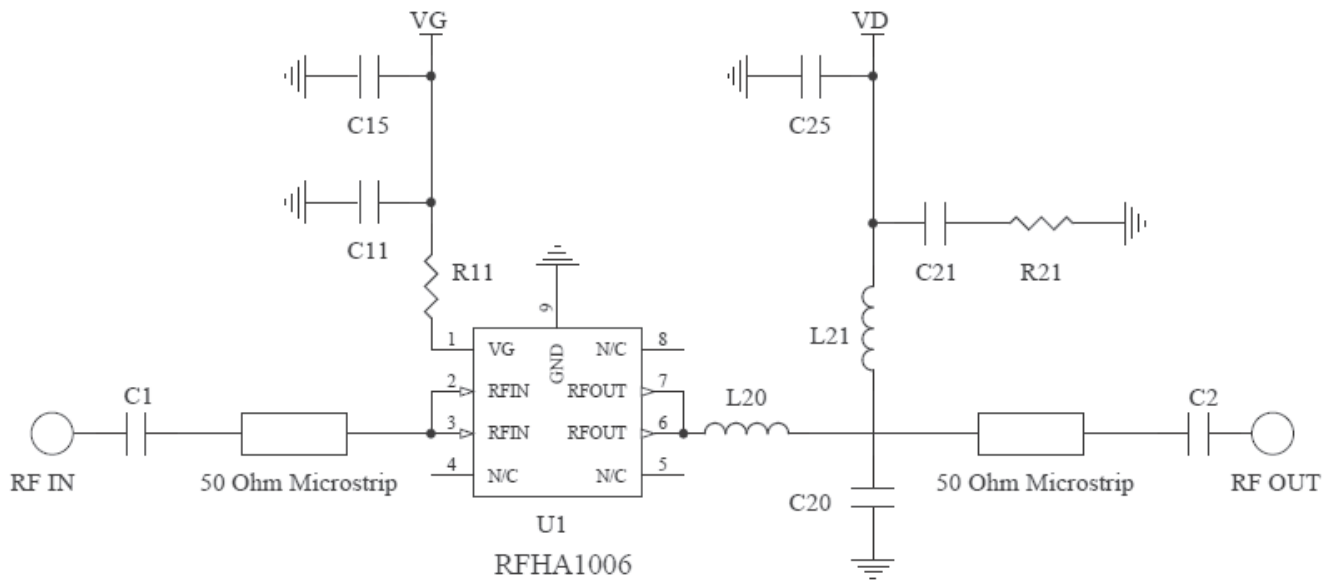

Evaluation Board Bill of Materials (BOM)

Component	Value	Manufacturer	Part Number
C1, C2	2400pF	Dielectric Labs Inc	C08BL242X-5UN-X0
C11	10000pF	Murata Electronics	GRM188R71H103KA01D
C15	10μF	Murata Electronics	GRM21BF51C106ZE15L
C20	3.3pF	ATC	100A3R3BW150XC
C25	4.7μF	Murata Electronics	GRM55ER72A475KA01L
R11	47nH	Murata Electronics	LQG11A47NJ00
L20	3.85nH	Coilcraft	0906-4KLB
L21	82nH	Coilcraft	1008HQ-82NXGLC
C21, R21	NOT USED	-	-

Evaluation Board Layout

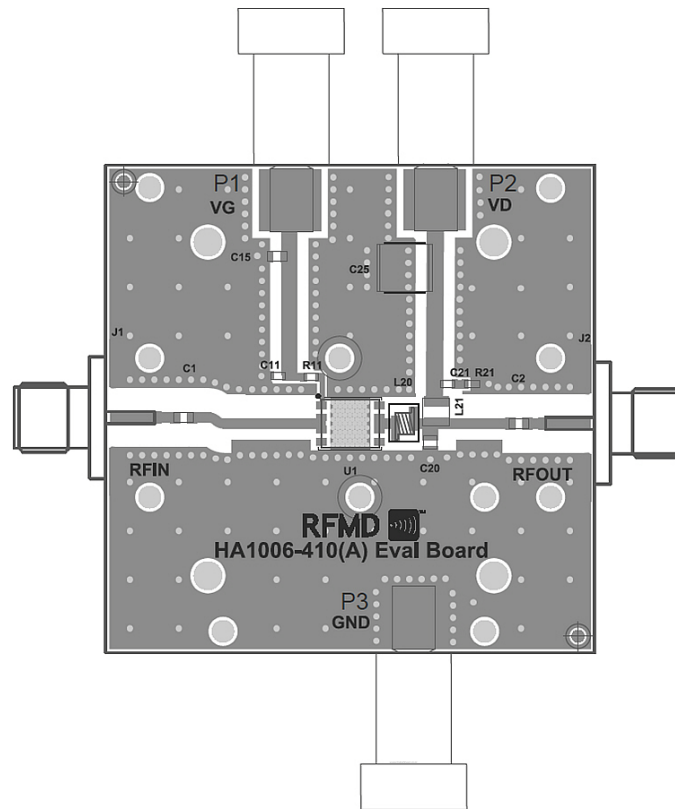

Device Impedances

Frequency (MHz)	RFHA1006PCBA-410 (225MHz to 1215MHz)	
	Z Source (Ω)	Z Load (Ω)
225MHz	40.4 + j3.4	40.6 + j14.1
300MHz	41.5 + j4.6	42.8 + j9.3
400MHz	42.8 + j5.5	42.7 + j5.8
950MHz	50.8 + j1.4	24.5 + j11.9
1100MHz	50.1 - j1.4	21.1 + j21.0
1215MHz	49 - j 2.8	19.8 + j27.6

Note: Device impedances reported are the measured evaluation board impedances chosen for a tradeoff of efficiency and peak power performance across the entire frequency bandwidth.

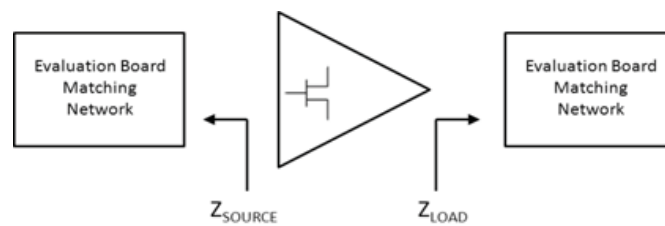

Device Handling/Environmental Conditions

RFMD does not recommend operating this device with typical drain voltage applied and the gate pinched off in a high humidity, high temperature environment.

GaN HEMT devices are ESD sensitive materials. Please use proper ESD precautions when handling devices or evaluation boards.

DC Bias

The GaN HEMT device is a depletion mode high electron mobility transistor (HEMT). At zero volts V_{GS} the drain of the device is saturated and uncontrolled drain current will destroy the transistor. The gate voltage must be taken to a potential lower than the source voltage to pinch off the device prior to applying the drain voltage, taking care not to exceed the gate voltage maximum limits. RFMD recommends applying $V_{GS} = -5V$ before applying any V_{DS} .

RF Power transistor performance capabilities are determined by the applied quiescent drain current. This drain current can be adjusted to trade off power, linearity, and efficiency characteristics of the device. The recommended quiescent drain current (I_{DQ}) shown in the RF typical performance table is chosen to best represent the operational characteristics for this device, considering manufacturing variations and expected performance. The user may choose alternate conditions for biasing this device based on performance tradeoffs.

Mounting and Thermal Considerations

The thermal resistance provided as R_{TH} (junction to case) represents only the packaged device thermal characteristics. This is measured using IR microscopy capturing the device under test temperature at the hottest spot of the die. At the same time, the package temperature is measured using a thermocouple touching the backside of the die embedded in the device heat sink but sized to prevent the measurement system from impacting the results. Knowing the dissipated power at the time of the measurement, the thermal resistance is calculated.

In order to achieve the advertised MTTF, proper heat removal must be considered to maintain the junction at or below the maximum of 200 °C. Proper thermal design includes consideration of ambient temperature and the thermal resistance from ambient to the back of the package including heat sinking systems and air flow mechanisms. Incorporating the dissipated DC power, it is possible to calculate the junction temperature of the device.