

# SKN 400



**Stud Diode**

## Rectifier Diode

### SKN 400

#### Features

- Reverse voltages up to 3000 V
- Hermetic metal case with ceramic insulator with extra long creepage distances
- Threaded stud ISO M24 x 1,5
- SKN: anode to stud

#### Typical Applications

- High voltage rectifier diode, especially for traction applications
- Cooling via heatsinks
- Non-controllable and half-controllable rectifiers
- Free-wheeling diodes
- Recommended snubber network:  
RC: 1  $\mu$ F, 20  $\Omega$  ( $P_R = 2$  W),  
 $R_p = 25$  k $\Omega$  ( $P_R = 20$  W)

| $V_{RSM}$<br>V | $V_{RRM}$<br>V | $I_{FRMS} = 700$ A (maximum value for continuous operation)<br>$I_{FAV} = 400$ A (sin. 180; $T_c = 100$ °C) |  |
|----------------|----------------|-------------------------------------------------------------------------------------------------------------|--|
| 1800           | 1800           | SKN 400/18                                                                                                  |  |
| 2400           | 2400           | SKN 400/24                                                                                                  |  |
| 2700           | 2700           | SKN 400/27                                                                                                  |  |
| 3000           | 3000           | SKN 400/30                                                                                                  |  |

| Symbol        | Conditions                                    | Values         | Units            |
|---------------|-----------------------------------------------|----------------|------------------|
| $I_{FAV}$     | sin. 180; $T_c = 85$ (100) °C                 | 445 (400)      | A                |
| $I_D$         | K 0,55; $T_a = 45$ °C; B2 / B6                | 310 / 450      | A                |
|               | K 0,55F; $T_a = 35$ °C; B2 / B6               | 700 / 1000     | A                |
| $I_{FSM}$     | $T_{vj} = 25$ °C; 10 ms                       | 9000           | A                |
|               | $T_{vj} = 160$ °C; 10 ms                      | 7500           | A                |
| $i^2t$        | $T_{vj} = 25$ °C; 8,3 ... 10 ms               | 400000         | A <sup>2</sup> s |
|               | $T_{vj} = 160$ °C; 8,3 ... 10 ms              | 280000         | A <sup>2</sup> s |
| $V_F$         | $T_{vj} = 25$ °C; $I_F = 1200$ A              | max. 1,45      | V                |
| $V_{(TO)}$    | $T_{vj} = 160$ °C                             | max. 0,9       | V                |
| $r_T$         | $T_{vj} = 160$ °C                             | max. 0,5       | m $\Omega$       |
| $I_{RD}$      | $T_{vj} = 160$ °C; $V_{RD} = V_{RRM}$         | max. 60        | mA               |
| $Q_{rr}$      | $T_{vj} = 160$ °C; $-di_F/dt = 10$ A/ $\mu$ s | 400            | $\mu$ C          |
| $R_{th(j-c)}$ |                                               | 0,11           | K/W              |
| $R_{th(c-s)}$ |                                               | 0,01           | K/W              |
| $T_{vj}$      |                                               | - 40 ... + 160 | °C               |
| $T_{stg}$     |                                               | - 55 ... + 160 | °C               |
| $V_{isol}$    |                                               | -              | V~               |
| $M_s$         | to heatsink                                   | 60             | Nm               |
| a             |                                               | 5 * 9,81       | m/s <sup>2</sup> |
| m             | approx.                                       | 500            | g                |
| Case          |                                               | E 17           |                  |



**SKN**

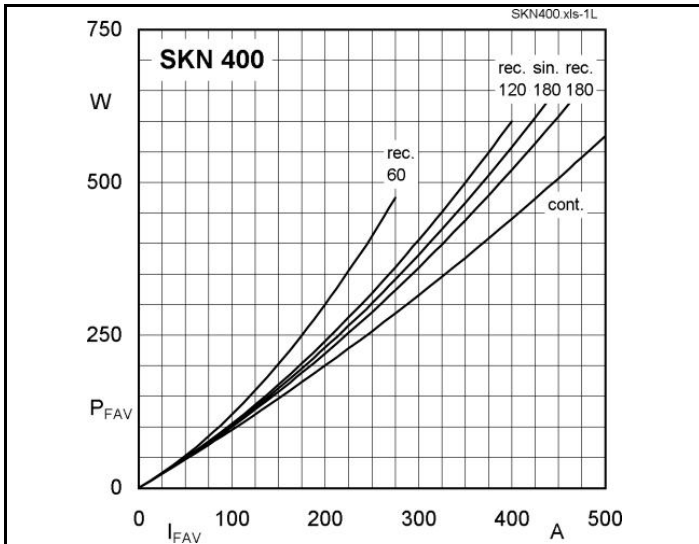

Fig. 1L Power dissipation vs. forward current

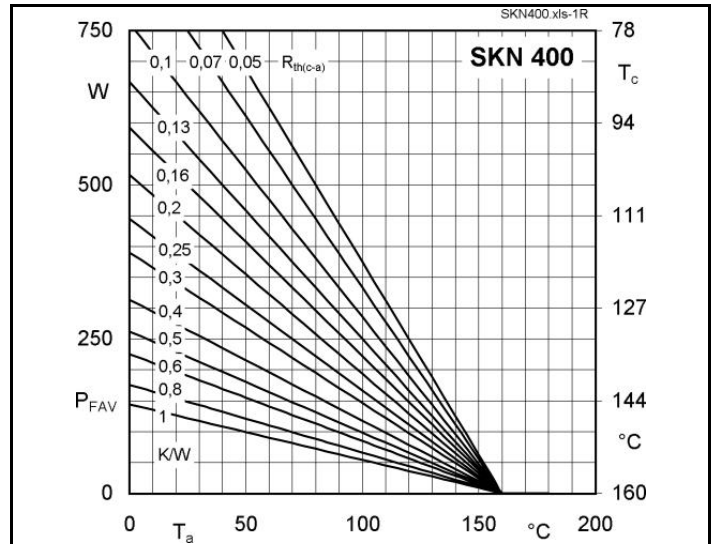

Fig. 1R Power dissipation vs. ambient temperature

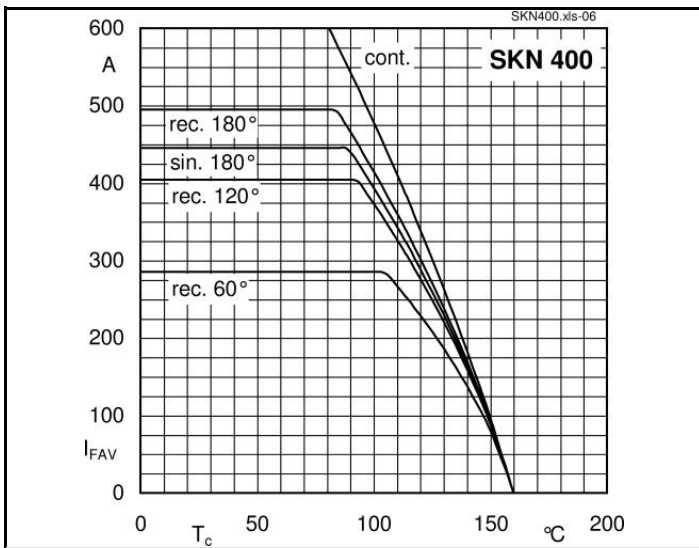

Fig. 2 Forward current vs. case temperature

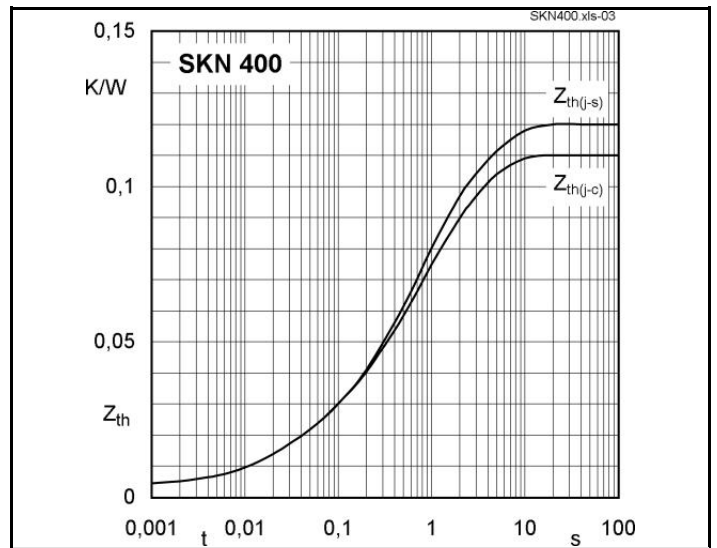

Fig. 4 Transient thermal impedance vs. time

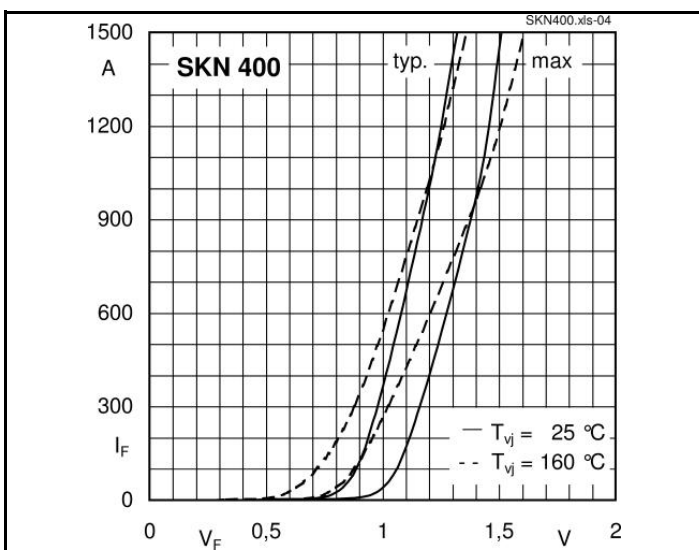

Fig. 5 Forward characteristics

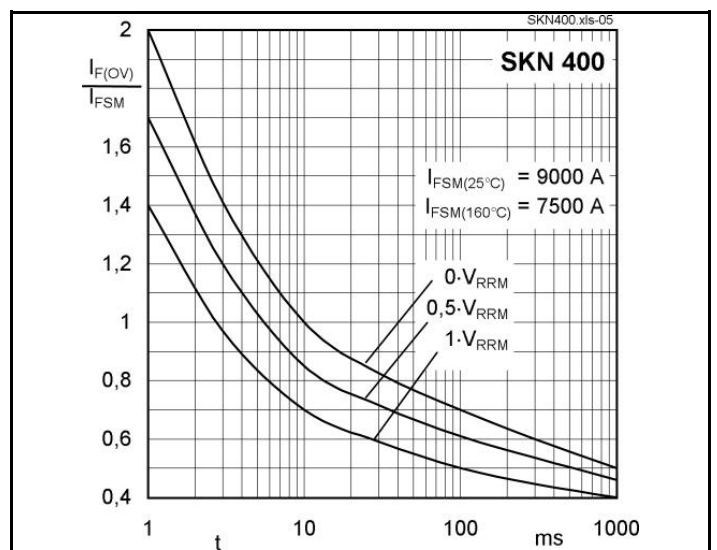
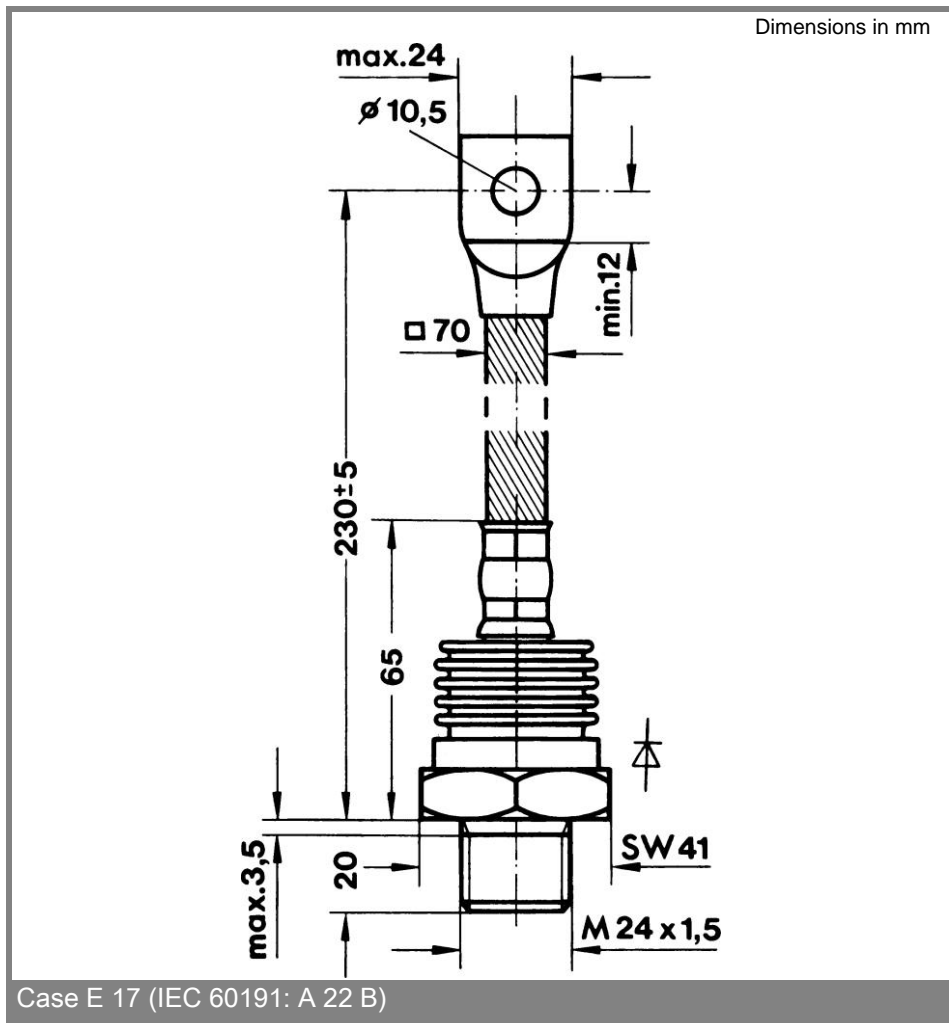

Fig. 6 Surge overload current vs. time



This technical information specifies semiconductor devices but promises no characteristics. No warranty or guarantee expressed or implied is made regarding delivery, performance or suitability.