

# PQ05RF1 Series

1A Output Low Power-Loss Voltage Regulators

## Features

- Compact resin full-mold package
- Low power-loss (Dropout voltage: MAX.0.5V)
- Built-in ON/OFF control terminal (PQ05RF1/PQ05RF11 series)
- Built-in output voltage minute adjustment terminal (Critical rate of ripple rejection is improved.) (PQ05RF1V series)
- Lead forming type (PQ05RF1A/1B series) is also available.

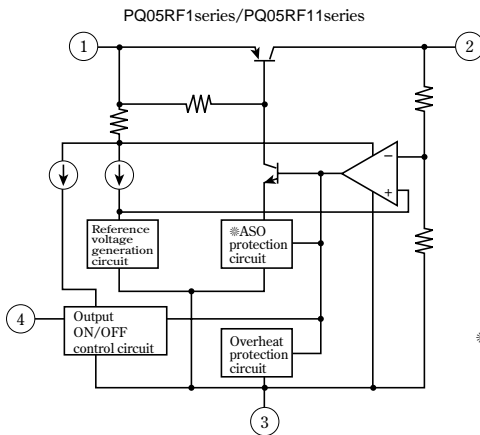
## Model Line-ups

Output voltage	5Voutput	9Voutput	12Voutput
Output voltage precision:±5%	PQ05RF1	PQ09RF1	PQ12RF1
Output voltage precision:±2.5%	PQ05RF11	PQ09RF11	PQ12RF11
Minute adjustment (Output voltage adjustment range:±10%)	PQ05RF1V	PQ09RF1V	PQ12RF1V

## Applications

- Seris power supply for various electronic equipment such as VCRs and musical instruments

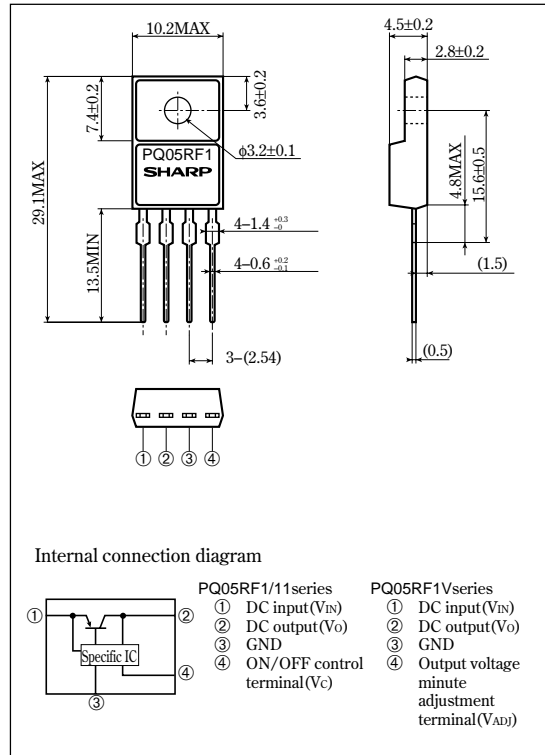
## Equivalent Circuit Diagram



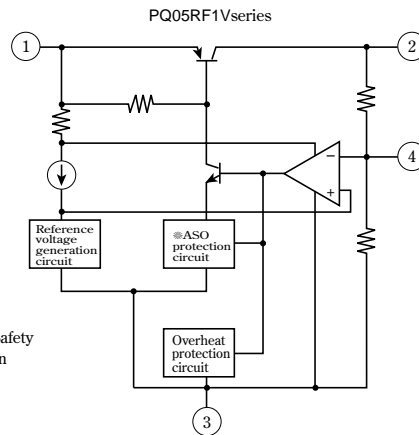
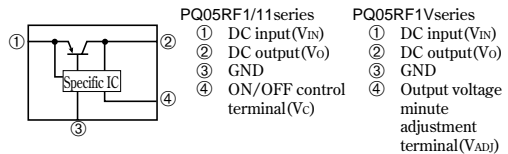
※ASO : Area of Safety Operation

## Outline Dimensions

(Unit : mm)



### Internal connection diagram



•Please refer to the chapter " Handling Precautions ".

**Absolute Maximum Ratings**

(T<sub>a</sub>=25°C)

Parameter		Symbol	Rating	Unit
*1	Input voltage	V <sub>IN</sub>	35	V
*1	ON/OFF control terminal voltage	PQ05RF1 series	35	V
		PQ05RF11 series		
	Output current	I <sub>O</sub>	1	A
	Power dissipation(No heat sink)	P <sub>D1</sub>	1.5	W
	Power dissipation(With infinite heat sink)	P <sub>D2</sub>	15	W
*2	Junction temperature	T <sub>j</sub>	150	°C
	Operating temperature	T <sub>opr</sub>	-20 to +80	°C
	Storage temperature	T <sub>stg</sub>	-40 to +150	°C
	Soldering temperature	T <sub>sol</sub>	260 (For 10s)	°C

\*1 All are open except GND and applicable terminals.

\*2 Overheat protection may operate at 125<=T<sub>j</sub><=150°C

**Electrical Characteristics**

(Unless otherwise specified, condition shall be I<sub>O</sub>=0.5A, T<sub>a</sub>=25°C, \*3)

Parameter		Symbol	Conditions	MIN.	TYP.	MAX.	Unit
Output voltage	PQ05RF1/PQ05RF1V	V <sub>O</sub>	-	4.75	5.0	5.25	V
	PQ09RF1/PQ09RF1V			8.55	9.0	9.45	
	PQ12RF1/PQ12RF1V			11.4	12.0	12.6	
	PQ05RF11			4.88	5.0	5.12	
	PQ09RF11			8.78	9.0	9.22	
	PQ12RF11			11.7	12.0	12.3	
Load regulation		R <sub>egL</sub>	I <sub>O</sub> =5mA to 1A	-	0.1	2.0	%
Line regulation		R <sub>egI</sub>	*4, I <sub>O</sub> =5mA	-	0.5	2.5	%
Temperature coefficient of output voltage		T <sub>cV<sub>O</sub></sub>	T <sub>j</sub> =0 to 125°C, I <sub>O</sub> =5mA	-	±0.02	-	%/°C
Ripple rejection	PQ05RF1/PQ05RF11 series	RR	Refer to Fig. 2.	45	55	-	dB
	PQ05RF1V series			55	-	-	
Dropout voltage		V <sub>FO</sub>	*5	-	-	0.5	V
ON-state voltage for control	PQ05RF1/PQ05RF11 series	V <sub>C(ON)</sub>	-	2.0 *6	-	-	V
ON-state current for control	PQ05RF1/PQ05RF11 series	I <sub>C(ON)</sub>	V <sub>C</sub> =2.7V	-	-	20	μA
OFF-state voltage for control	PQ05RF1/PQ05RF11 series	V <sub>C(OFF)</sub>	-	-	-	0.8	V
OFF-state current for control	PQ05RF1/PQ05RF11 series	I <sub>C(OFF)</sub>	V <sub>C</sub> =0.4V	-	-	-0.4	mA
Quiescent current		I <sub>q</sub>	I <sub>O</sub> =0	-	-	10	mA
Output voltage minute adjustment characteristics	PQ05RF1V	V <sub>O(ADJ)</sub>	-	4.5	5.0	5.5	V
	PQ09RF1V			8.1	9.0	9.9	
	PQ12RF1V			10.8	12.0	13.2	

\*3 PQ05RF1 series:V<sub>IN</sub>=7V, PQ09RF1 series:V<sub>IN</sub>=15V, PQ12RF1 series:V<sub>IN</sub>=18V

\*4 PQ05RF1/PQ05RF11/PQ05RF1V:V<sub>IN</sub>=6 to 12V

PQ09RF1/PQ09RF11/PQ09RF1V:V<sub>IN</sub>=10 to 25V

PQ12RF1/PQ12RF11/PQ12RF1V:V<sub>IN</sub>=13 to 29V

\*5 Input voltage shall be the value when output voltage is 95% in comparison with the initial value.

\*6 In case of opening control terminal ④, output voltage turns on. (PQ05RF1/PQ05RF11 series)

Fig.1 Test Circuit

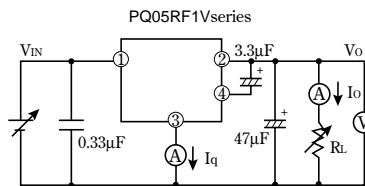
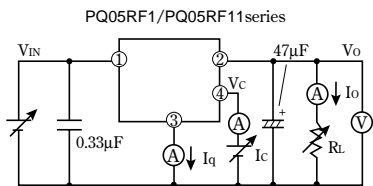


Fig.2 Test Circuit of Ripple Rejection

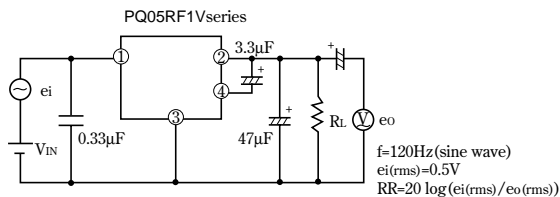
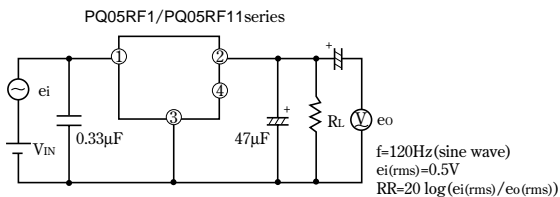
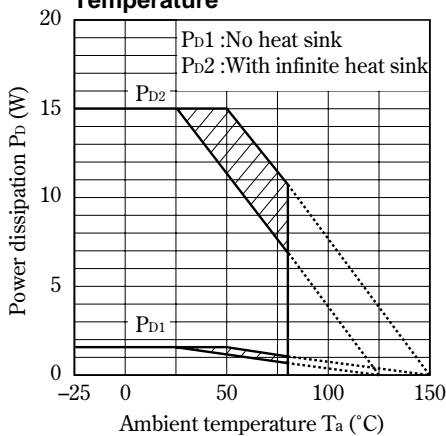


Fig.3 Power Dissipation vs. Ambient Temperature



Note) Oblique line portion : Overheat protection may operate in this area.

Fig.4 Overcurrent Protection Characteristics (Typical Value)

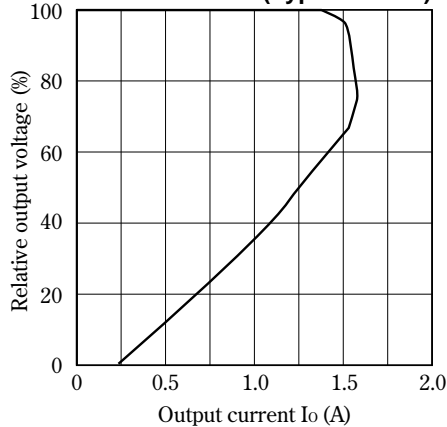


Fig.5 Output Voltage Minute Adjustment Characteristics (PQ05RF1V)

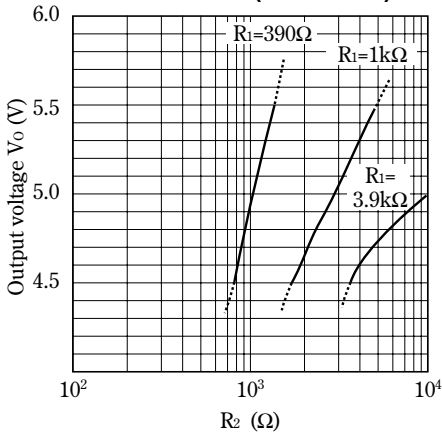
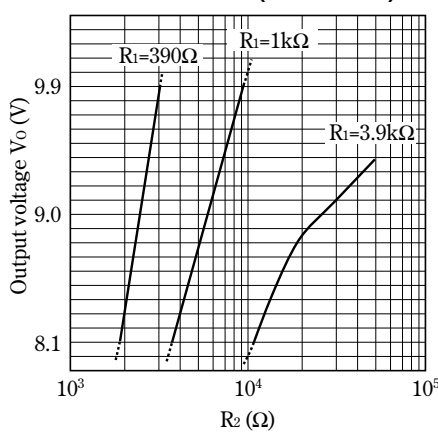
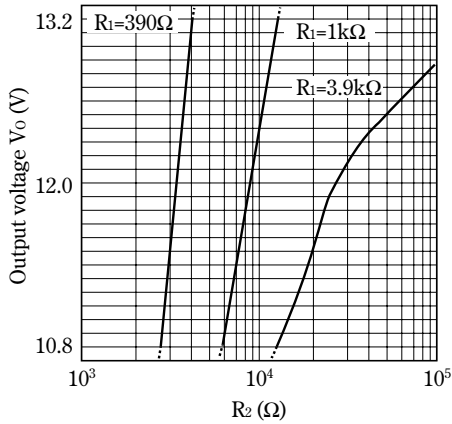


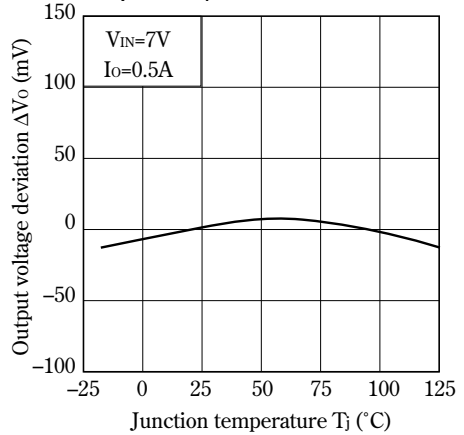
Fig.6 Output Voltage Minute Adjustment Characteristics (PQ09RF1V)



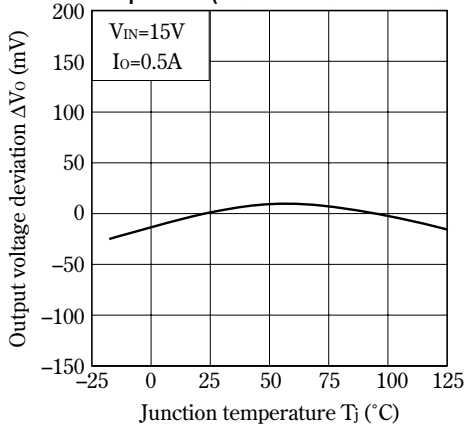
**Fig.7 Output Voltage Minute Adjustment Characteristics (PQ12RF1V)**



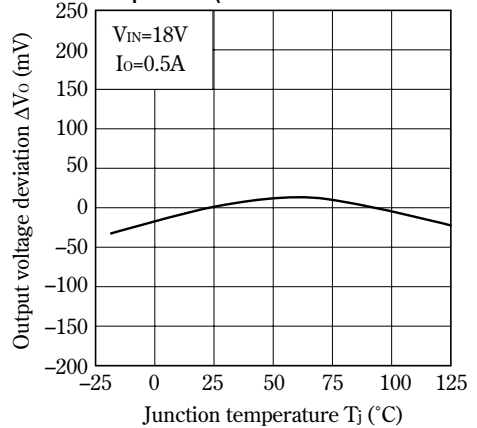
**Fig.8 Output Voltage Deviation vs. Junction Temperature (PQ05RF1/PQ05RF11/PQ05RF1V)**



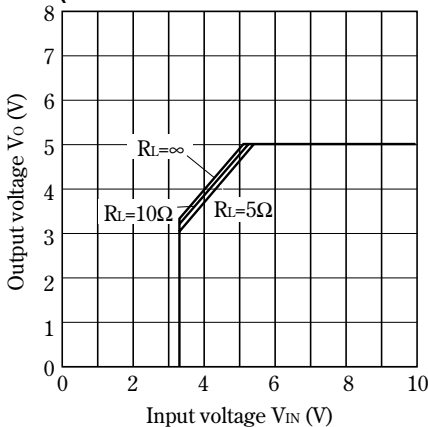
**Fig.9 Output Voltage Deviation vs. Junction Temperature (PQ09RF1/PQ09RF11/PQ09RF1V)**



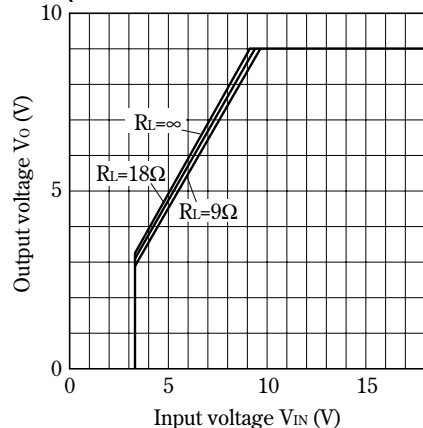
**Fig.10 Output Voltage Deviation vs. Junction Temperature (PQ12RF1/PQ12RF11/PQ12RF1V)**



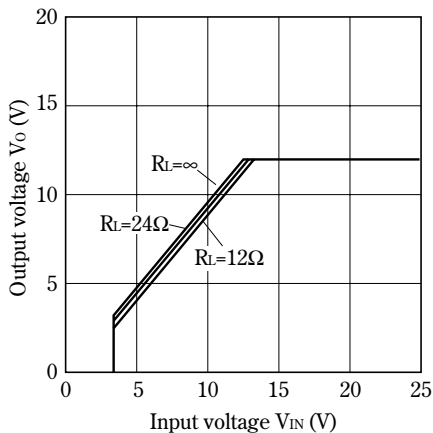
**Fig.11 Output Voltage vs. Input Voltage (PQ05RF1/PQ05RF11/PQ05RF1V)**



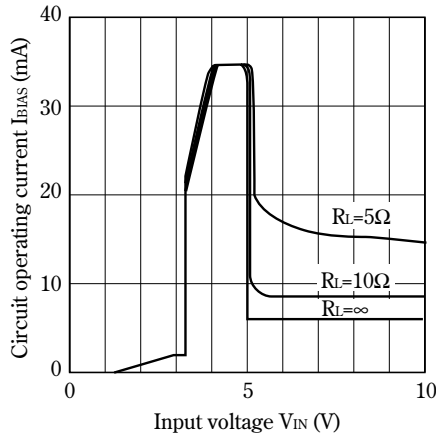
**Fig.12 Output Voltage vs. Input Voltage (PQ09RF1/PQ09RF11/PQ09RF1V)**



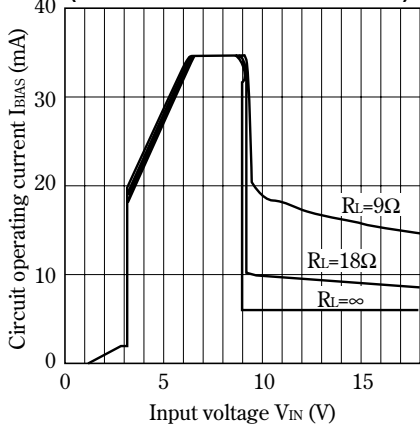
**Fig.13 Output Voltage vs. Input Voltage (PQ12RF1/PQ12RF11/PQ12RF1V)**



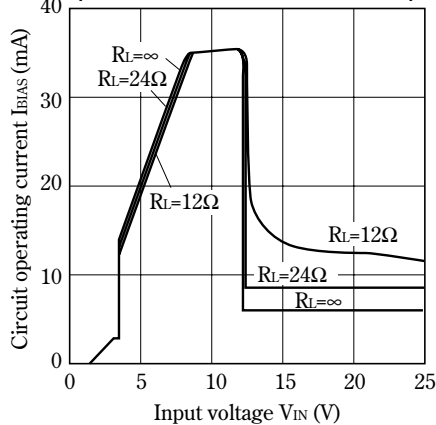
**Fig.14 Circuit Operating Current vs. Input Voltage (PQ05RF1/PQ05RF11/PQ05RF1V)**



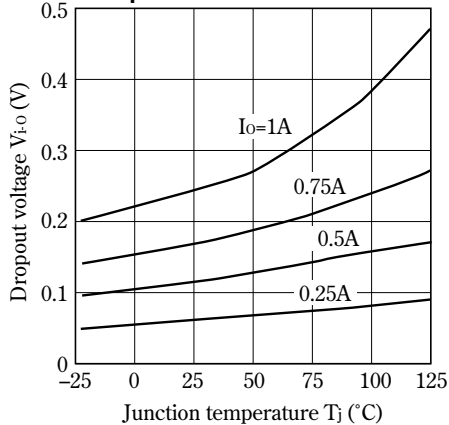
**Fig.15 Circuit Operating Current vs. Input Voltage (PQ09RF1/PQ09RF11/PQ09RF1V)**



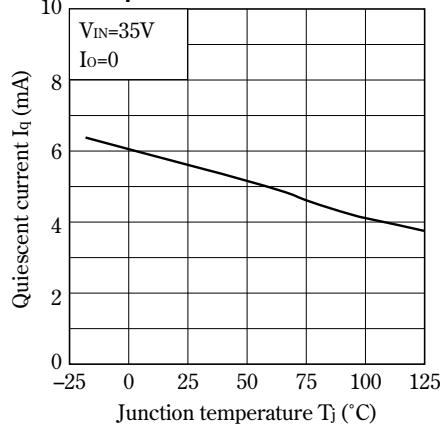
**Fig.16 Circuit Operating Current vs. Input Voltage (PQ12RF1/PQ12RF11/PQ12RF1V)**



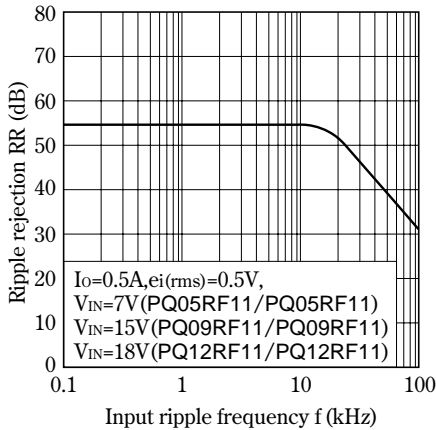
**Fig.17 Dropout Voltage vs. Junction Temperature**



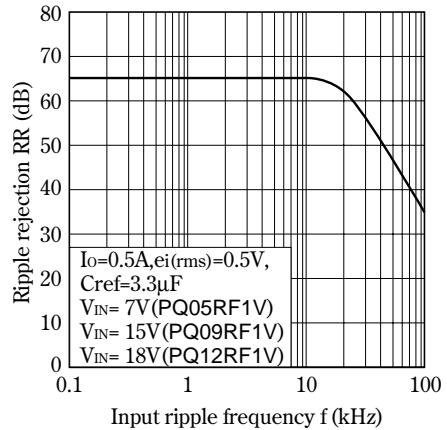
**Fig.18 Quiescent Current vs. Junction Temperature**



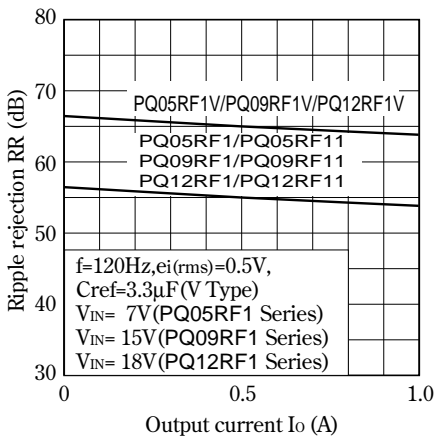
**Fig.19 Ripple Rejection vs. Input Ripple Frequency**  
(PQ05RF1/PQ05RF11/PQ09RF1/PQ09RF11/PQ12RF1/PQ12RF11)



**Fig.20 Ripple Rejection vs. Input Ripple Frequency**  
(PQ05RF1V/PQ09RF1V/PQ12RF1V)

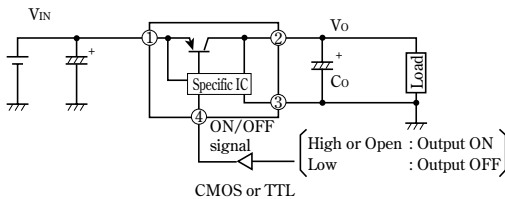


**Fig.21 Ripple Rejection vs. Output Current**

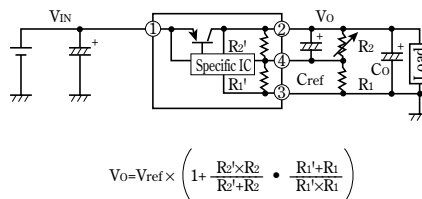


■ Typical Application

PQ05RF1/PQ05RF11 Series



PQ05RF1V Series



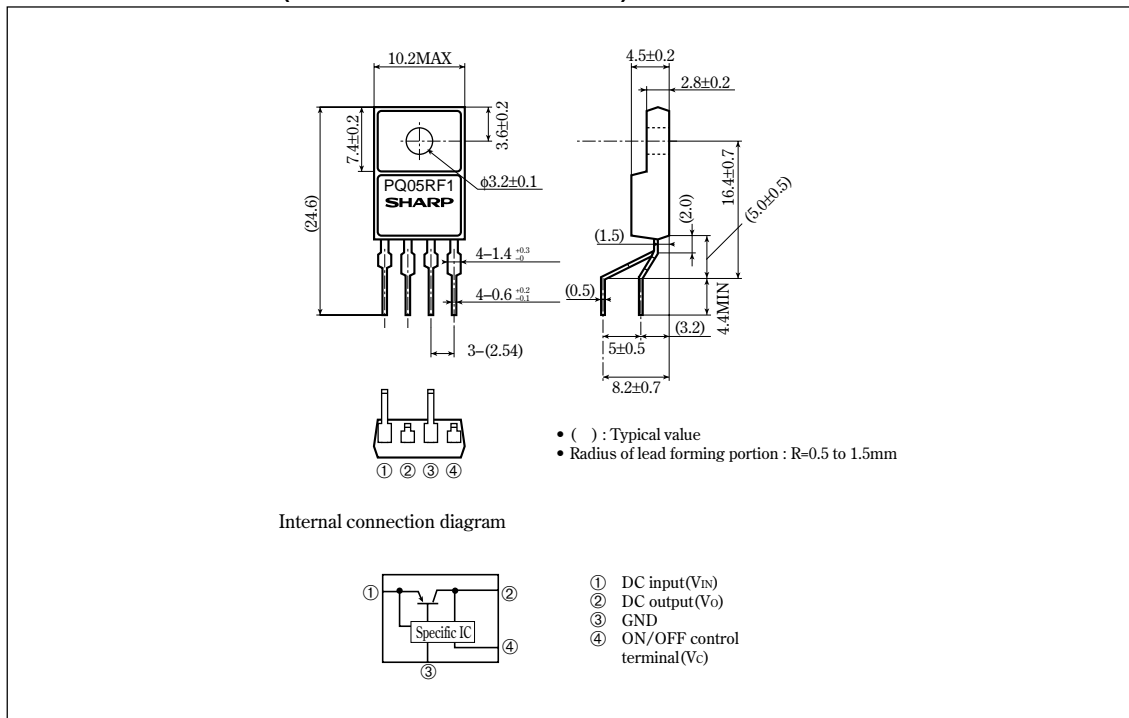
$V_{ref}$  Nearly=1.26V,  $R_1'$  Nearly=390Ω  
 PQ05RF1V :  $R_2'$  Nearly=1.16kΩ  
 PQ09RF1V :  $R_2'$  Nearly=2.40kΩ  
 PQ12RF1V :  $R_2'$  Nearly=3.32kΩ  
 (Note)  $R_1'$  and  $R_2'$  are built in a specific IC.

Model Line-ups for Lead Forming Type

Output voltage	5V output	9V output	12V output
Output voltage precision:±5%	PQ05RF1A	PQ09RF1A	PQ12RF1A
Output voltage precision:±2.5%	PQ05RF1B	PQ09RF1B	PQ12RF1B

Outline Dimensions (PQ05RF1A/PQ05RF1B series)

(Unit : mm)



Note) The value absolute maximum ratings and electrical characteristics is same as ones of PQ05RF1/11 series.

Precautions for Use

(1) Minute adjustment of output voltage (PQ05RF1V series)

If the external resistor is attached to the terminals ②, ③ and ④, minute adjustment of output voltage is possible. (Refer to the example of basic circuit (PQ05RF1V series) and Fig.5 to 7.)