

### Technical Data

### S6700 / S5700 Series

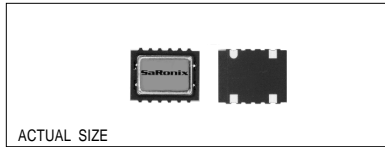
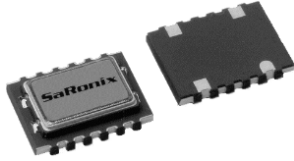

#### Description

A surface mountable, digitally temperature compensated crystal oscillator for both 3 and 5Volt operations. The very small size, extremely low profile and low power consumption of this TCXO/TCVCXO makes it ideally suited for portable, wireless applications such as cellular and cordless telephones. The hermetically sealed ceramic package is fully compatible with standard surface mounting processes.

#### Applications & Features

- Cellular Telephones (GSM, PDC, TDMA, CDMA)
- GPS Devices
- Mobile and Portable Radio/Telephone
- Communications Transceivers
- Cordless Telephones
- 3 and 5Volt operations
- Very low profile, 2mm max height, rugged, package
- Hermetically sealed packages are compatible with standard board washing techniques
- Available on tape & reel; 18mm tape, 500pcs per reel

<b>Frequencies:</b>	12.60, 12.80, 12.96, 13.00, 14.30, 14.40, 16.80, 19.20, 19.68 MHz
<b>Frequency Stability:</b>	vs. temperature: $\pm 2.5$ or $\pm 5.0$ ppm max vs. supply voltage: $\pm 0.3$ ppm (5% change) vs. aging: $\pm 1$ ppm (1 Year @ +40°C) vs. load: $\pm 0.3$ ppm (CL: 10 pF $\pm 10\%$ ) vs. hysteresis: $\pm 0.2$ ppm (temp change 1°C per minute) vs. perturbations: 0.5 ppm peak-to-peak max vs. temp cycle: $\pm 0.1$ ppm (10 cycles, min to max storage temp)
<b>Temperature Range:</b>	Operating: -30 to +80°C or -20 to +75°C Storage: -40 to +85°C
<b>Supply Voltage:</b>	3V $\pm 5\%$ or 5V $\pm 10\%$
<b>Supply Current:</b>	2.0mA max
<b>Output Level:</b>	1.0V peak-to-peak min, Clipped Sinewave
<b>Output Load:</b>	10K $\Omega$ // 10pF
<b>Frequency Adjustment:</b>	Frequency Control Range: $\pm 5$ ppm min to $\pm 12$ ppm max, 0.5 to 2.5V Control V Input Impedance: 1M $\Omega$ min, 2M $\Omega$ typ Modulation Bandwidth: 1 kHz min Transfer Function: Frequency Increases when Control Voltage Increases
<b>Phase Noise:</b>	-70 dBc/Hz max @ 10Hz -100 dBc/Hz max @ 100Hz -118 dBc/Hz max @ 1kHz -125 dBc/Hz max @ 10kHz -130 dBc/Hz max @ 100kHz
<b>Mechanical:</b>	Shock: MIL-STD-883, Method 2002, Condition B Solderability: MIL-STD-883, Method 2003 Vibration: MIL-STD-883, Method 2007, Condition A Solvent Resistance: MIL-STD-202, Method 215 Resistance to Soldering Heat: MIL-STD-202, Method 210, Condition I or J
<b>Environmental:</b>	Gross Leak Test: MIL-STD-883, Method 1014, Condition C Fine Leak Test: MIL-STD-883, Method 1014, Condition A2 Thermal Shock: MIL-STD-883, Method 1011, Condition A Moisture Resistance: MIL-STD-883, Method 1004

#### Part Numbering Guide

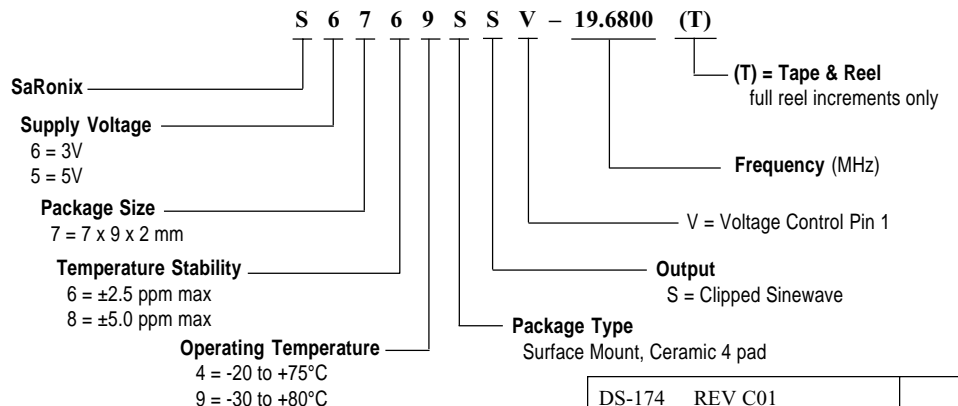

DS-174 REV C01

### Technical Data

S6700 / S5700 Series

#### Package Details

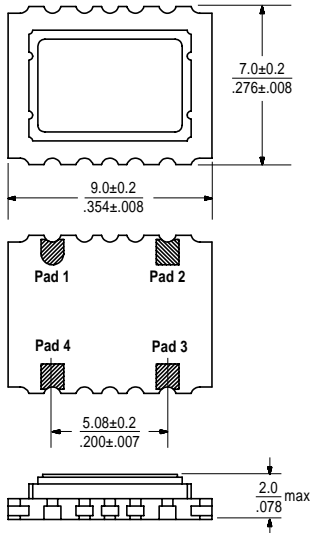

#### Pad Functions:

Pad 1: Control Voltage (NC on TCXO) Pad 3: Output  
 Pad 2: GND Pad 4: VCC

#### Marking Format \*

Voltage, Frequency Stab. and Temp. Range

1 = 3V, 2.5ppm, $\pm 5$ to 12ppm FC, -30 to +80°C
2 = 3V, 2.5ppm, $\pm 5$ to 12ppm FC, -20 to +75°C
3 = 3V, 5.0ppm, $\pm 5$ to 12ppm FC, -30 to +80°C
4 = 3V, 5.0ppm, $\pm 5$ to 12ppm FC, -20 to +75°C
5 = 5V, 2.5ppm, $\pm 5$ to 12ppm FC, -30 to +80°C
6 = 5V, 2.5ppm, $\pm 5$ to 12ppm FC, -20 to +75°C
7 = 5V, 5.0ppm, $\pm 5$ to 12ppm FC, -30 to +80°C
8 = 5V, 5.0ppm, $\pm 5$ to 12ppm FC, -20 to +75°C

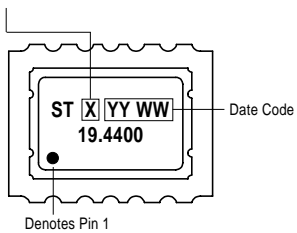

\* Exact location of items may vary

#### Recommended Land Pattern

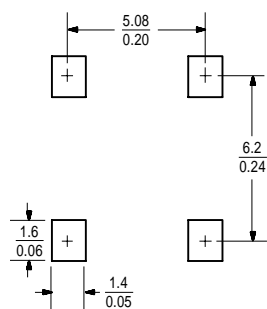

Scale: None (Dimensions in  $\frac{\text{mm}}{\text{inches}}$ )

#### Typical Frequency vs. Temperature Characteristics

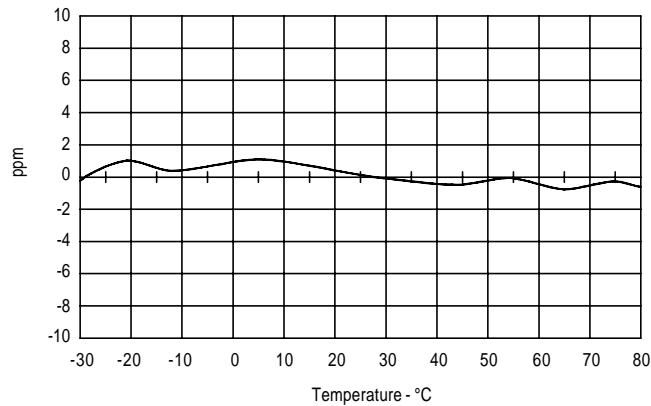

#### Solder Reflow Guide

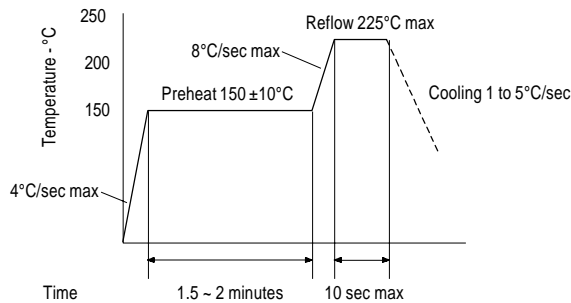

#### Test Circuit

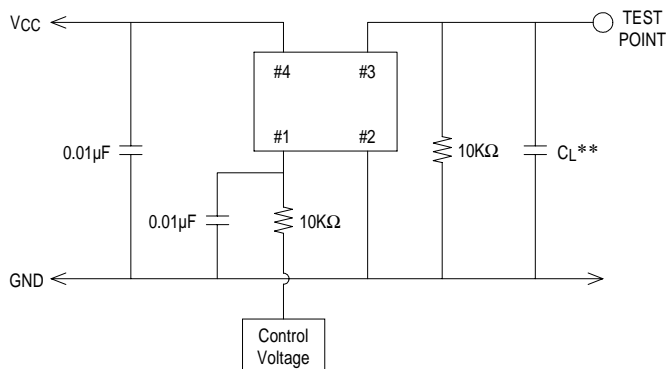

\*\* $C_L$  = 10pF (Including probe and jig capacitance)

All specifications are subject to change without notice.

DS-174 REV C01