



OP-06

HIGH-GAIN INSTRUMENTATION OPERATIONAL AMPLIFIER

Precision Monolithics Inc.

FEATURES

- Very High Voltage Gain 1,000V/mV Min
- Low Offset Voltage and Offset Current
- Low Drift vs. Temperature (TCV_{OS}) 0.8μV/°C Max
- Low Input Voltage and Current Noise
- Low Offset Voltage Drift with Time
- High Common-Mode Rejection 120dB Typ
- High Power Supply Rejection 2μV/V Max
- Wide Supply Range ±3.0V to ±22V
- MIL-STD-883 Processing Available
- Slew Rate to 100V/μs
- Available in Die Form

ORDERING INFORMATION †

T _A = 25°C V _{OS} MAX (mV)	PACKAGE		OPERATING TEMPERATURE RANGE
	TO-99 8-PIN	CERDIP 8-PIN	
0.2	OP06AJ*	—	MIL
0.5	OP06FJ	—	COM
0.5	OP06BJ	—	MIL
1.3	OP06GJ	OP06GZ	COM

* For devices processed in total compliance to MIL-STD-883, add /883 after part number. Consult factory for 883 data sheet.

† Burn-in is available on commercial and industrial temperature range parts in cerdip, plastic dip, and TO-can packages. For ordering information, see 1990/91 Data Book, Section 2.

GENERAL DESCRIPTION

The OP-06 monolithic instrumentation operational amplifier is designed for accurate high-gain amplification of low level signals. High common-mode rejection reduces signal degradation when large common-mode voltages are present.

Superior DC input characteristics include very low offset voltage and current, extremely high open-loop gain, low 1/f and wideband noise, and low "popcorn" noise. Low offset voltage drift is improved by a nulling technique that optimizes TCV_{OS} performance when V_{OS} is nulled to zero. Very high common-mode and power supply rejection enable accurate performance in noisy environments.

Flexible external compensation provides wide-bandwidth and high slew rate operation in high closed-loop gain applications. Excellent long-term stability, and compatibility with MIL-STD-883 processing, make the OP-06 an excellent choice for high-reliability applications. For example, process control and aerospace applications; including strain gauge and thermocouple amplifiers, low-noise audio amplifiers, and instrumentation amplifiers. The OP-06 is a direct replacement for all 725 types providing superior DC and noise performance plus the unique feature of **complete input differential voltage and output short-circuit protection**.

PIN CONNECTIONS

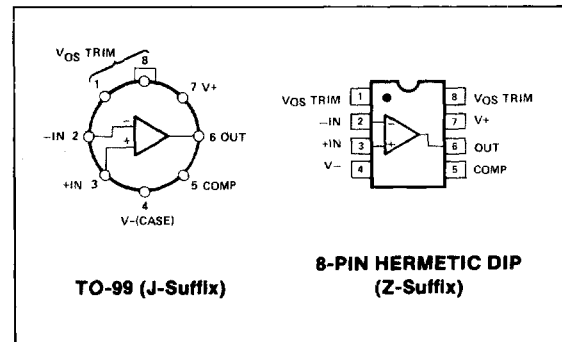

SIMPLIFIED SCHEMATIC

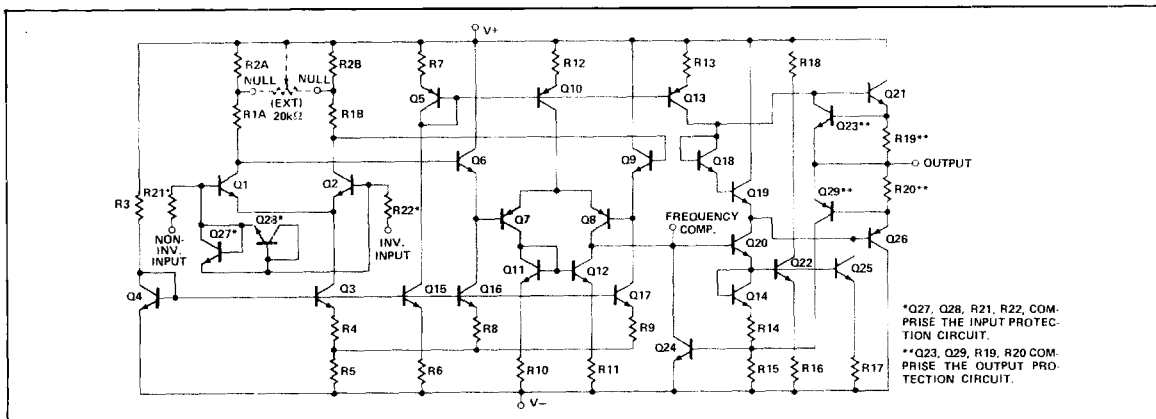

**ABSOLUTE MAXIMUM RATINGS (Note 3)**

Supply Voltage	±22V
Differential Input Voltage	±30V
Input Voltage (Note 1)	±22V
Output Short-Circuit Duration	Indefinite
Storage Temperature Range	-65°C to +150°C
Operating Temperature Range	
OP-06A, OP-06B	-55°C to +125°C
OP-06F, OP-06G	0°C to +70°C
Lead Temperature Range (Soldering, 60 sec)	+300°C
Junction Temperature	-65°C to +150°C

PACKAGE TYPE	θ_{JA} (NOTE 2)	θ_{JC}	UNITS
TO-99 (J)	150	18	°C/W
8-Pin Hermetic DIP (Z)	148	16	°C/W

NOTES:

- For supply voltages less than ±22V, the absolute maximum input voltage is equal to the supply voltage.
- θ_{JA} is specified for worst case mounting conditions, i.e., θ_{JA} is specified for device in socket for TO and CerDIP packages.
- Absolute ratings apply to both DICE and packaged parts, unless otherwise noted.

ELECTRICAL CHARACTERISTICS at $V_S = \pm 15V$, $T_A = 25^\circ C$, unless otherwise noted.

PARAMETER	SYMBOL	CONDITIONS	OP-06A			OP-06B/F			OP-06G			UNITS
			MIN	TYP	MAX	MIN	TYP	MAX	MIN	TYP	MAX	
Input Offset Voltage	V_{OS}	$R_S \leq 20k\Omega$ (Note 2)	—	0.06	0.2	—	0.2	0.5	—	0.4	1.3	mV
Input Offset Current	I_{OS}		—	0.3	2.0	—	0.75	5.0	—	2	13	nA
Input Bias Current	I_B		—	30	70	—	30	80	—	40	110	nA
Input Noise Voltage Density	e_n	$f_O = 10\text{Hz}$ (Note 1)	—	9.0	15.0	—	9.0	15.0	—	9.0	15.0	$nV/\sqrt{\text{Hz}}$
		$f_O = 100\text{Hz}$ (Note 1)	—	8.0	9.0	—	8.0	9.0	—	8.0	9.0	
		$f_O = 1000\text{Hz}$ (Note 1)	—	7.0	7.5	—	7.0	7.5	—	7.0	7.5	
Input Noise Current Density	i_n	$f_O = 10\text{Hz}$ (Note 1)	—	0.5	1.2	—	0.5	1.2	—	0.6	1.4	$pA/\sqrt{\text{Hz}}$
		$f_O = 100\text{Hz}$ (Note 1)	—	0.25	0.6	—	0.25	0.6	—	0.3	0.7	
		$f_O = 1000\text{Hz}$ (Note 1)	—	0.15	0.25	—	0.15	0.25	—	0.2	0.3	
Input Resistance	R_{IN}	(Note 3)	0.8	1.8	—	0.7	1.8	—	0.5	1.5	—	M Ω
Large-Signal Voltage Gain	A_{VO}	$R_L \geq 2k\Omega$, $V_O = \pm 10V$	1,000	3,000	—	1,000	3,000	—	500	3,000	—	V/mV
Output Voltage Swing	V_O	$R_L \geq 10k\Omega$	±12.5	±13.0	—	±12.5	±13.0	—	±12.0	±13.0	—	V
		$R_L \geq 2k\Omega$	±12.0	±12.8	—	±12.0	±12.8	—	±11.5	±12.8	—	
		$R_L \geq 1k\Omega$	±11.0	±12.5	—	±11.0	±12.5	—	—	±12.0	—	
Input Voltage Range	IVR		±13.5	±14.0	—	±13.5	±14.0	—	±13.5	±14.0	—	V
Common-Mode Rejection Ratio	CMRR	$V_{CM} = \pm 13.5V$, $R_S \leq 20k\Omega$	114	120	—	114	120	—	110	115	—	dB
Power Supply Rejection Ratio	PSRR	$V_S = \pm 3V$ to $\pm 18V$, $R_S \leq 20k\Omega$	—	0.5	2.0	—	1.0	5.0	—	2.0	10	$\mu V/V$
Power Consumption	P_d		—	90	120	—	90	120	—	110	150	mW
Large-Signal Voltage Gain	A_{VO}	$R_L \geq 500\Omega$, (Note 3) $V_O = \pm 0.5V$, $V_S = \pm 3V$	100	600	—	100	800	—	60	600	—	V/mV
Power Consumption	P_d	$V_S = \pm 3V$	—	4	6	—	4	6	—	4	8	mW

NOTES:

- Sample tested.
- Thermoelectric voltages generated by dissimilar metals at the contacts to the input terminals can degrade drift performance. Both sides of the contacts should be kept at approximately the same temperature. All temperature gradients should be minimized.
- Guaranteed by design.

**ELECTRICAL CHARACTERISTICS** at $V_S = \pm 15V$, $-55^\circ C \leq T_A \leq +125^\circ C$, unless otherwise noted.

PARAMETER	SYMBOL	CONDITIONS	OP-06A			OP-06B			UNITS
			MIN	TYP	MAX	MIN	TYP	MAX	
Input Offset Voltage (Without external trim)	V_{OS}	$R_S \leq 20k\Omega$ (Note 2)	—	0.08	0.28	—	0.3	0.7	mV
Average Input Offset Voltage Drift (Without external trim)	TCV_{OS}	$R_S = 50\Omega$ (Notes 1, 2)	—	0.3	0.8	—	0.7	2.0	$\mu V/^\circ C$
Average Input Offset Voltage Drift (With external trim)	TCV_{OSn}	$R_S = 50\Omega$ (Notes 2, 3) $R_P = 20k\Omega$	—	0.2	0.6	—	0.28	1.0	$\mu V/^\circ C$
Input Offset Current	I_{OS}	T_A MAX T_A MIN	—	0.25 0.8	1.0 4.0	—	0.6 2.0	4.0 18.0	nA
Average Input Offset Current Drift	TCI_{OS}	(Note 1)	—	3	20	—	8	90	$pA/^\circ C$
Input Bias Current	I_B	T_A MAX T_A MIN	—	22 40	60 120	—	25 45	70 180	nA
Common-Mode Rejection Ratio	CMRR	$V_{CM} = \pm 13.5V$ $R_S \leq 20k\Omega$	109	112	—	109	112	—	dB
Power Supply Rejection Ratio	PSRR	$V_S = \pm 3V$ to $\pm 18V$ $R_S \leq 20k\Omega$	—	1	5	—	2	8	$\mu V/V$
Large-Signal Voltage Gain	A_{VO}	$V_O = \pm 10V$; $R_L \geq 2k\Omega$ T_A MAX T_A MIN	1,000 700	3,500 2,000	—	1,000 700	3,500 1,800	—	V/mV
Output Voltage Swing	V_O	$R_L \geq 2k\Omega$	± 12.0	± 12.6	—	± 12.0	± 12.6	—	V

ELECTRICAL CHARACTERISTICS at $V_S = \pm 15V$, $0^\circ C \leq T_A \leq 70^\circ C$, unless otherwise noted.

PARAMETER	SYMBOL	CONDITIONS	OP-06F			OP-06G			UNITS
			MIN	TYP	MAX	MIN	TYP	MAX	
Input Offset Voltage (Without external trim)	V_{OS}	$R_S \leq 20k\Omega$ (Note 2)	—	0.25	0.6	—	0.5	1.6	mV
Average Input Offset Voltage Drift (Without external trim)	TCV_{OS}	$R_S = 50\Omega$ (Notes 1, 2)	—	0.7	2.0	—	1.4	4.5	$\mu V/^\circ C$
Average Input Offset Voltage Drift (With external trim)	TCV_{OSn}	$R_S = 50\Omega$ (Notes 2, 3) $R_P = 20k\Omega$	—	0.28	1.0	—	0.5	1.5	$\mu V/^\circ C$
Input Offset Current	I_{OS}	T_A MAX T_A MIN	—	0.65 2.0	5.0 18.0	—	2.0 3.0	15 25	nA
Average Input Offset Current Drift	TCI_{OS}	(Note 1)	—	8	90	—	14	150	$pA/^\circ C$
Input Bias Current	I_B	T_A MAX T_A MIN	—	30 45	80 180	—	35 45	110 180	nA
Common-Mode Rejection Ratio	CMRR	$V_{CM} = \pm 13.5V$ $R_S \leq 20k\Omega$	109	112	—	95	110	—	dB
Power Supply Rejection Ratio	PSRR	$V_S = \pm 3V$ to $\pm 18V$ $R_S \leq 20k\Omega$	—	1.5	7.0	—	3.0	15	$\mu V/V$
Large-Signal Voltage Gain	A_{VC}	$V_O = \pm 10V$; $R_L \geq 2k\Omega$ T_A MAX T_A MIN	1,000 800	3,500 1,800	—	400 300	3,200 1,700	—	V/mV
Output Voltage Swing	V_O	$R_L \geq 2k\Omega$	± 12.0	± 12.6	—	± 11.0	± 12.6	—	V

NOTES:

- Sample tested.
- Thermoelectric voltages generated by dissimilar metals at the contacts to the input terminals can degrade drift performance. Both sides of the

- contacts should be kept at approximately the same temperature. All temperature gradients should be minimized.
- Guaranteed by input bias current.

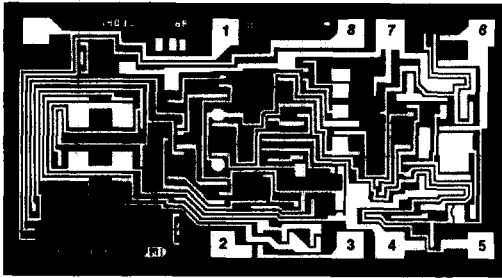
DICE CHARACTERISTICS

1. NULL
2. INVERTING INPUT
3. NONINVERTING INPUT
4. V-
5. COMPENSATION
6. OUTPUT
7. V+
8. NULL

DIE SIZE 0.095 × 0.051 inch, 4845 sq. mils
(2.41 × 1.30 mm, 3.13 sq. mm)

For additional DICE ordering information,
refer to 1990/91 Data Book, Section 2.

WAFER TEST LIMITS at $V_S = \pm 15V$, $T_A = 25^\circ C$ for OP-06N, OP-06G and OP-06GR devices; $T_A = 125^\circ C$ for OP-06NT and OP-06GT devices, unless otherwise noted. (Note 2)

PARAMETER	SYMBOL	CONDITIONS	OP-06NT LIMIT	OP-06N LIMIT	OP-06GT LIMIT	OP-06G LIMIT	OP-06GR LIMIT	UNITS
Input Offset Voltage	V_{OS}	$R_S \leq 20k\Omega$	0.3	0.2	0.7	0.5	1.3	mV MAX
Input Offset Current	I_{OS}		1	2	4	5	13	nA MAX
Input Bias Current	I_B		60	70	70	80	110	nA MAX
Input Resistance Differential Mode	R_{IN}	(Note 1)	—	0.8	—	0.7	0.5	MΩ MIN
Input Voltage Range	IVR		±13.0	±13.5	±13.0	±13.5	±13.5	V MIN
Common-Mode Rejection Ratio	CMRR	$V_{CM} = \pm 13.5$ $R_S \leq 20k\Omega$	108	114	108	114	110	dB MIN
Power Supply Rejection Ratio	PSRR	$V_S = \pm 3V$ to $\pm 18V$ $R_S \leq 20k\Omega$	6	2	8	5	10	μV/V MAX
Output Voltage Swing	V_O	$R_L \geq 10k\Omega$	—	±12.5	—	±12.5	±12.0	V MIN
		$R_L \geq 2k\Omega$	±12.0	±12.0	±12.0	±12.0	±11.5	
		$R_L \geq 1k\Omega$	—	±11.0	—	±11.0	—	
Large-Signal Voltage Gain	A_{VO}	$R_L \geq 2k\Omega$ $V_O = \pm 10V$	1000	1000	800	1000	500	V/mV MIN
Differential Input Voltage			±30	±30	±30	±30	±30	V MAX
Power Consumption ($V_{OUT} = 0V$)	P_d		—	120	—	120	150	mW MAX

NOTE:

Electrical tests are performed at wafer probe to the limits shown. Due to variations in assembly methods and normal yield loss, yield after packaging is not guaranteed for standard product dice. Consult factory to negotiate specifications based on dice lot qualification through sample lot assembly and testing.

TYPICAL ELECTRICAL CHARACTERISTICS at $V_S = \pm 15V$, $T_A = +25^\circ C$, unless otherwise noted.

PARAMETER	SYMBOL	CONDITIONS	OP-06NT TYPICAL	OP-06N TYPICAL	OP-06GT TYPICAL	OP-06G TYPICAL	OP-06GR TYPICAL	UNITS
Average Input Offset Voltage Drift	TCV_{OS}	$R_S \leq 50\Omega$	0.3	0.3	0.7	0.7	1.4	μV/°C
Nullled Input Offset Voltage Drift	TCV_{OSn}	$R_S \leq 50k\Omega$ $R_P = 20k\Omega$	0.2	0.2	0.28	0.28	0.5	μV/°C
Average Input Offset Current Drift	TCI_{OS}		3	3	8	8	14	pA/°C

NOTES:

1. Guaranteed by input bias current.
2. For +25°C specifications of OP-06NT and OP-06GT, see OP-06N and OP-06G respectively.

TYPICAL PERFORMANCE CHARACTERISTICS

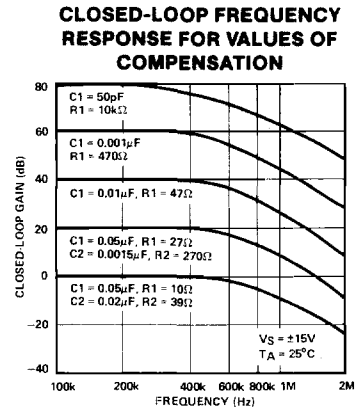
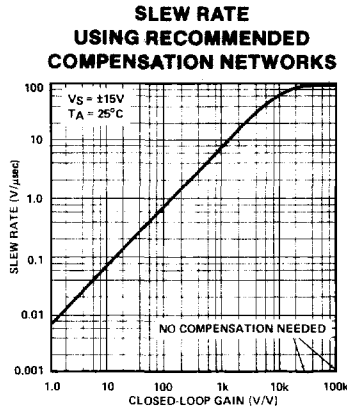
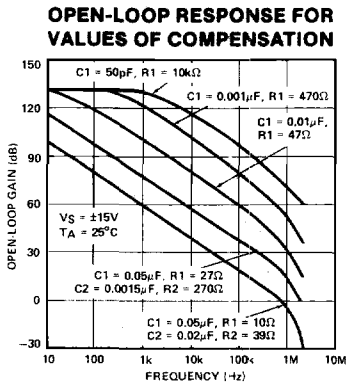

FREQUENCY COMPENSATION

COMPENSATION VALUES

A_{vcl}	R_1 (Ω)	C_1 (μF)	R_2 (Ω)	C_2 (μF)
10000	10k	50pF	—	—
1000	470	0.001	—	—
100	47	0.01	—	—
10	27	0.05	270	0.0015
1	10	0.05	39	0.02

COMPENSATION CIRCUIT (J or Z PACKAGE)

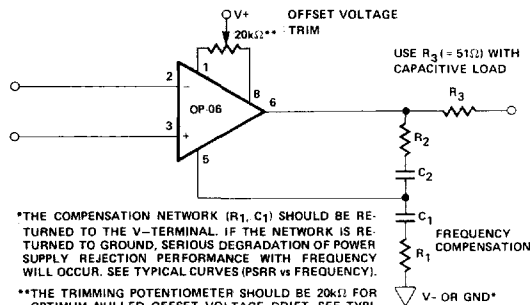

TYPICAL PERFORMANCE CHARACTERISTICS

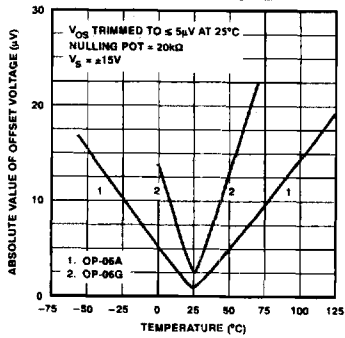
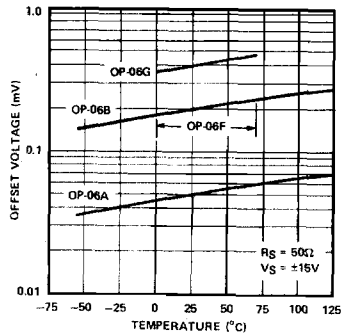
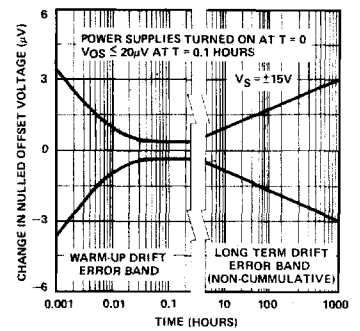
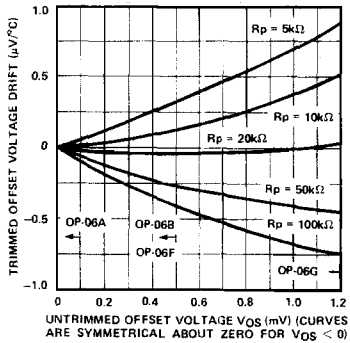
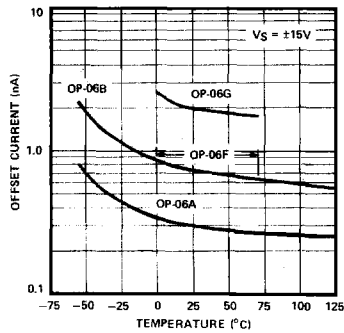
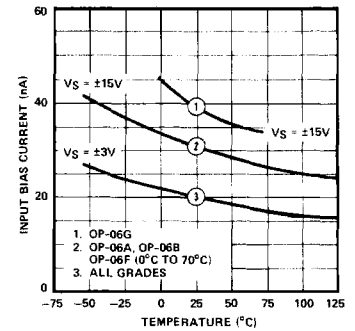
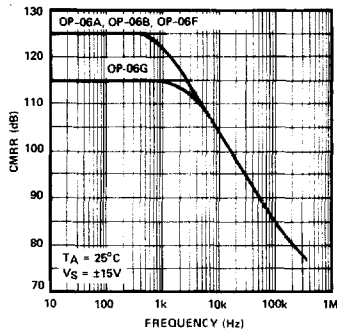
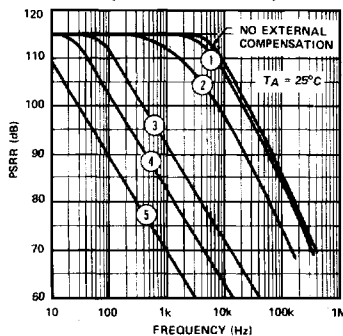
TRIMMED OFFSET VOLTAGE vs TEMPERATURE

OFFSET VOLTAGE vs TEMPERATURE

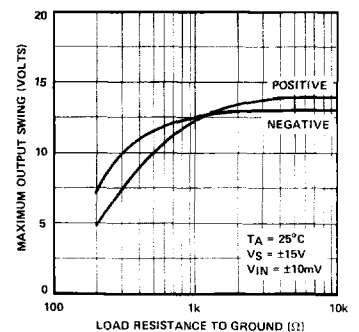
OFFSET VOLTAGE DRIFT WITH TIME

TRIMMED OFFSET VOLTAGE DRIFT AS A FUNCTION OF TRIMMING POTENTIOMETER (R_p) SIZE AND V_{OS}

OFFSET CURRENT vs TEMPERATURE

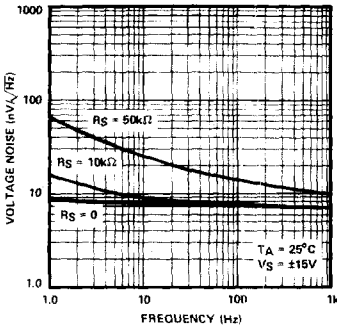
INPUT BIAS CURRENT vs TEMPERATURE

CMRR vs FREQUENCY

PSRR vs FREQUENCY (OP-06B, OP-06E)

1. C₁ = 0.001µF, R₁ = 470Ω FROM PIN 5 TO V₋
2. C₁ = 0.1µF, R₁ = 5Ω TO V₋
3. C₁ = 0.001µF, R₁ = 470Ω FROM PIN 5 TO GND
4. C₁ = 0.05µF, R₁ = 10Ω, C₂ = 0.02µF, R₂ = 39Ω TO V₋
5. C₁ = 0.05µF, R₁ = 10Ω, C₂ = 0.02µF, R₂ = 39Ω TO GND

MAXIMUM OUTPUT VOLTAGE vs LOAD RESISTANCE

TYPICAL PERFORMANCE CHARACTERISTICS

VOLTAGE NOISE DENSITY vs FREQUENCY



INPUT WIDEBAND NOISE vs BANDWIDTH

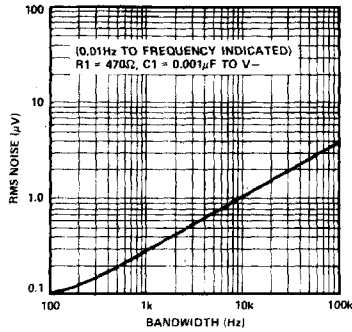

NOISE FIGURE vs SOURCE RESISTANCE

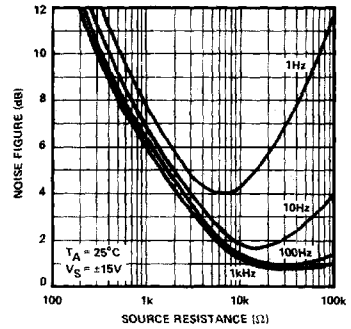

OPEN-LOOP GAIN vs TEMPERATURE

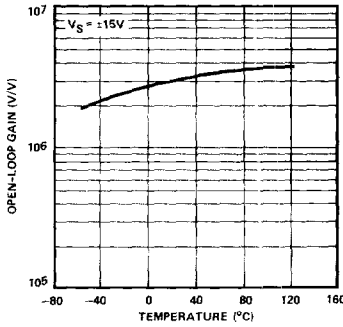

OPEN-LOOP GAIN vs SUPPLY VOLTAGE

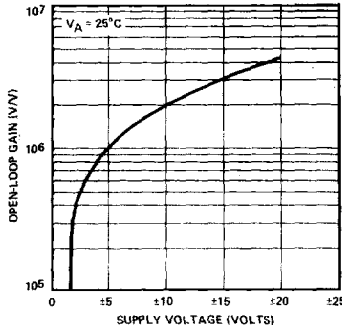

MAXIMUM OUTPUT SWING vs FREQUENCY

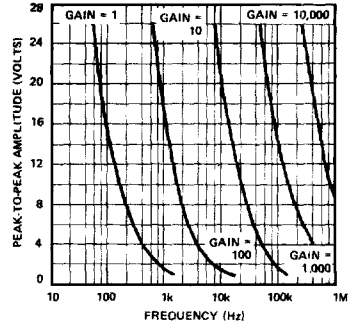

INPUT BIAS CURRENT vs DIFFERENTIAL INPUT VOLTAGE

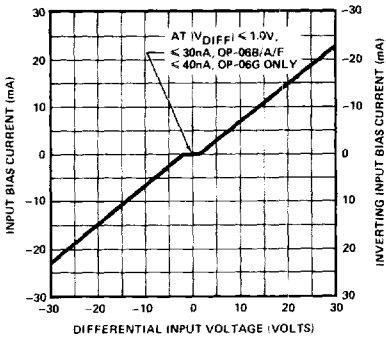

POWER CONSUMPTION vs SUPPLY VOLTAGE

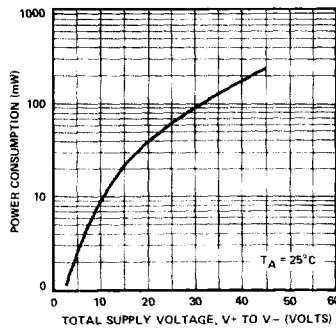

OUTPUT SHORT-CIRCUIT CURRENT

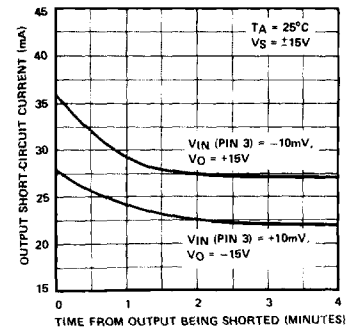

OPERATIONAL AMPLIFIERS/BUFFERS

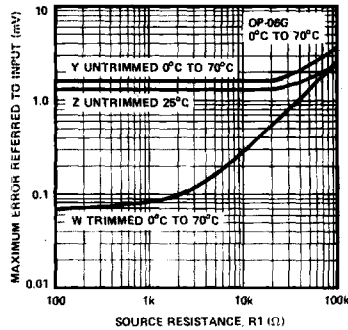
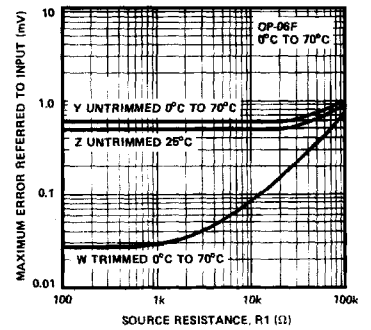
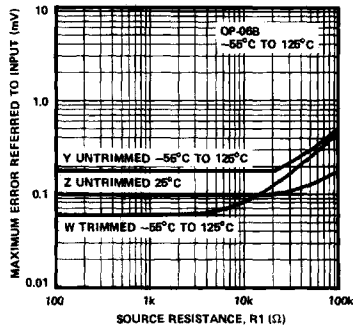
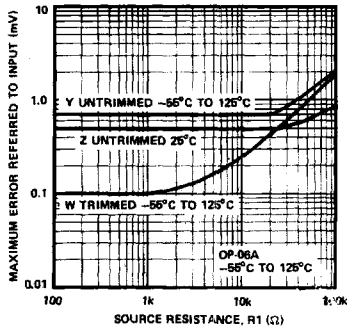
GUARANTEED PERFORMANCE CHARACTERISTICS

These graphs depict maximum error referred to the input as a function of source resistance (R_1). Curves W are shown with V_{OS} trimmed at +25°C and include errors due to V_{OS} and I_{OS} over the indicated temperature range. Curves Y and Z plot maximum errors with V_{OS} not trimmed.