

The PCIC Series encompasses all of the features of the PCIH Series in a **1U** package. Reliability, high current capacity and many system management connections make the PCIC Series ideal for use in telecom, computer, information systems and industrial applications.

PCIC SERIES CONTACT VARIANTS

FACE VIEW OF MALE AND REAR VIEW OF FEMALE

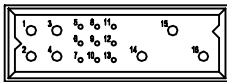

PCIC16W7 VARIANT

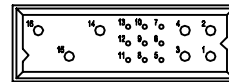

PCIC16W7R VARIANT (Inverted Termination)

7 Size 16 Power Contacts and 9 Size 22 Signal Contacts

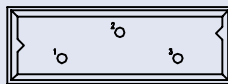

PCIC3W3 VARIANT

CREEPAGE AND CLEARANCE FOR
HIGH VOLTAGE APPLICATIONS

3 Size 16 Power Contacts





Positronic Industries
connectpositronic.com

TECHNICAL CHARACTERISTICS

Compact
Power
Connectors

MATERIALS AND FINISHES:

Insulator:	Glass-filled polyester, UL 94V-0, blue color.
Contacts:	Size 16 contacts: High conductivity precision-machined copper alloy. Size 22 contacts: Precision-machined copper alloy. Plating: gold flash over nickel. Other plating options available, refer to Step 7 on page 101.
Mounting Screws:	Steel, zinc plated.
Jackscrews:	Stainless steel, passivated.

ELECTRICAL CHARACTERISTICS:

PCIC Contact Current Ratings, per UL 1977

See *Temperature Rise Curves* on page 6 for details.

PCIC3W3:

Size 16 Power Contacts:	32 amperes continuous, all contacts under load.
-------------------------	---

PCIC16W7:

Size 16 Power Contacts:	
Positions 14, 15, and 16:	40 amperes continuous, all contacts under load.
Positions 1 through 4:	30 amperes continuous, all contacts under load.
Size 22 Signal Contacts:	3 amperes nominal rating.

Initial Contact Resistance; maximum:

Size 16 Contact:	0.0007 ohms maximum.
Size 22 Contact:	0.004 ohms maximum. Per IEC 512-2, Test 2b.

Insulator Resistance:	5 G ohms per IEC 512-2, Test 3a.
------------------------------	----------------------------------

Voltage Proof:

PCIC3W3:	5,000 V r.m.s.
PCIC16W7:	
Contacts 14, 15, and 16:	3,000 V r.m.s.
Contacts 1 through 4:	1,500 V r.m.s.
Contacts 5 through 13:	1,000 V r.m.s.

Creepage and Clearance

Distance; minimum:	
PCIC3W3:	7.23mm [0.285 inch]
PCIC16W7:	
Contact 16 to Contact 14:	3.2mm [0.126 inch]
Contact 15 to Contact 14:	3.2mm [0.126 inch]
Contact 16 to Signal Contacts:	6.4mm [0.252 inch]
Contact 15 to Signal Contacts:	6.4mm [0.252 inch]
Contact 16 to Contact 15:	2.5mm [0.098 inch]
Contact 14 to Signal Contacts:	2.0mm [0.079 inch]

Working Voltage:

PCIC3W3:	2,000 V r.m.s.
PCIC16W7:	
Contacts 14, 15 and 16:	1,000 V r.m.s.
Contacts 1 through 4:	500 V r.m.s.
Contacts 5 through 13:	333 V r.m.s.

MECHANICAL CHARACTERISTICS:

Blind Mating System:	Male and female connector bodies provide "lead-in" for 1.3mm [0.050 inch] diametral misalignment.
Polarization:	Provided by connector body design.

Removable Contacts:

Install contact from rear of insulator; release from front of insulator. Size 16 and 22 female contacts feature "Closed Entry" design for highest reliability.

Removable Contact Retention in Connector Body:

Size 16 Contacts:	67 N [15 lbs.]
Size 22 Contacts:	27 N [6 lbs.]

Fixed Contacts:

Printed board terminations, both straight and right angle (90°). Size 16 female contacts feature "Closed Entry" design. Size 22 feature rugged "Robi-D Open Entry" contact design. "Closed Entry" contacts available, consult Technical Sales.

Fixed Contact Retention in Connector Body:

Size 16 Contacts:	45 N [10 lbs.]
Size 22 Contacts:	27 N [6 lbs.]

Resistance to Solder Heat:

260°C [500°F] for 10 seconds duration per IEC 512-6, Test 12e, 25-watt soldering iron.

Sequential Contact Mating System:

PCIC16W7:	First mate contact 14 and last mate contact position 5.
------------------	---

Consult Technical Sales for customer specified sequential mating.

Safety "Recessed in Insulator" Contacts:

The following size 16 contacts are recessed 5mm [0.197 inch] below the face of the female connector insulator per safety requirements. Contact positions 15 and 16.

PCIC16W7:

Compliant Terminations:

Size 16 and 22 contacts are available with Compliant Contact Terminations.

Printed Board Mounting:

Mounting holes provided in connector body for printed board mounting. Self-tapping screws are available.

Mechanical Operations:

250 couplings, minimum.

CLIMATIC CHARACTERISTICS:

Working Temperature:	-55°C to +125°C.
-----------------------------	------------------

U.L. Recognized File #E49351*
CSA Recognized File #LR54219*

* U.L. and CNR recognition for PCIC3W3 is pending, consult Technical Sales.



For RoHS options
see page 101.

PCIC CONNECTOR OUTLINE DIMENSIONS

RIGHT ANGLE (90°) BOARD MOUNT CONNECTOR

FEMALE CONNECTOR

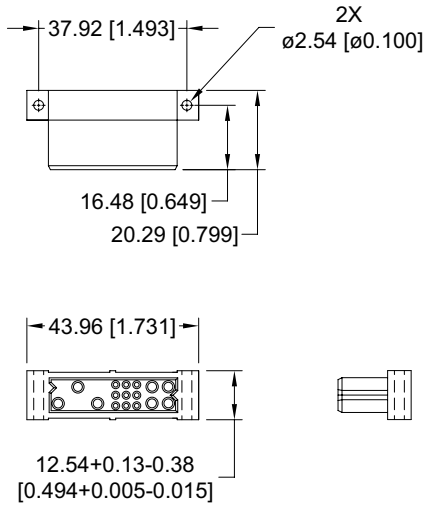

MALE CONNECTOR

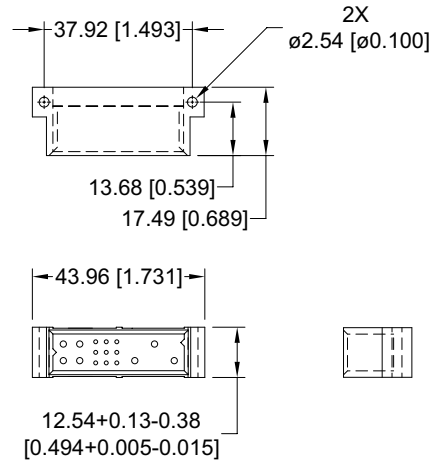

STRAIGHT BOARD MOUNT CONNECTOR

FEMALE CONNECTOR

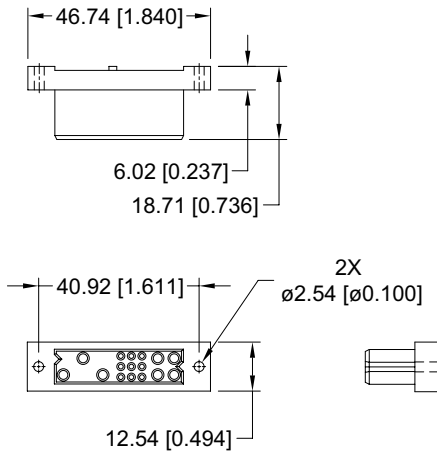

MALE CONNECTOR

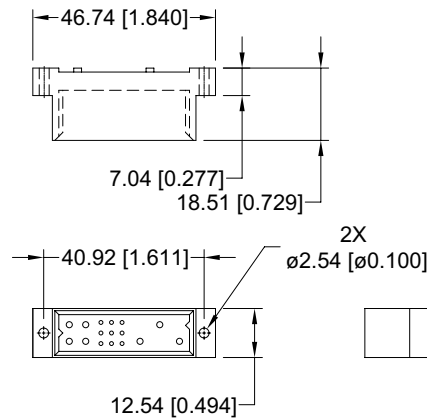

PCIC CONNECTOR MATING DIMENSIONS (FULLY MATED)

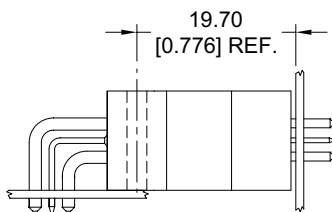

Right Angle (90°) Board
Mount Male to Straight
Board Mount or Panel
Mount Female

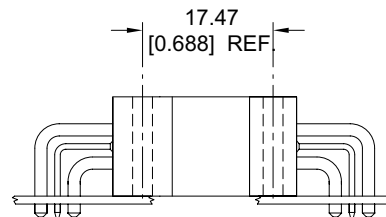

Right Angle (90°)
Board Mount Male to
Right Angle (90°)
Board Mount Female



Positronic Industries
connectpositronic.com

STRAIGHT SOLDER CONNECTOR, FEMALE

Compact
Power
Connectors

PCIC SERIES

FEMALE STRAIGHT SOLDER CONNECTOR CODE 3

STANDARD PART NUMBER
PCIC16W7F300A1

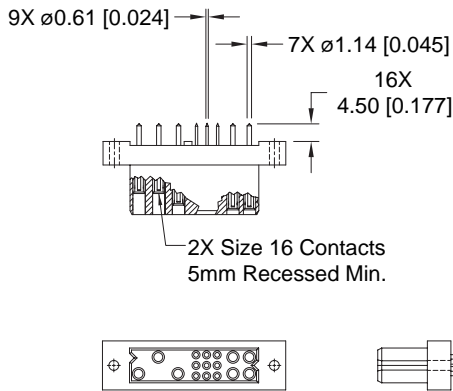

CONNECTOR DIMENSIONS

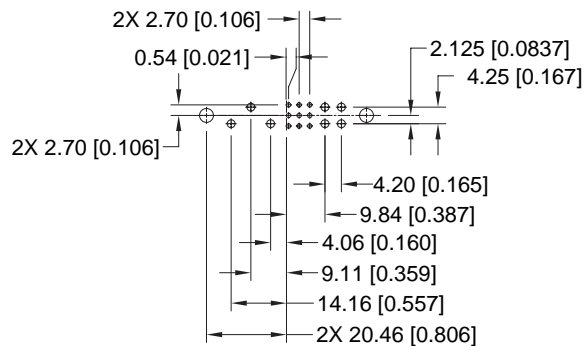

CONTACT HOLE PATTERN

Note: See below for suggested printed board hole sizes.

FEMALE STRAIGHT SOLDER CONNECTOR WITH A.C. PASS-THROUGH CODE 3 WITH MOS* -246.2

CRIMP CONTACTS ARE NOT SUPPLIED WITH CONNECTOR AND MUST BE ORDERED SEPARATELY

LOW PROFILE PART NUMBER
PCIC16W7F300A1-246.2

* For MOS descriptions,
see chart on pages 111-112.

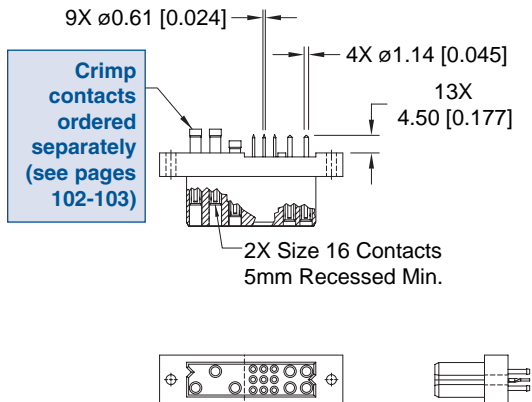

CONNECTOR DIMENSIONS

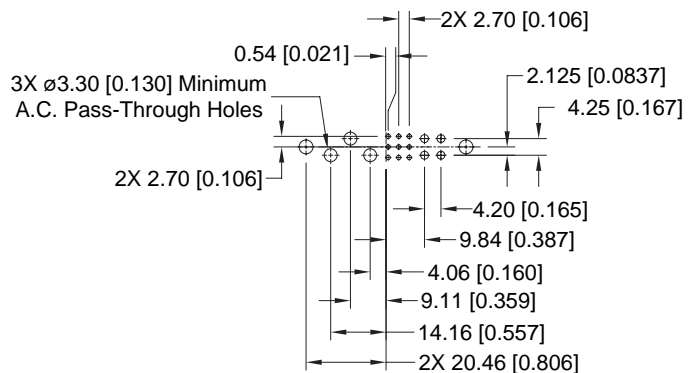

CONTACT HOLE PATTERN

SUGGESTED PRINTED BOARD HOLE SIZES:

Suggest $\varnothing 1.00$ [0.039] holes for size 22 contact holes.

Suggest $\varnothing 1.60$ [0.063] holes for size 16 contact holes.

Suggest $\varnothing 3.56 \pm 0.08$ [0.140 \pm 0.003] holes for connector mounting holes.

MALE STRAIGHT SOLDER CONNECTOR
CODE 3

STANDARD PART NUMBER
PCIC16W7M300A1

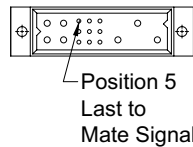
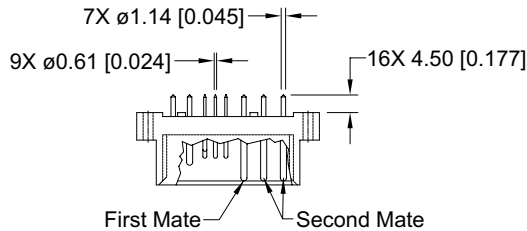

CONNECTOR DIMENSIONS

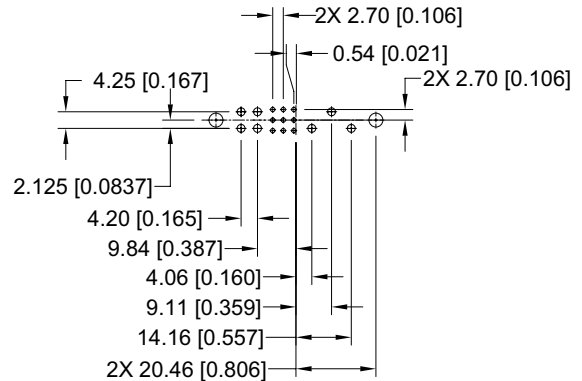

CONTACT HOLE PATTERN

Note: See below for suggested printed board hole sizes.



MALE STRAIGHT SOLDER CONNECTOR WITH JACKSCREW SYSTEM
CODE 3 WITH MOS* -443.2

STANDARD PART NUMBER
PCIC3W3M300A1-443.2

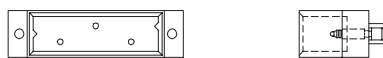
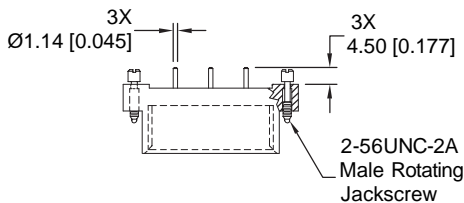

CONNECTOR DIMENSIONS

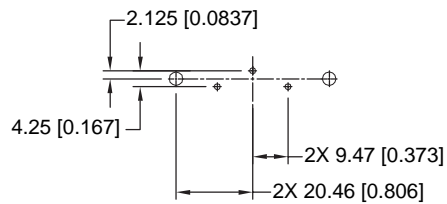

CONTACT HOLE PATTERN

* For MOS descriptions,
see chart on pages 111-112.

SUGGESTED PRINTED BOARD HOLE SIZES:

- Suggest Ø1.00 [0.039] holes for size 22 contact holes.
- Suggest Ø1.60 [0.063] holes for size 16 contact holes.
- Suggest Ø3.56±0.08 [0.140±0.003] holes for connector mounting holes.

DIMENSIONS ARE IN MILLIMETERS (INCHES).
ALL DIMENSIONS ARE SUBJECT TO CHANGE.



Positronic Industries
connectpositronic.com

RIGHT ANGLE (90°) BOARD MOUNT CONNECTOR, FEMALE

Compact
Power
Connectors

PCIC SERIES

FEMALE RIGHT ANGLE (90°) BOARD MOUNT CONNECTOR CODE 4

STANDARD PART NUMBER
PCIC16W7F400A1

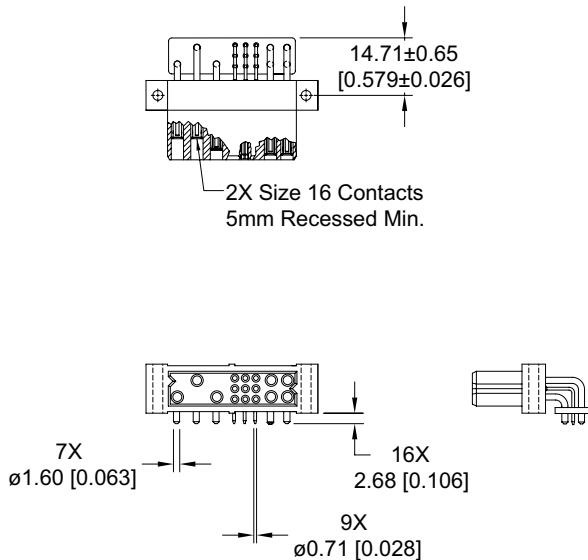

CONNECTOR DIMENSIONS

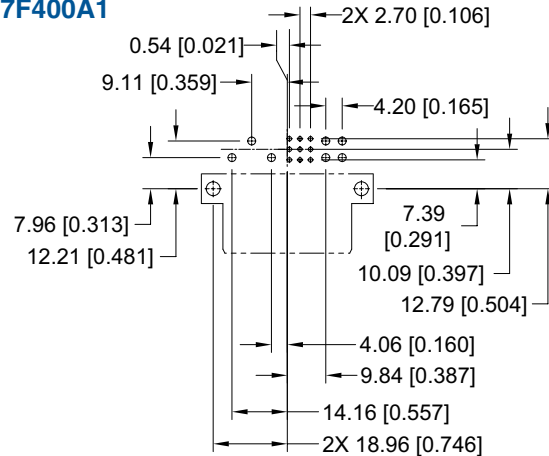

CONTACT HOLE PATTERN

Note: See below for suggested printed board hole sizes.

FEMALE RIGHT ANGLE (90°) BOARD MOUNT CONNECTOR CODE 4

PART NUMBER FOR INVERTED TERMINATION
PCIC16W7RF400A1

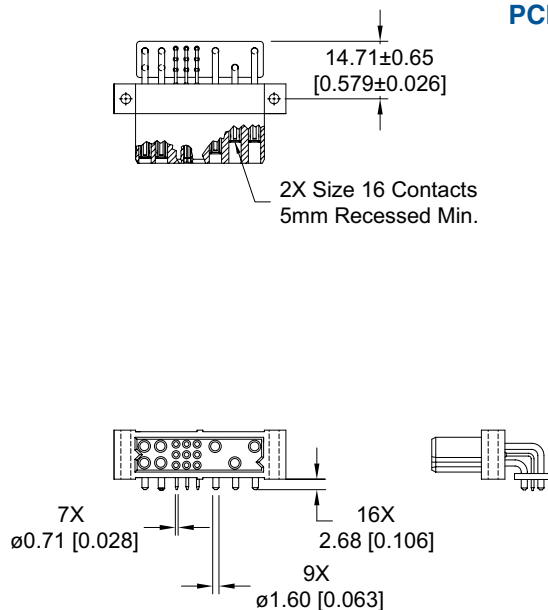

CONNECTOR DIMENSIONS

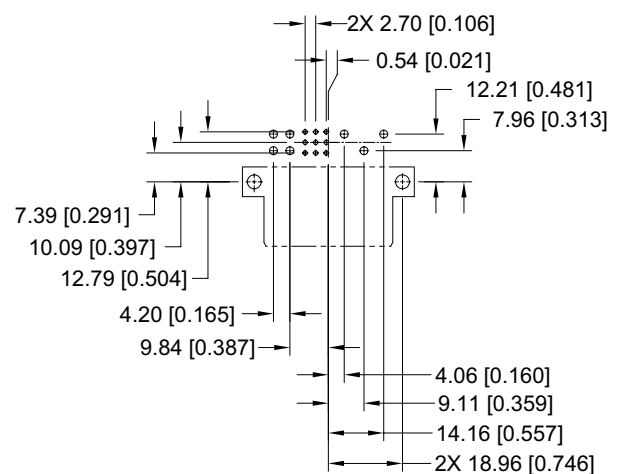

CONTACT HOLE PATTERN

SUGGESTED PRINTED BOARD HOLE SIZES:

Suggest $\phi 1.14$ [0.045] holes for size 22 contact holes.

Suggest $\phi 2.03$ [0.080] holes for size 16 contact holes.

Suggest $\phi 3.56 \pm 0.08$ [0.140 ± 0.003] holes for connector mounting holes.

**MALE RIGHT ANGLE (90°) BOARD MOUNT CONNECTOR
CODE 4**

**STANDARD PART NUMBER
PCIC16W7M400A1**

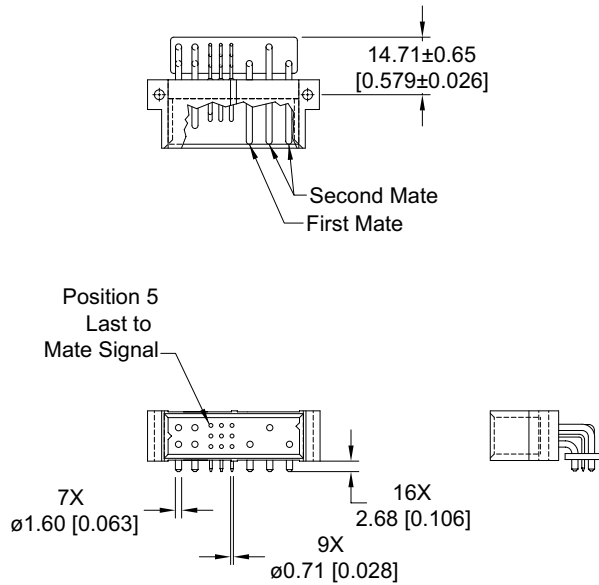

CONNECTOR DIMENSIONS

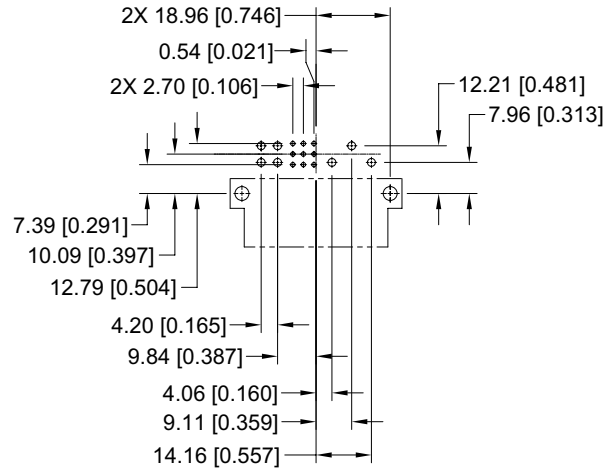

CONTACT HOLE PATTERN

Note: See below for suggested printed board hole sizes.

**MALE RIGHT ANGLE (90°) BOARD MOUNT CONNECTOR
CODE 4**

**PART NUMBER FOR INVERTED TERMINATION
PCIC16W7RM400A1**

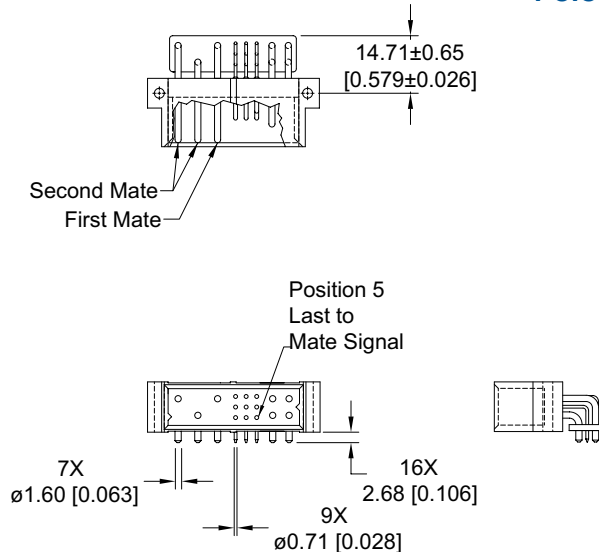

CONNECTOR DIMENSIONS

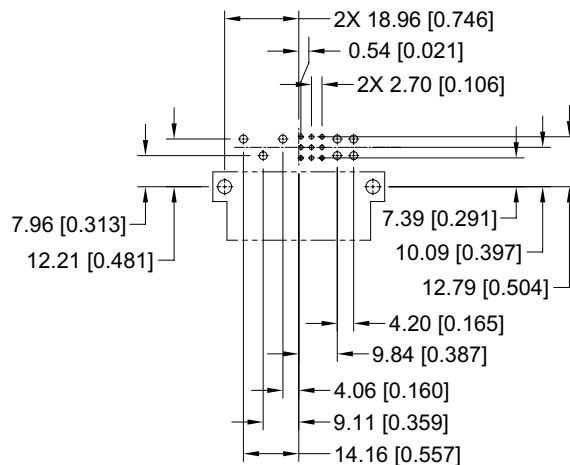

CONTACT HOLE PATTERN

SUGGESTED PRINTED BOARD HOLE SIZES:

- Suggest Ø1.14 [0.045] holes for size 22 contact holes.
- Suggest Ø2.03 [0.080] holes for size 16 contact holes.
- Suggest Ø3.56±0.08 [0.140±0.003] holes for connector mounting holes.



Positronic Industries
connectpositronic.com

PANEL MOUNT CONNECTOR. FEMALE

Compact
Power
Connectors

PCIC SERIES

FEMALE PANEL MOUNT CRIMP CONTACT CONNECTOR CODE 8

CONTACTS ARE NOT SUPPLIED WITH CONNECTOR AND MUST BE ORDERED SEPARATELY

STANDARD PART NUMBER
PCIC16W7F8000

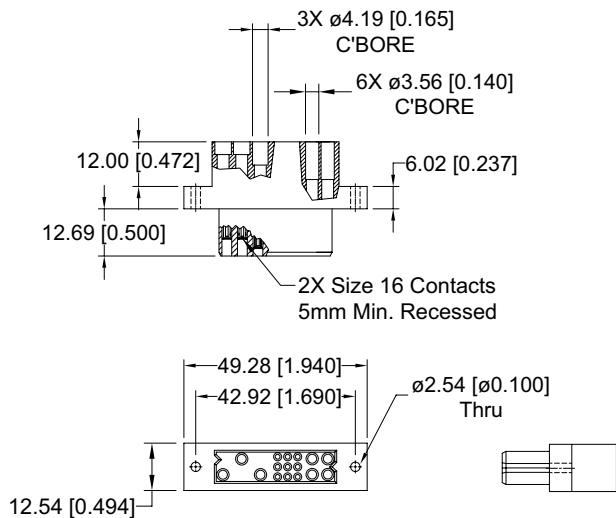

CONNECTOR DIMENSIONS

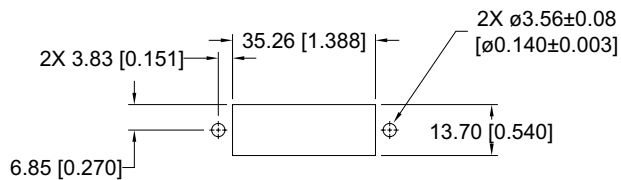

PANEL CUT OUT

For information regarding removable contacts, see Removable Contact section, pages 102-103.

FEMALE COMPLIANT PRESS-FIT CONNECTOR CODE 93 OR 94

STANDARD PART NUMBER
PCIC16W7F9300A1
PCIC16W7F9400A1

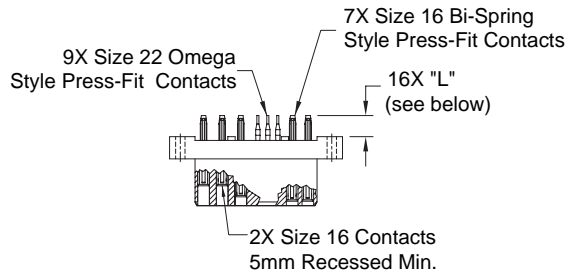

CONNECTOR DIMENSIONS

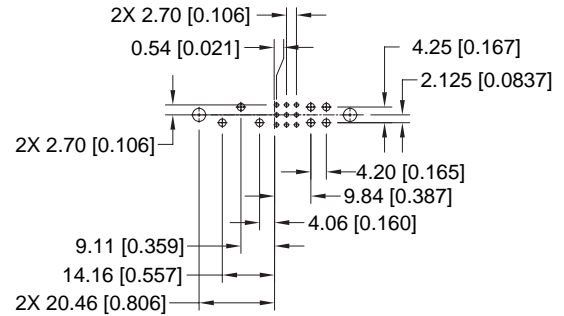

CONTACT HOLE PATTERN

CONTACT TAIL LENGTH		
Code	"L" Length	Board Thickness
93	5.72 [0.225]	2.29 to 4.45 [0.090 to 0.175]
94	7.04 [0.277]	4.45 min. [0.175 min.]

Note: See below for suggested printed board hole sizes, press-fit connector installation tools, and mounting screw options.

FEMALE COMPLIANT PRESS-FIT CONNECTOR WITH A.C. PASS-THROUGH CODE 93 OR 94 WITH MOS* -246.2

CRIMP CONTACTS ARE NOT SUPPLIED WITH CONNECTOR AND MUST BE ORDERED SEPARATELY

LOW PROFILE PART NUMBER
PCIC16W7F9300A1-246.2
PCIC16W7F9400A1-246.2

* For MOS descriptions, see chart on pages 111-112.

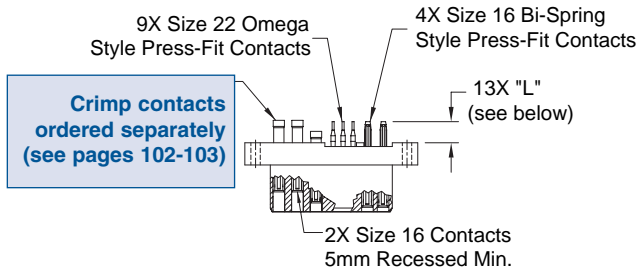

CONNECTOR DIMENSIONS

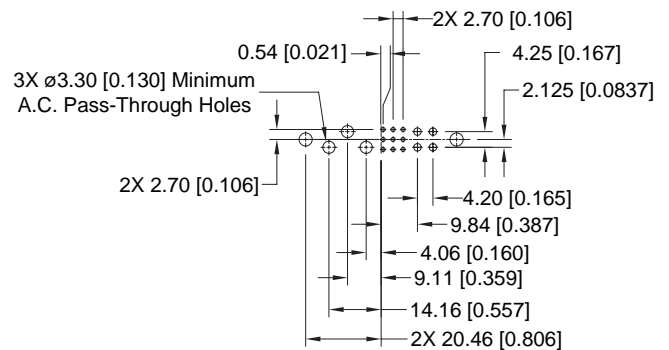

CONTACT HOLE PATTERN

SUGGESTED PRINTED BOARD HOLE SIZES:

Suggest $\varnothing 3.56 \pm 0.08$ [0.140 \pm 0.003] holes for connector mounting holes.

NOTE: See page 110 for suggested printed board drill hole sizes, recommended plating and finished hole sizes for compliant contact termination positions.

For press-fit connector installation tools, see pages 108-109.

For mounting screw options, see page 108.

CONTACT TAIL LENGTH		
Code	"L" Length	Board Thickness
93	5.72 [0.225]	2.29 to 4.45 [0.090 to 0.175]
94	7.04 [0.277]	4.45 min. [0.175 min.]

DIMENSIONS ARE IN MILLIMETERS [INCHES].
ALL DIMENSIONS ARE SUBJECT TO CHANGE.



Positronic Industries
connectpositronic.com

COMPLIANT PRESS-FIT BOARD MOUNT CONNECTOR, FEMALE

Compact
Power
Connectors



FEMALE COMPLIANT PRESS-FIT CONNECTOR WITH JACKSCREW SYSTEM CODE 93 OR 94 WITH MOS* -444.2

STANDARD PART NUMBER
PCIC3W3F9300A1-444.2
PCIC3W3F9400A1-444.2

* For MOS descriptions,
see chart on pages 111-112.

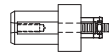
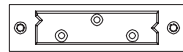
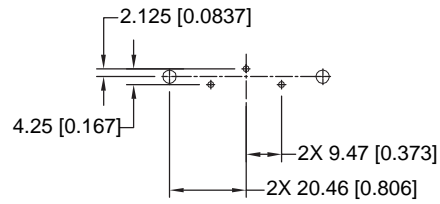
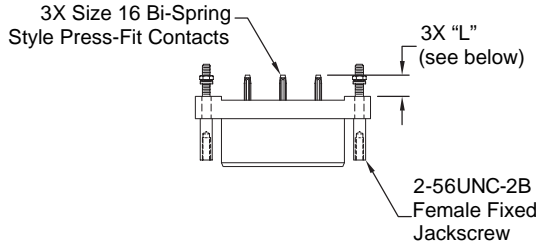

CONNECTOR DIMENSIONS

CONTACT HOLE PATTERN

CONTACT TAIL LENGTH		
Code	"L" Length	Board Thickness
93	5.72 [0.225]	2.29 to 4.45 [0.090 to 0.175]
94	7.04 [0.277]	4.45 min. [0.175 min.]

SUGGESTED PRINTED BOARD HOLE SIZES:

Suggest $\varnothing 3.56 \pm 0.08$ [0.140 \pm 0.003] holes for connector mounting holes.

NOTE: See page 110 for suggested printed board drill hole sizes, recommended plating and finished hole sizes for compliant contact termination positions.

For press-fit connector installation tools, see pages 108-109.

For mounting screw options, see page 108.

MALE COMPLIANT PRESS-FIT CONNECTOR CODE 93 OR 94

STANDARD PART NUMBER
PCIC16W7M9300A1
PCIC16W7M9400A11

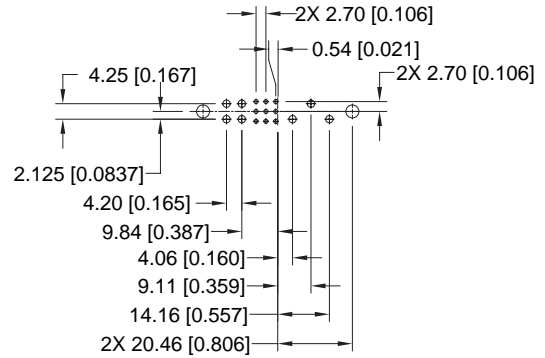
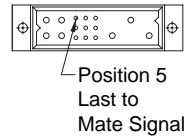
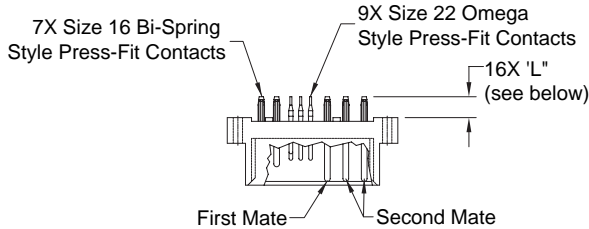

CONTACT HOLE PATTERN

CONNECTOR DIMENSIONS

CONTACT TAIL LENGTH		
Code	"L" Length	Board Thickness
93	5.72 [0.225]	2.29 to 4.45 [0.090 to 0.175]
94	7.04 [0.277]	4.45 min. [0.175 min.]

SUGGESTED PRINTED BOARD HOLE SIZES:

Suggest $\varnothing 3.56 \pm 0.08$ [0.140 \pm 0.003] holes for connector mounting holes.

NOTE: See page 110 for suggested printed board drill hole sizes, recommended plating and finished hole sizes for compliant contact termination positions.

For press-fit connector installation tools, see pages 108-109.

For mounting screw options, see page 108.



Positronic Industries
connectpositronic.com

PCIC ORDERING INFORMATION

Compact
Power
Connectors

ORDERING INFORMATION - CODE NUMBERING SYSTEM

Specify Complete Connector By Selecting An Option From Step 1 Through 7

STEP	1	2	3	4	5	6	7	8	9
EXAMPLE	PCIC	16W7	F	93	0	0	A1	/AA	

STEP 1 - BASIC SERIES

PCIC - PCIC Series

STEP 2 - CONNECTOR VARIANTS

16W7 - 7 size 16 contacts and 9 size 22 contacts

16W7R - 7 size 16 contacts and 9 size 22 contacts. Inverted termination style, use with contact type "4".

*3W3 - 3 size 16 contacts

STEP 3 - CONNECTOR GENDER

F - Female
M - Male

STEP 4 - CONTACT TERMINATION TYPE

- 3 - Solder, Straight Printed Board Mount with 4.50 [0.177] tail extension for connection systems 1 and 2.
- 4 - Solder, Right Angle (90°) Printed Board Mount with 2.68 [0.106] tail extension for connection systems 1 and 4.
- 8 - Contacts must be ordered separately for Panel Mount Cable Connectors, connection system 3, see pages 102-103. Female connector only.
- 93 - Press-Fit, Compliant Termination size 16 and size 22 Straight Printed Board Mount for use with board thicknesses of 2.29 to 4.45 [0.090 to 0.175]. Connection system 1.
- 94 - Press-Fit, Compliant Termination size 16 and size 22 Straight Printed Board Mount for use with board thickness of 4.45 minimum [0.175 minimum]. Connection systems 1 and 2.

STEP 5 - MOUNTING STYLE

0 - Standard Option

See page 108 for mounting screw options.

STEP 6 - HOODS

0 - Not applicable

* PCIC3W3 variant only available in these part numbers: PCIC3W3F9300A1-444.2 and PCIC3W3M300A1-443.2. Consult Technical Sales for other options to this variant.

STEP 9 - SPECIAL OPTIONS

FOR LISTING OF SPECIAL OPTIONS,
SEE SPECIAL OPTIONS APPENDIX ON
PAGES 111 AND 112.



STEP 8 - ENVIRONMENTAL COMPLIANCE OPTIONS

/AA - Compliant per EU Directive 2002/95/EC (RoHS)

NOTE: If compliance to environmental legislation is not required, this step will not be used.
Example: PCIC16W7F9300A1

STEP 7 - CONTACT PLATING FOR PRINTED BOARD TYPE CONNECTORS

- 0 - Crimp contacts ordered separately
- A1 - Gold flash over nickel on mating end and termination end.
- A2 - Gold flash over nickel on mating end and 5.00 microns [0.00020 inch] tin-lead solder coat on termination end. Not available with code 93 or code 94 in step 4.
- C1 - 0.76 microns [0.000030 inch] gold over nickel on mating end and termination end.
- C2 - 0.76 microns [0.000030 inch] gold over nickel on mating end and 5.00 microns [0.00020 inch] tin-lead solder coat on termination end. Not available with code 93 or code 94 in step 4.
- D1 - 1.27 microns [0.000050 inch] gold over nickel on mating end and termination end.
- D2 - 1.27 microns [0.000050 inch] gold over nickel on mating end and 5.00 microns [0.00020 inch] tin-lead solder coat on termination end. Not available with code 93 or code 94 in step 4.

NOTE: Once you have made a connector selection, contact Technical Sales if you would like to receive a drawing in DXF, PDF format or a 3-dimensional IGES file.



SK Drawing

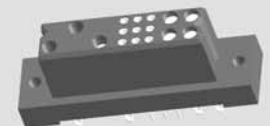

3-dimensional model