

### Features

- Guard Ring Die Construction for Transient Protection
- Ideally Suited for Automatic Assembly
- Low Power Loss, High Efficiency
- Surge Overload Rating to 50A Peak
- For Use in Low Voltage, High Frequency Inverters, Free Wheeling, and Polarity Protection Application
- High Temperature Soldering: 260°C/10 Second at Terminal
- **Available in Lead Free Finish/RoHS Compliant Version (Note 3)**

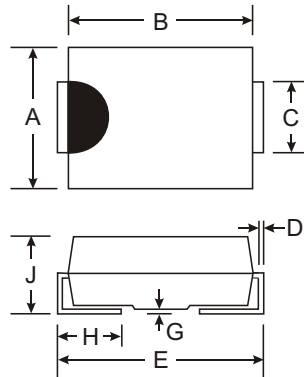

Dim	SMA		SMB	
	Min	Max	Min	Max
A	2.29	2.92	3.30	3.94
B	4.00	4.60	4.06	4.57
C	1.27	1.63	1.96	2.21
D	0.15	0.31	0.15	0.31
E	4.80	5.59	5.00	5.59
G	0.10	0.20	0.10	0.20
H	0.76	1.52	0.76	1.52
J	2.01	2.30	2.00	2.40
<b>All Dimensions in mm</b>				

### Mechanical Data

- Case: SMA/SMB
- Case Material: Molded Plastic. UL Flammability Classification Rating 94V-0
- Moisture Sensitivity: Level 1 per J-STD-020C
- Terminals: Solder Plated Terminal - Solderable per MIL-STD-202, Method 208
- Also Available in Lead Free Plating (Matte Tin Finish). Please See Ordering Information, Note 5, on Page 2
- Polarity: Cathode Band or Cathode Notch
- Marking: Type Number
- Approximate Weight: SMA 0.064 grams  
SMB 0.093 grams

No Suffix Designates SMB Package  
"A" Suffix Designates SMA Package

### Maximum Ratings and Electrical Characteristics @ T<sub>A</sub> = 25°C unless otherwise specified

Single phase, half wave, 60Hz, resistive or inductive load.  
For capacitive load, derate current by 20%.

Characteristic	Symbol	B220/A	B230/A	B240/A	B250/A	B260/A	Unit
Peak Repetitive Reverse Voltage Working Peak Reverse Voltage DC Blocking Voltage	V <sub>RRM</sub> V <sub>RWM</sub> V <sub>R</sub>	20	30	40	50	60	V
RMS Reverse Voltage	V <sub>R(RMS)</sub>	14	21	28	35	42	V
Average Rectified Output Current @ T <sub>T</sub> = 100°C	I <sub>O</sub>	2.0					A
Non-Repetitive Peak Forward Surge Current, 8.3ms single half sine-wave superimposed on rated load (JEDEC Method)	I <sub>FSM</sub>	50					A
Forward Voltage @ I <sub>F</sub> = 2.0A	V <sub>FM</sub>	0.50			0.70		V
Peak Reverse Current @ T <sub>A</sub> = 25°C @ T <sub>A</sub> = 100°C	I <sub>RM</sub>	0.5 20					mA
Typical Total Capacitance (Note 2)	C <sub>T</sub>	200					pF
Typical Thermal Resistance, Junction to Terminal	R <sub>θJT</sub>	20					°C/W
Typical Thermal Resistance, Junction to Ambient (Note 1)	R <sub>θJA</sub>	25					°C/W
Operating and Storage Temperature Range	T <sub>J</sub> , T <sub>STG</sub>	-65 to +150					°C

- Notes: 1. Thermal Resistance: Junction to terminal, unit mounted on PC board with 5.0 mm<sup>2</sup> (0.013 mm thick) copper pad as heat sink.  
2. Measured at 1.0 MHz and applied reverse voltage of 4.0V DC.  
3. RoHS revision 13.2.2003. Glass and High Temperature Solder Exemptions Applied, see *EU Directive Annex Notes 5 and 7*.

**Ordering Information** (Note 4 & 5)

Device*	Packaging	Shipping
B2xxA-13 B2xx-13	SMA SMB	5000/Tape & Reel 3000/Tape & Reel

\* x = Device type, e.g. B260A-13 (SMA package); B240-13 (SMB package).

- Notes:
4. For Packaging Details, go to our website at <http://www.diodes.com/datasheets/ap02007.pdf>.
  5. For Lead Free Finish/RoHS Compliant version part number, please add "-F" suffix to the part number above. Example: B250-13-F.

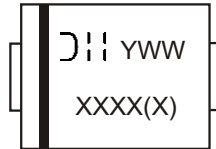

XXXX = Product type marking code, ex: B220A (SMA package)  
 XXXX = Product type marking code, ex: B230 (SMB package)  
 D||| = Manufacturers' code marking  
 YWW = Date code marking  
 Y = Last digit of year ex: 2 for 2002  
 WW = Week code 01 to 52

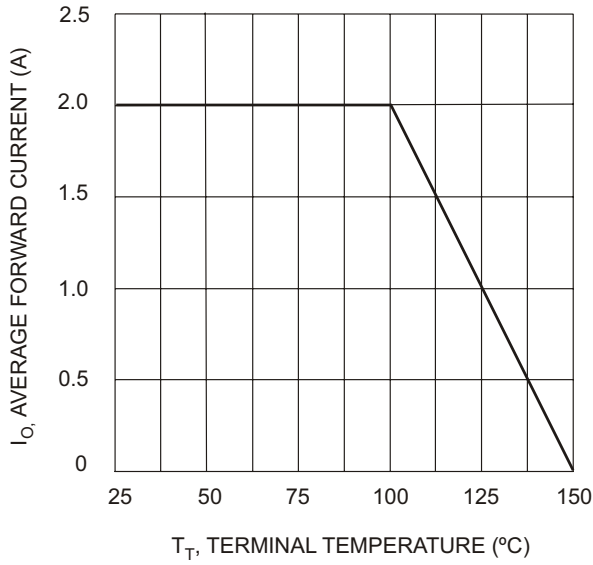

Fig. 1 Forward Current Derating Curve

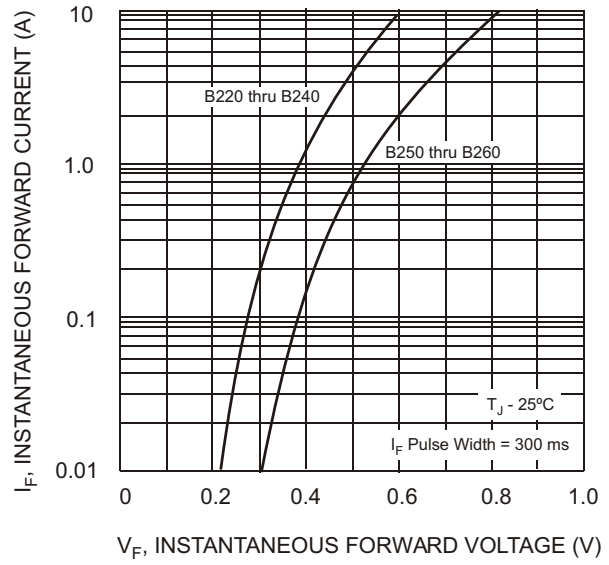

Fig. 2 Typical Forward Characteristics

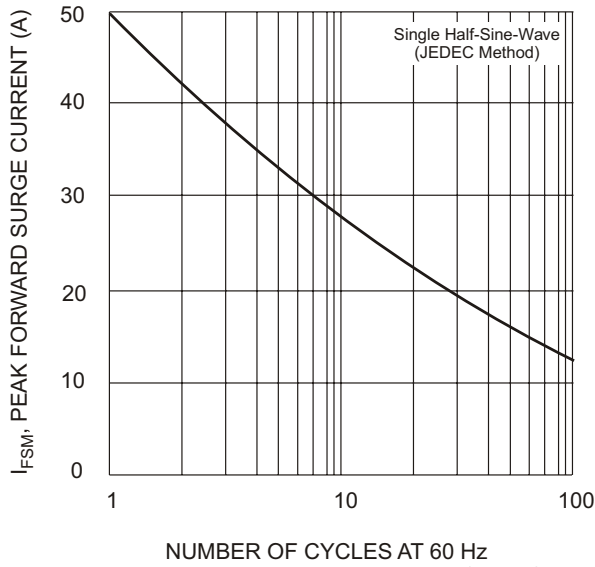

Fig. 3 Max Non-Repetitive Peak Forward Surge Current

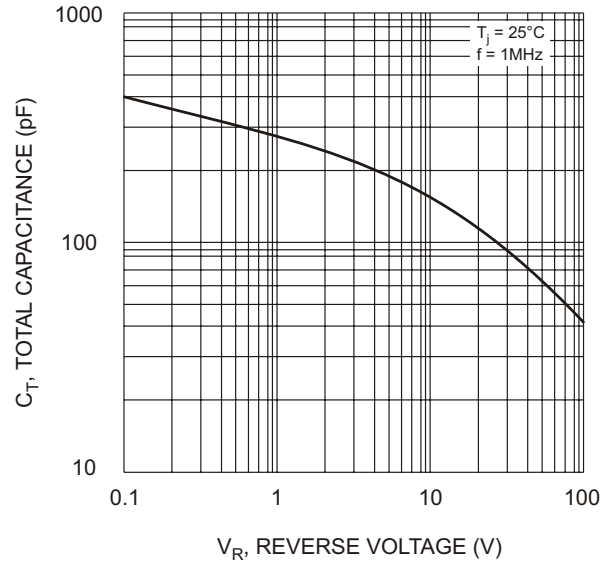

Fig. 4 Typical Total Capacitance

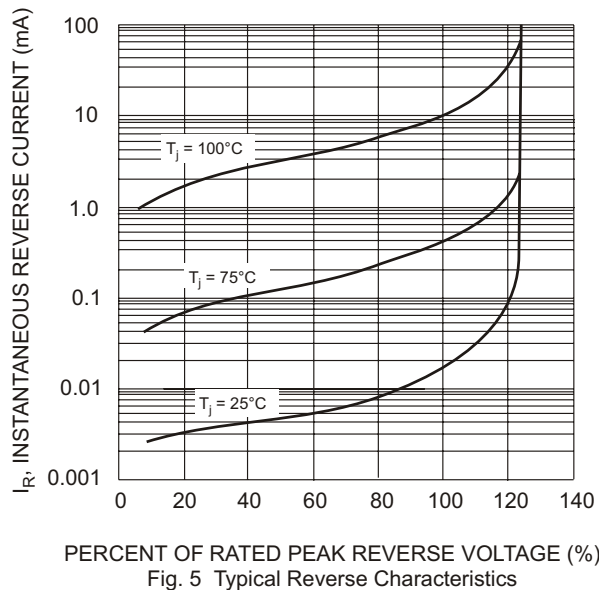

Fig. 5 Typical Reverse Characteristics