

Resistor LED for 12 V Supply Voltage

Color	Type	Technology	Angle of Half Intensity $\pm\varphi$
High efficiency red	TLRH4400	GaAsP on GaP	30°
Soft orange	TLRO4400	GaAsP on GaP	30°
Yellow	TLRY4400	GaAsP on GaP	30°
Green	TLRG4400	GaP on GaP	30°
Pure green	TLRP440.	GaP on GaP	30°

Description

These devices are developed for the automotive industry and other industries which use 12 V sources. The TLR.440. series contains an integrated resistor for current limiting in series with the LED chip. This allows the lamp to be driven from a 12 V source without an external current limiter.

Available colors are red, soft orange, yellow, green and pure green. The luminous intensity of such an LED is measured at constant voltage of 12 V.

These tinted diffused lamps provide a wide off-axis viewing angle.

These LEDs are intended for space critical applications such as automobile instrument panels, switches and others which are driven from a 12 V source.

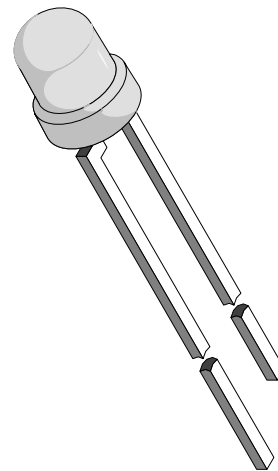

94 8488

Features

- With current limiting resistor for 12 V
- Cost effective: save space and resistor cost
- Standard \varnothing 3 mm (T-1) package
- Wide viewing angle
- Choice of five bright colors
- Luminous intensity categorized
- Yellow and green color categorized
- Luminous intensity and color are measured at 12 V



16496

Applications

Status light in cars and other applications with a 12 V source
 OFF / ON indicator in cars and other applications with a 12 V source
 Background illumination for switches
 Off / On indicator in switches

Absolute Maximum Ratings

$T_{amb} = 25^{\circ}\text{C}$, unless otherwise specified

TLRH4400 , TLRO4400 , TLR4400 , TLRG4400 , TLRP4400

Parameter	Test Conditions	Symbol	Value	Unit
Reverse voltage		V_R	6	V
Forward voltage	$T_{amb} \leq 65^{\circ}\text{C}$	V_F	16	V
Power dissipation	$T_{amb} \leq 65^{\circ}\text{C}$	P_V	240	mW
Junction temperature		T_j	100	$^{\circ}\text{C}$
Operating temperature range		T_{amb}	-40 to +100	$^{\circ}\text{C}$
Storage temperature range		T_{stg}	-55 to +100	$^{\circ}\text{C}$
Soldering temperature	$t \leq 5$ s, 2 mm from body	T_{sd}	260	$^{\circ}\text{C}$
Thermal resistance junction/ambient		R_{thJA}	150	K/W

Optical and Electrical Characteristics

$T_{amb} = 25^{\circ}\text{C}$, unless otherwise specified

High efficiency red (TLRH4400)

Parameter	Test Conditions	Type	Symbol	Min	Typ	Max	Unit
Luminous intensity	$V_F = 12$ V		I_V	1.6	4		mcd
Dominant wavelength	$V_F = 12$ V		λ_d	612		625	nm
Peak wavelength	$V_F = 12$ V		λ_p		635		nm
Angle of half intensity	$V_F = 12$ V		ϕ		± 30		deg
Forward current	$V_S = 12$ V		I_F		10	12	mA
Breakdown voltage	$I_R = 10$ μA		V_{BR}	6	20		V
Junction capacitance	$V_R = 0$, $f = 1$ MHz		C_j		50		pF

Soft orange (TLRO4400)

Parameter	Test Conditions	Type	Symbol	Min	Typ	Max	Unit
Luminous intensity	$V_F = 12$ V		I_V	4	10		mcd
Dominant wavelength	$V_F = 12$ V		λ_d	598		611	nm
Peak wavelength	$V_F = 12$ V		λ_p		605		nm
Angle of half intensity	$V_F = 12$ V		ϕ		± 30		deg
Forward current	$V_S = 12$ V		I_F		10	12	mA
Breakdown voltage	$I_R = 10$ μA		V_{BR}	6	20		V
Junction capacitance	$V_R = 0$, $f = 1$ MHz		C_j		50		pF



Yellow (TLRY4400)

Parameter	Test Conditions	Type	Symbol	Min	Typ	Max	Unit
Luminous intensity	$V_F = 12\text{ V}$		I_V	1.6	4		mcd
Dominant wavelength	$V_F = 12\text{ V}$		λ_d	581		594	nm
Peak wavelength	$V_F = 12\text{ V}$		λ_p		585		nm
Angle of half intensity	$V_F = 12\text{ V}$		ϕ		± 30		deg
Forward current	$V_S = 12\text{ V}$		I_F		10	12	mA
Breakdown voltage	$I_R = 10\ \mu\text{A}$		V_{BR}	6	20		V
Junction capacitance	$V_R = 0, f = 1\text{ MHz}$		C_j		50		pF

Green (TLRG4400)

Parameter	Test Conditions	Type	Symbol	Min	Typ	Max	Unit
Luminous intensity	$V_F = 12\text{ V}$		I_V	1.6	4		mcd
Dominant wavelength	$V_F = 12\text{ V}$		λ_d	562		575	nm
Peak wavelength	$V_F = 12\text{ V}$		λ_p		565		nm
Angle of half intensity	$V_F = 12\text{ V}$		ϕ		± 30		deg
Forward current	$V_S = 12\text{ V}$		I_F		10	12	mA
Breakdown voltage	$I_R = 10\ \mu\text{A}$		V_{BR}	6	20		V
Junction capacitance	$V_R = 0, f = 1\text{ MHz}$		C_j		50		pF

Pure green (TLRP4400)

Parameter	Test Conditions	Type	Symbol	Min	Typ	Max	Unit
Luminous intensity	$V_F = 12\text{ V}$	TLRP4400	I_V	0.63	3		mcd
		TLRP4401	I_V	1.6	4		mcd
		TLRP4406	I_V	1.6		5	mcd
Dominant wavelength	$V_F = 12\text{ V}$		λ_d	555		565	nm
Peak wavelength	$V_F = 12\text{ V}$		λ_p		555		nm
Angle of half intensity	$V_F = 12\text{ V}$		ϕ		± 30		deg
Forward current	$V_S = 12\text{ V}$		I_F		10	12	mA
Breakdown voltage	$I_R = 10\ \mu\text{A}$		V_{BR}	6	20		V
Junction capacitance	$V_R = 0, f = 1\text{ MHz}$		C_j		50		pF

Typical Characteristics ($T_{amb} = 25^{\circ}C$, unless otherwise specified)

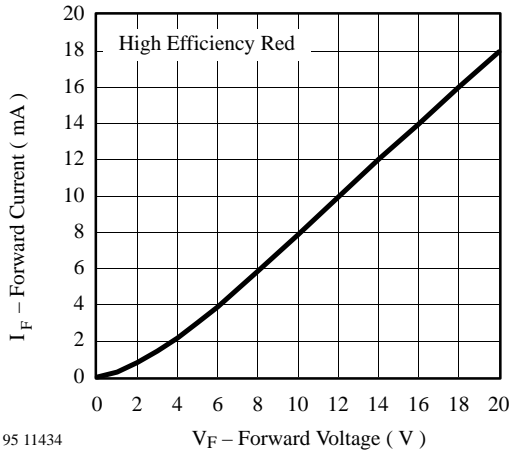

95 11434

Figure 1. Forward Current vs. Forward Voltage

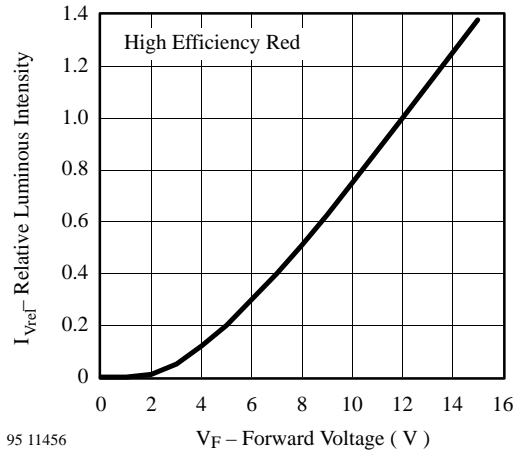

95 11456

Figure 4. Relative Luminous Intensity vs. Forward Voltage

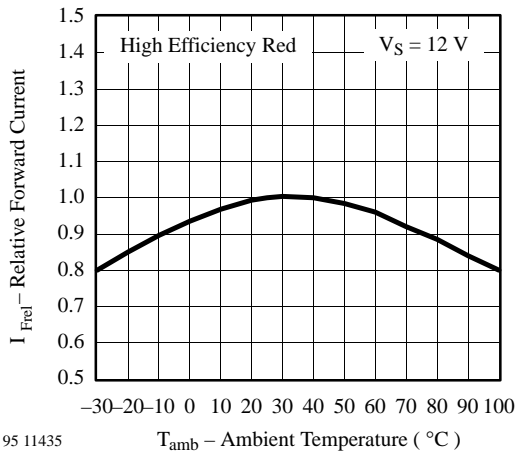

95 11435

Figure 2. Relative Forward Current vs. Ambient Temperature

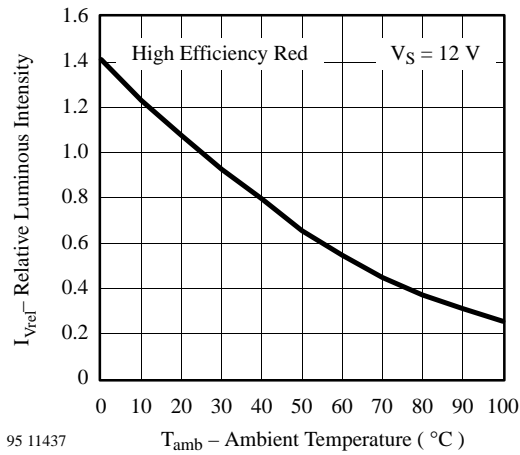

95 11437

Figure 5. Rel. Luminous Intensity vs. Ambient Temperature

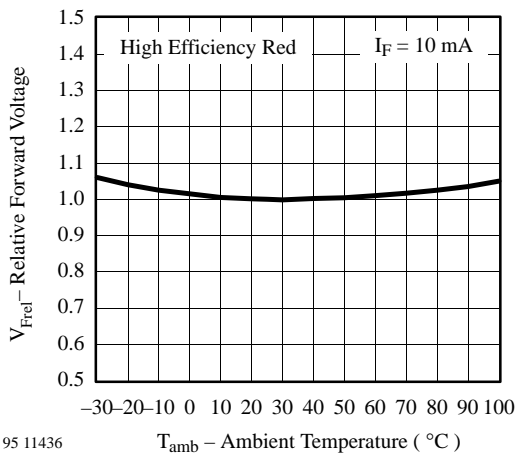

95 11436

Figure 3. Relative Forward Voltage vs. Ambient Temperature

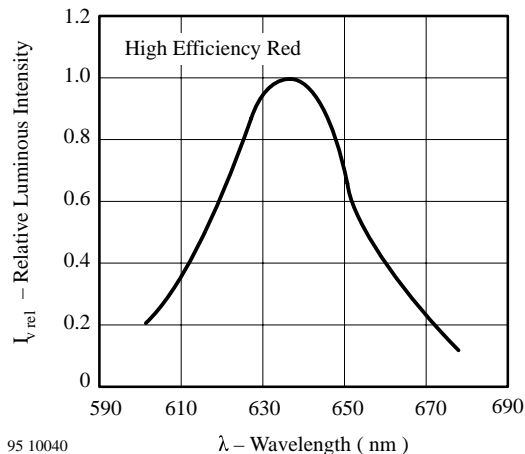

95 10040

Figure 6. Relative Luminous Intensity vs. Wavelength

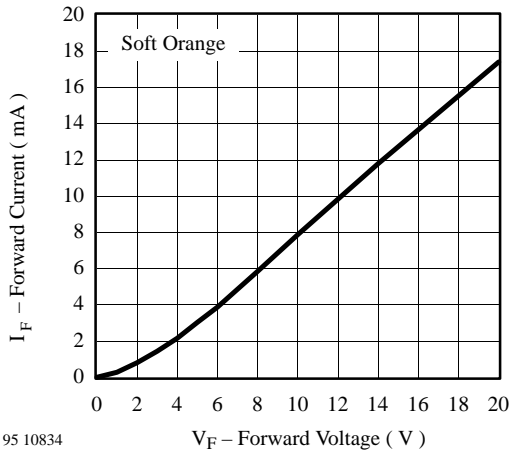

95 10834

Figure 7. Forward Current vs. Forward Voltage

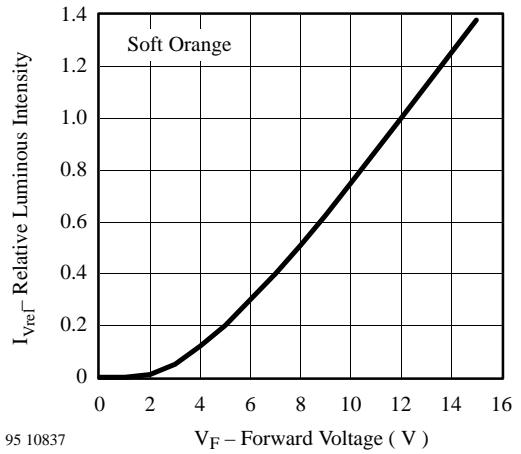

95 10837

Figure 10. Relative Luminous Intensity vs. Forward Voltage

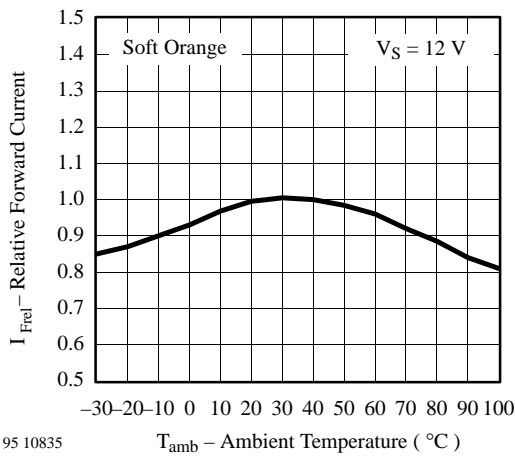

95 10835

Figure 8. Relative Forward Current vs. Ambient Temperature

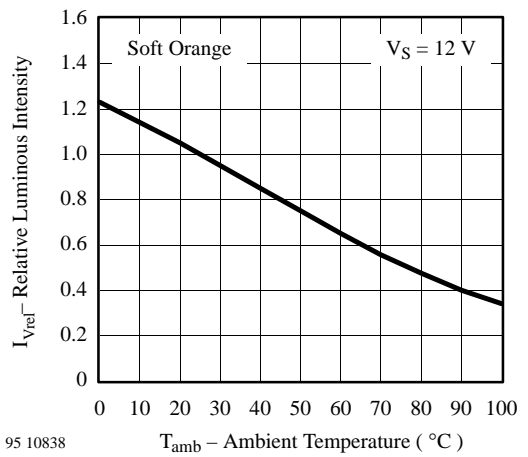

95 10838

Figure 11. Rel. Luminous Intensity vs. Ambient Temperature

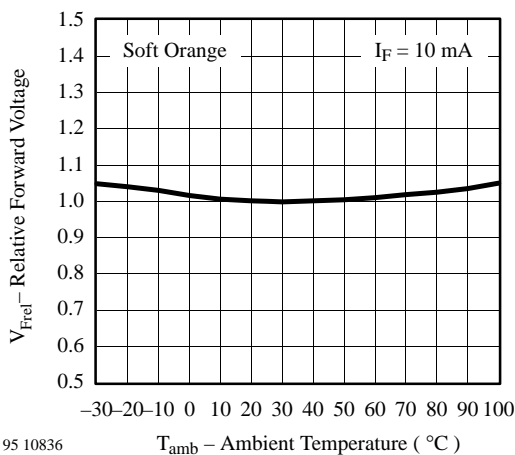

95 10836

Figure 9. Relative Forward Voltage vs. Ambient Temperature

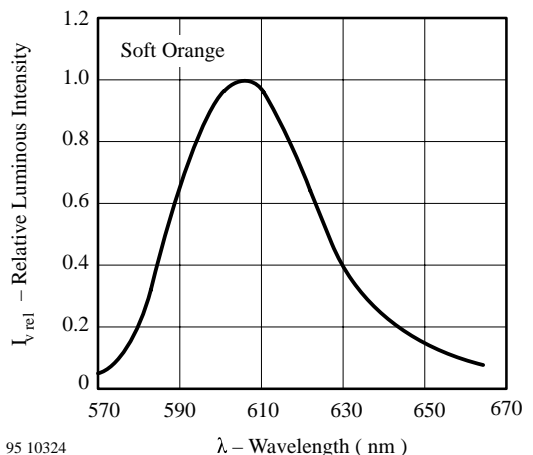

95 10324

Figure 12. Relative Luminous Intensity vs. Wavelength

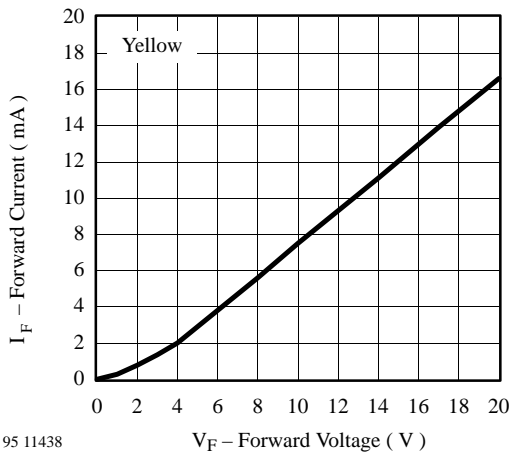

Figure 13. Forward Current vs. Forward Voltage

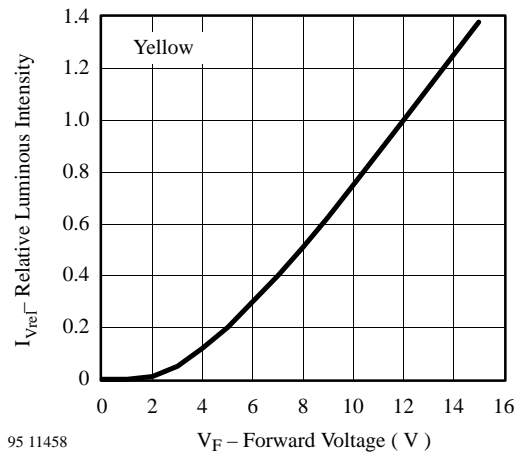

Figure 16. Relative Luminous Intensity vs. Forward Voltage

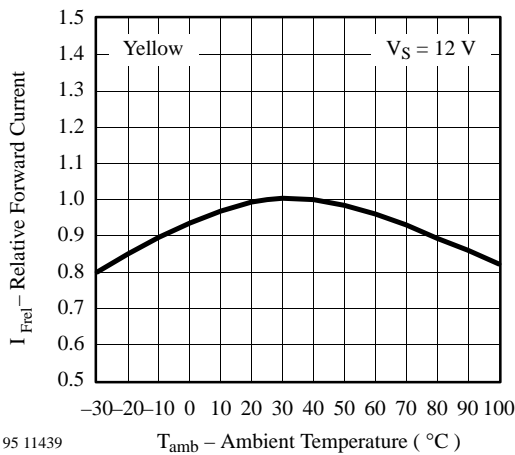

Figure 14. Relative Forward Current vs. Ambient Temperature

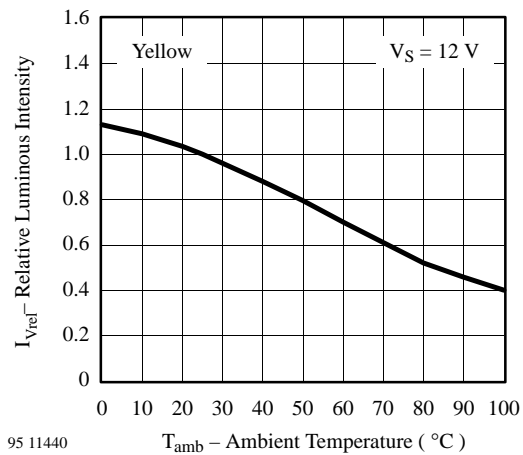

Figure 17. Rel. Luminous Intensity vs. Ambient Temperature

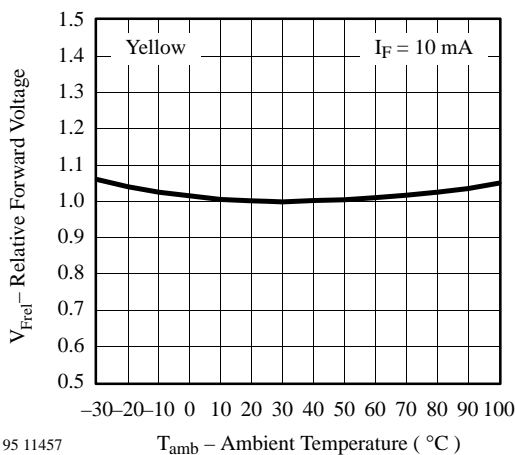

Figure 15. Relative Luminous Intensity vs. Forward Voltage

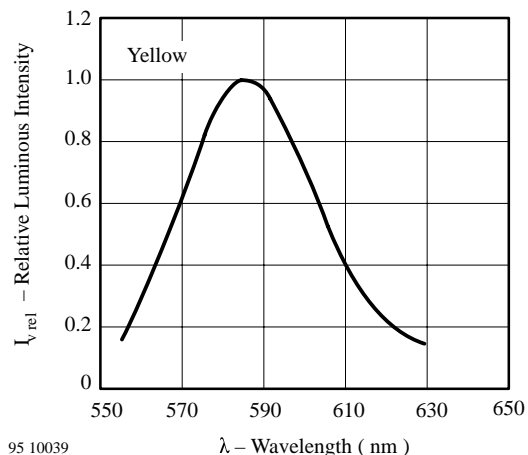
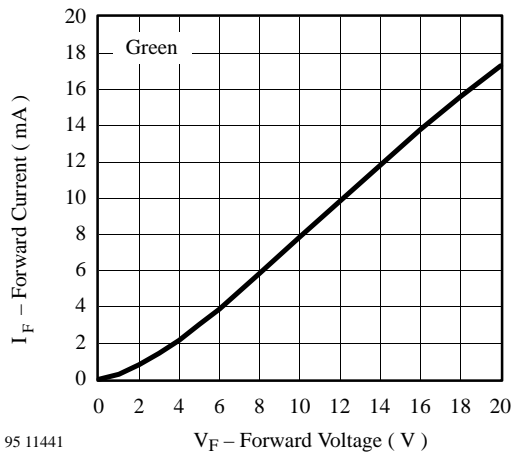
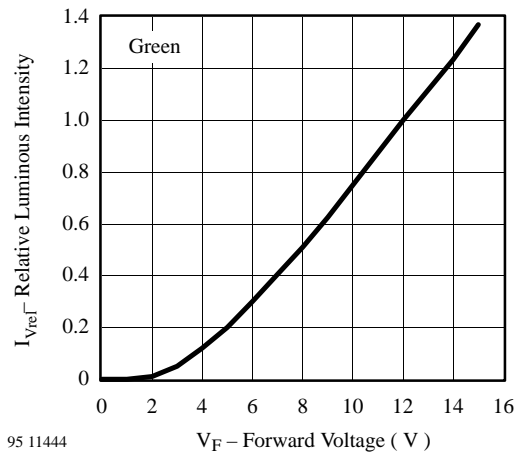

Figure 18. Relative Luminous Intensity vs. Wavelength



95 11441

Figure 19. Forward Current vs. Forward Voltage



95 11444

Figure 22. Relative Luminous Intensity vs. Forward Voltage

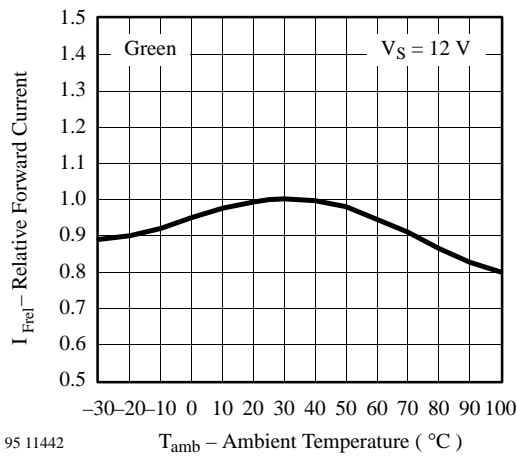

95 11442

Figure 20. Relative Forward Current vs. Ambient Temperature

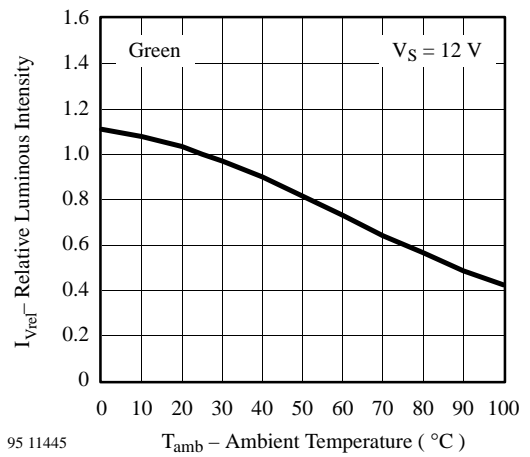

95 11445

Figure 23. Rel. Luminous Intensity vs. Ambient Temperature

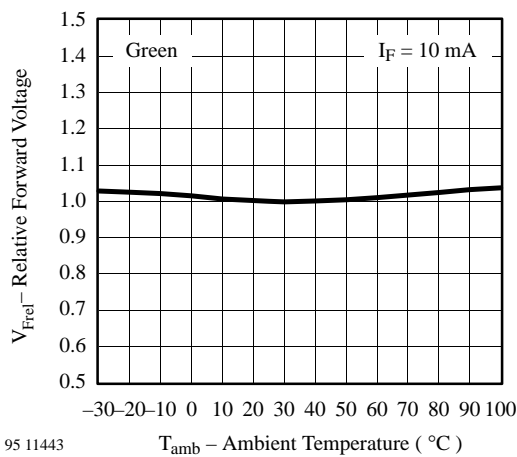

95 11443

Figure 21. Relative Forward Voltage vs. Ambient Temperature

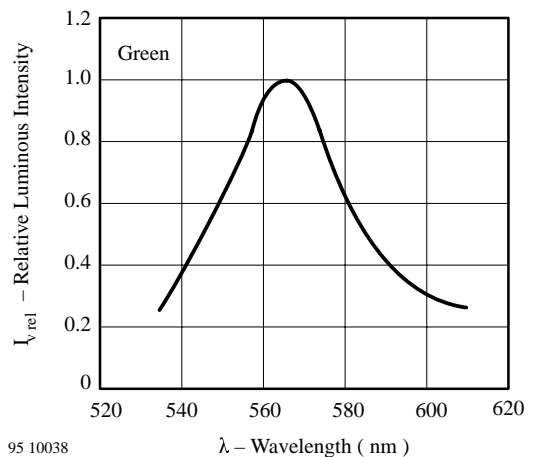

95 10038

Figure 24. Relative Luminous Intensity vs. Wavelength

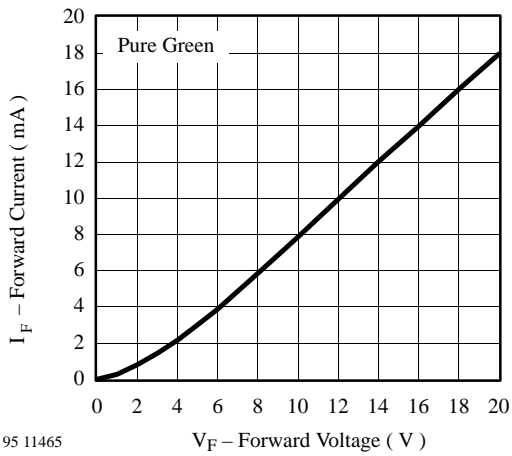

Figure 25. Forward Current vs. Forward Voltage

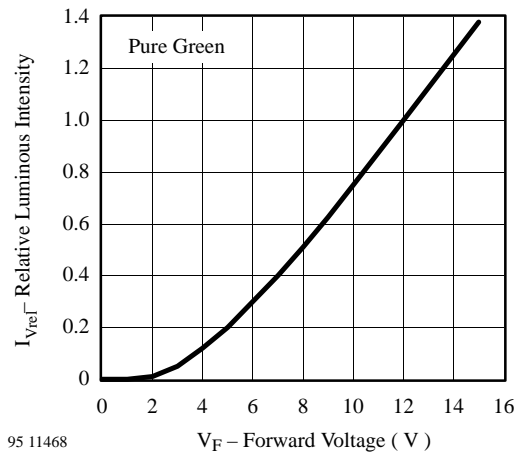

Figure 28. Relative Luminous Intensity vs. Forward Voltage

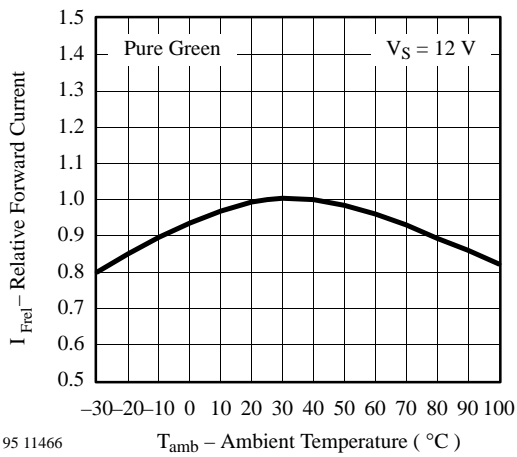

Figure 26. Relative Forward Current vs. Ambient Temperature

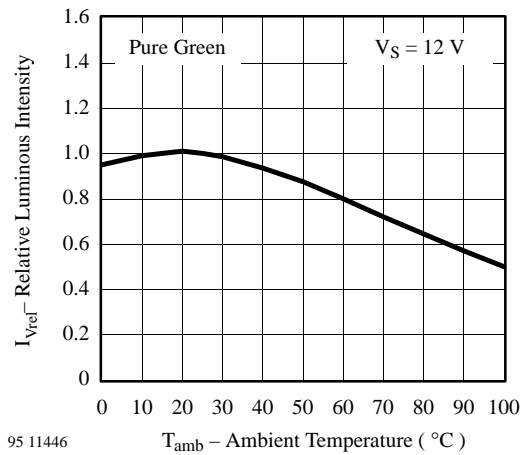

Figure 29. Rel. Luminous Intensity vs. Ambient Temperature

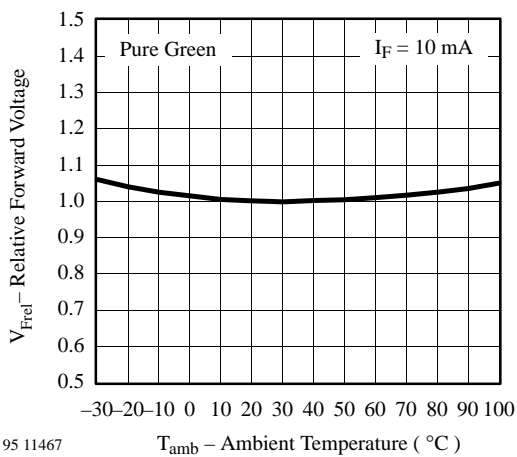
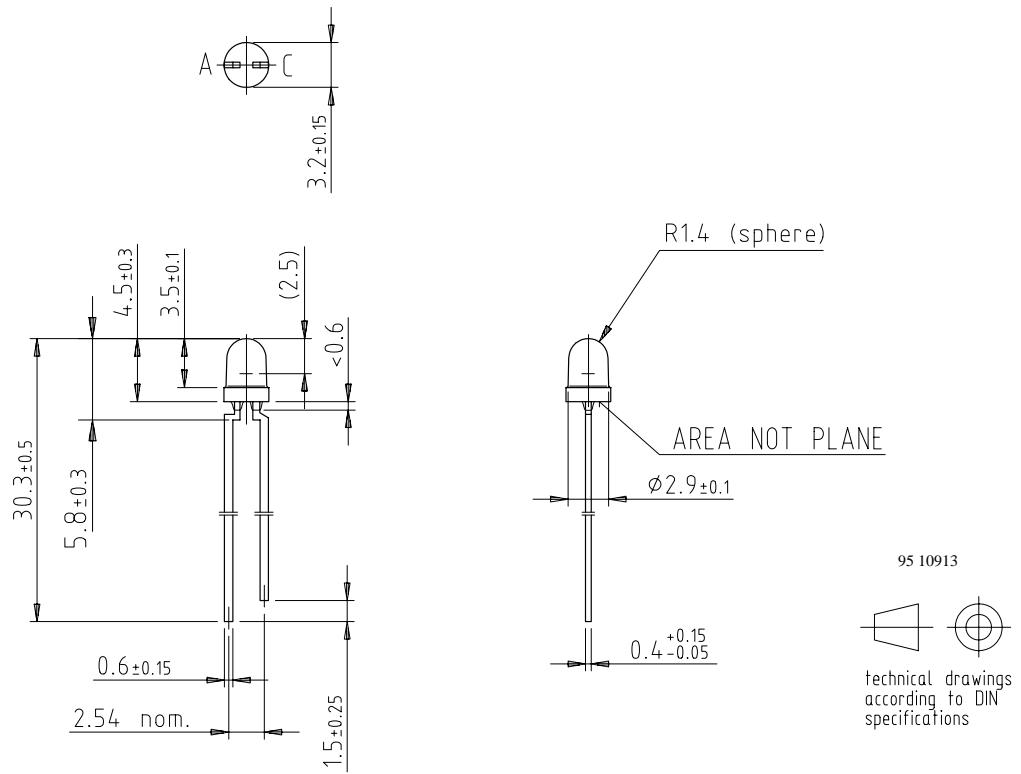

Figure 27. Relative Forward Voltage vs. Ambient Temperature

Dimensions in mm



Ozone Depleting Substances Policy Statement

It is the policy of **Vishay Semiconductor GmbH** to

1. Meet all present and future national and international statutory requirements.
2. Regularly and continuously improve the performance of our products, processes, distribution and operating systems with respect to their impact on the health and safety of our employees and the public, as well as their impact on the environment.

It is particular concern to control or eliminate releases of those substances into the atmosphere which are known as ozone depleting substances (ODSs).

The Montreal Protocol (1987) and its London Amendments (1990) intend to severely restrict the use of ODSs and forbid their use within the next ten years. Various national and international initiatives are pressing for an earlier ban on these substances.

Vishay Semiconductor GmbH has been able to use its policy of continuous improvements to eliminate the use of ODSs listed in the following documents.

1. Annex A, B and list of transitional substances of the Montreal Protocol and the London Amendments respectively
2. Class I and II ozone depleting substances in the Clean Air Act Amendments of 1990 by the Environmental Protection Agency (EPA) in the USA
3. Council Decision 88/540/EEC and 91/690/EEC Annex A, B and C (transitional substances) respectively.

Vishay Semiconductor GmbH can certify that our semiconductors are not manufactured with ozone depleting substances and do not contain such substances.

We reserve the right to make changes to improve technical design and may do so without further notice.

Parameters can vary in different applications. All operating parameters must be validated for each customer application by the customer. Should the buyer use Vishay-Telefunken products for any unintended or unauthorized application, the buyer shall indemnify Vishay-Telefunken against all claims, costs, damages, and expenses, arising out of, directly or indirectly, any claim of personal damage, injury or death associated with such unintended or unauthorized use.

Vishay Semiconductor GmbH, P.O.B. 3535, D-74025 Heilbronn, Germany
Telephone: 49 (0) 7131 67 2831, Fax number: 49 (0) 7131 67 2423