

BOTTOM VIEW OF CONNECTOR

3	B
2	B
1	B

NOTES PLEASE SEE PAGE 3 OF 3

REVISE AS PER EC NO. S2000-0130 DRAWN: REGINA SHAN 010313 CHK: APPR:	DESCRIPTION	QUALITY SYMBOLS	GENERAL TOLERANCES: (UNLESS SPECIFIED)		SCALE	DESIGN UNITS	THIRD ANGLE PROJECTION	DIMENSIONS:		SHT	REV
		MAJOR ▼ = 0	mm	INCH	NTS	<input checked="" type="checkbox"/> mm <input type="checkbox"/> INCH	<input checked="" type="checkbox"/> mm <input type="checkbox"/> INCH	mm ONLY	mm	mm	mm
		CRITICAL ▽ = 0	ANGULAR: ± °		DRAWN BY & DATE REGINA SHAN 000512		TITLE: 1mm BOARD-TO-BOARD SMT RECEPTACLE CONNECTOR ASSEMBLY		MOLEX INCORPORATED		
		REV	APPROVED BY & DATE S. K. TOH 000608		CHECKED BY & DATE LILY CHANG 000608		APPROVED BY & DATE S. K. TOH 000608		MATERIAL NO. SEE TALBE		DRAWING NO. SD-87433-001

THIS DRAWING CONTAINS INFORMATION THAT IS PROPRIETARY TO MOLEX INCORPORATED AND SHOULD NOT BE USED WITHOUT WRITTEN PERMISSION.

SIZE
A3

TAPE AND REEL WIDTHS AND HOLE DIMENSIONS CONFORM TO EIA-481 STANDARDS.

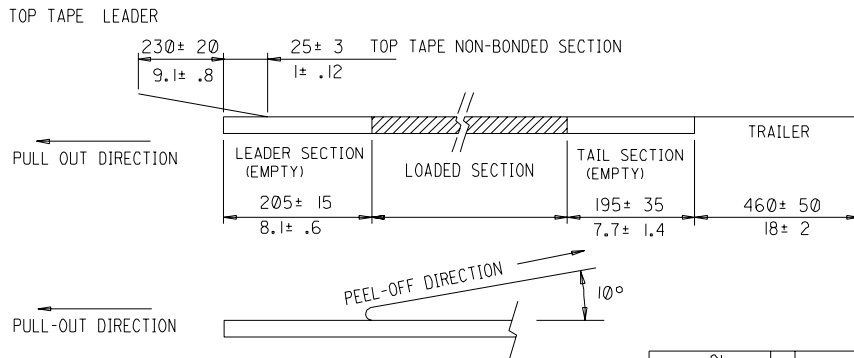
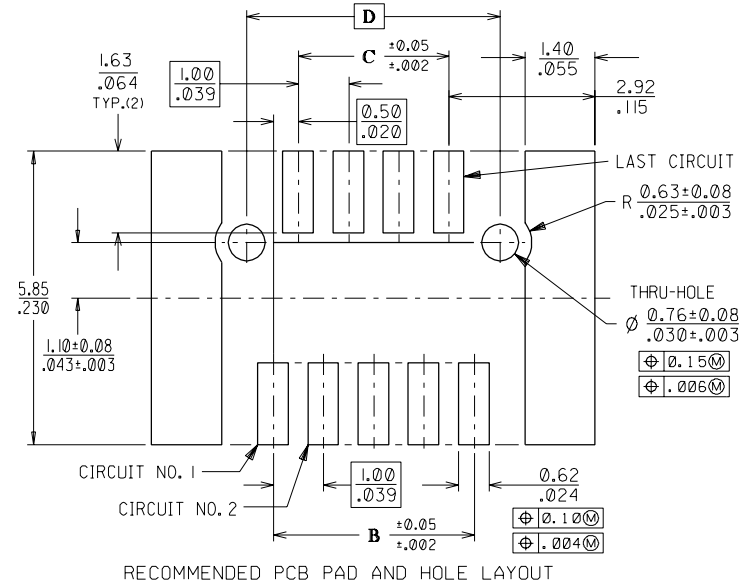
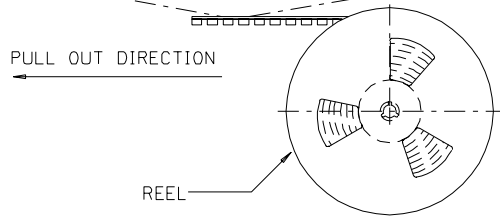
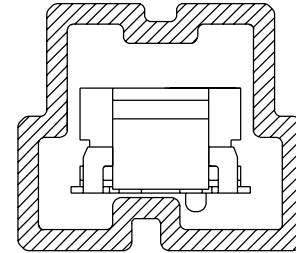
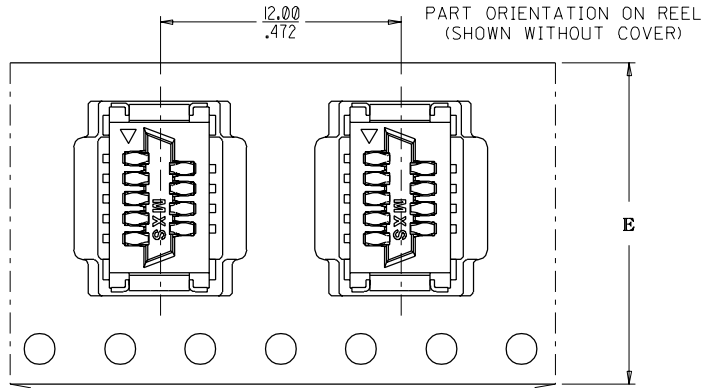

REVISE AS PER EC NO. S2000-0130 DRAWN: REGINA SHAN 010312 CHK: APPR:	DESCRIPTION	QUALITY SYMBOLS	GENERAL TOLERANCES: (UNLESS SPECIFIED)		SCALE NTS	DESIGN UNITS	THIRD ANGLE PROJECTION	DIMENSIONS:	SHT	REV	
		MAJOR ▼ = 0 CRITICAL ▽ = 0	mm	INCH	mm	INCH	mm	mm ONLY	INCH	mm ONLY	REVISE ON CAD ONLY
B	REV	4 PLACES	± 0. —	±. —	DRAWN BY & DATE REGINA SHAN 000512	TITLE: 1mm BOARD-TO-BOARD SMT RECEPTACLE CONNECTOR ASSEMBLY	APPROVED BY & DATE S. K. TOH 000608	MATERIAL NO. SEE TABLE	DRAWING NO. SD-87433-001	SHEET NO. 2 OF 3	THIS DRAWING CONTAINS INFORMATION THAT IS PROPRIETARY TO MOLEX INCORPORATED AND SHOULD NOT BE USED WITHOUT WRITTEN PERMISSION.
		3 PLACES	± 0. —	±. 008							
		2 PLACES	± 0. 20	±. —							
		1 PLACE	± 0. —	±. —							
ANGULAR: ± °					MATERIAL NO. NA		DRAWING NO. SD-87433-001		SHEET NO. 2 OF 3		
MOLEX INCORPORATED											
SIZE A3											

DWG. NO. 87433-56*0
 SD-
 CAD FILE S87433AB.DGN

DO NOT SCALE DRAWING

TAPE AND REEL WIDTHS AND HOLE DIMENSIONS CONFORM TO EIA-481 STANDARDS.

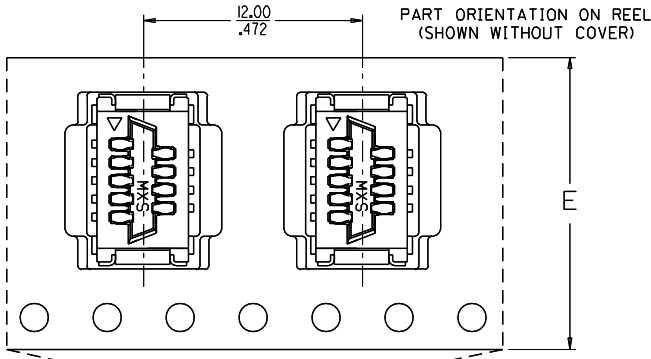

PART NO.	CKT. SIZE	PART QTY. PER REEL	DIMENSIONS				
			A	B	C	D	E
87433-56*0	11	1000	$\frac{10.30}{.406}$	$\frac{5.00}{.197}$	$\frac{4.00}{.157}$	$\frac{6.05}{.238}$	$\frac{24.00}{.945}$
87433-58*0	15	1000	$\frac{12.30}{.484}$	$\frac{7.00}{.276}$	$\frac{6.00}{.236}$	$\frac{8.05}{.317}$	$\frac{24.00}{.945}$

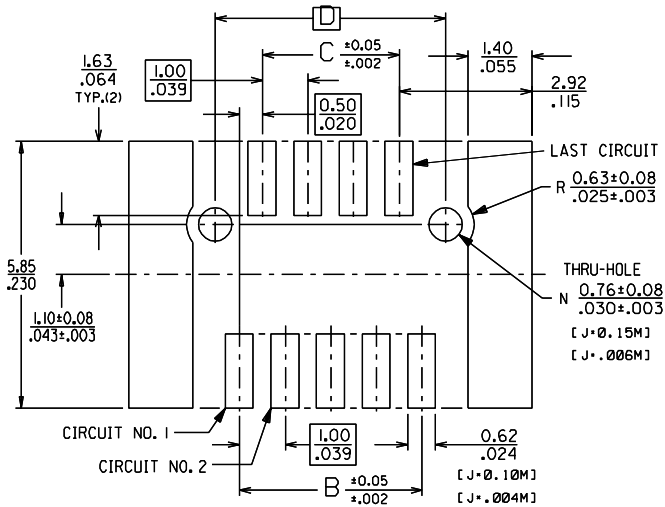
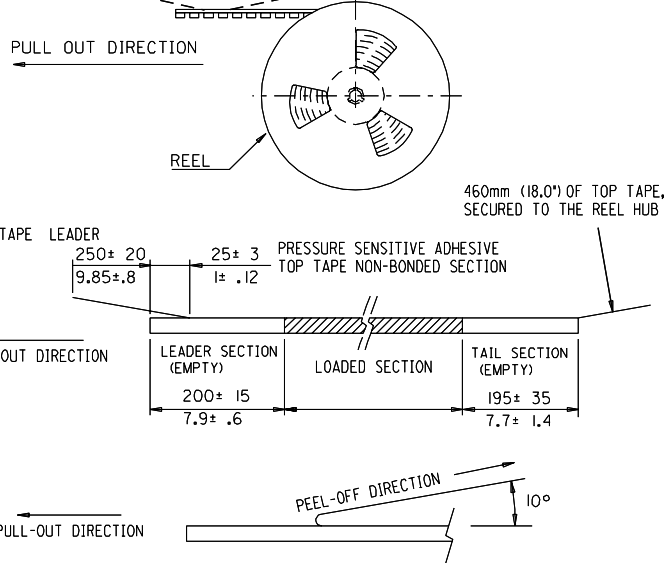

RECOMMENDED PCB PAD AND HOLE LAYOUT

MM
INCH

				MATERIAL : SEE SHEET 1		MOLEX SINGAPORE PTE LTD SHEET 2 OF 2	
				FINISH :		GENERAL TOLERANCES ± 0.20/.008	
SEE SHEET 1				DRAWN BY		DWG. NO. : SD- 87433-56*0	
REVISION RECORD				APPR'D BY		TITLE : Imm BOARD-TO-BOARD SMT RECEPTACLE CONNECTOR ASSEMBLY	
REVISION RECORD				SCALE			