

## Features

- 60V/5A,  
 $R_{DS(ON)} = 58m\Omega$  (Type) @  $V_{GS} = 10V$   
 $R_{DS(ON)} = 70m\Omega$  (Type) @  $V_{GS} = 4.5V$
- ESD Protected
- Reliable and Rugged
- Ultra Low On-Resistance
- 100% avalanche tested
- Lead Free and Green Available

## Applications

- Power Management
- DC-DC Converter
- Motor Control

## Pin Description

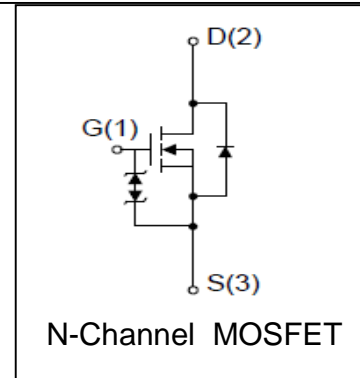
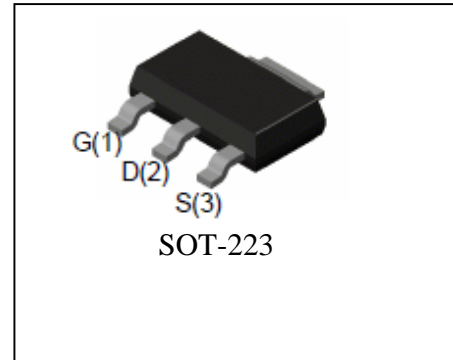

## Absolute Maximum Ratings

Symbol	Parameter	Rating	Unit
<b>Common Ratings</b> ( $T_A = 25^\circ C$ Unless Otherwise Noted)			
$V_{DSS}$	Drain-Source Voltage	60	V
$V_{GSS}$	Gate-Source Voltage	$\pm 20$	
$T_J$	Maximum Junction Temperature	150	$^\circ C$
$T_{STG}$	Storage Temperature Range	-55 to 150	$^\circ C$
$I_S$	Diode Continuous Forward Current	$T_C = 25^\circ C$ 5	A
<b>Mounted on Large Heat Sink</b>			
$I_{DP}$	300 $\mu s$ Pulse Drain Current Tested	$T_C = 25^\circ C$ 20	A
$I_D$	Continuous Drain Current	$T_C = 25^\circ C$ 5 <sup>①</sup>	A
		$T_C = 70^\circ C$ 4	
$P_D$	Maximum Power Dissipation	$T_C = 25^\circ C$ 2.5	W
		$T_C = 70^\circ C$ 1.6	
$R_{\theta JA}$ <sup>②</sup>	Thermal Resistance-Junction to Ambient	50	$^\circ C/W$

**Electrical Characteristics** ( $T_A=25^\circ\text{C}$  Unless Otherwise Noted)

Symbol	Parameter	Test Condition	RU60E5D			Unit
			Min.	Typ.	Max.	
<b>Static Characteristics</b>						
$BV_{DSS}$	Drain-Source Breakdown Voltage	$V_{GS}=0V, I_{DS}=-250\mu A$	60			V
$I_{DSS}$	Zero Gate Voltage Drain Current	$V_{DS}=60V, V_{GS}=0V$ $T_J=85^\circ\text{C}$			1	$\mu A$
$V_{GS(th)}$	Gate Threshold Voltage	$V_{DS}=V_{GS}, I_{DS}=-250\mu A$	1.5	2	2.7	V
$I_{GSS}$	Gate Leakage Current	$V_{GS}=\pm 16V, V_{DS}=0V$			$\pm 10$	$\mu A$
$R_{DS(ON)}^{(3)}$	Drain-Source On-state Resistance	$V_{GS}=10V, I_{DS}=5A$		58	70	$m\Omega$
		$V_{GS}=4.5V, I_{DS}=3.5A$		70	80	$m\Omega$
<b>Diode Characteristics</b>						
$V_{SD}^{(3)}$	Diode Forward Voltage	$I_{SD}=2.5A, V_{GS}=0V$			1.2	V
$t_{rr}$	Reverse Recovery Time	$I_{SD}=2.5A, dI_{SD}/dt=100A/\mu s$		42		ns
$Q_{rr}$	Reverse Recovery Charge			77		nC
<b>Dynamic Characteristics</b> <sup>(4)</sup>						
$R_G$	Gate Resistance	$V_{GS}=0V, V_{DS}=0V, F=1\text{MHz}$		0.7		$\Omega$
$C_{iss}$	Input Capacitance	$V_{GS}=0V,$ $V_{DS}=30V,$ Frequency=1.0MHz		460		pF
$C_{oss}$	Output Capacitance			44		
$C_{riss}$	Reverse Transfer Capacitance			24		
$t_{d(ON)}$	Turn-on Delay Time	$V_{DD}=30V, R_L=30\Omega,$ $I_{DS}=2.5A, V_{GEN}=10V,$ $R_G=25\Omega$		3		ns
$t_r$	Turn-on Rise Time			4		
$t_{d(OFF)}$	Turn-off Delay Time			12		
$t_f$	Turn-off Fall Time			5		
<b>Gate Charge Characteristics</b> <sup>(4)</sup>						
$Q_g$	Total Gate Charge	$V_{DS}=48V, V_{GS}=10V,$ $I_{DS}=2.5A$		16	20	nC
$Q_{gs}$	Gate-Source Charge			3		
$Q_{gd}$	Gate-Drain Charge			5		

- Notes: ① Current limited by maximum junction temperature.  
 ② When mounted on 1 inch square copper board,  $t \leq 10\text{sec}$ .  
 ③ Pulse test ; Pulse width  $\leq 300\mu s$ , duty cycle  $\leq 2\%$ .  
 ④ Guaranteed by design, not subject to production testing.

**Typical Characteristics**

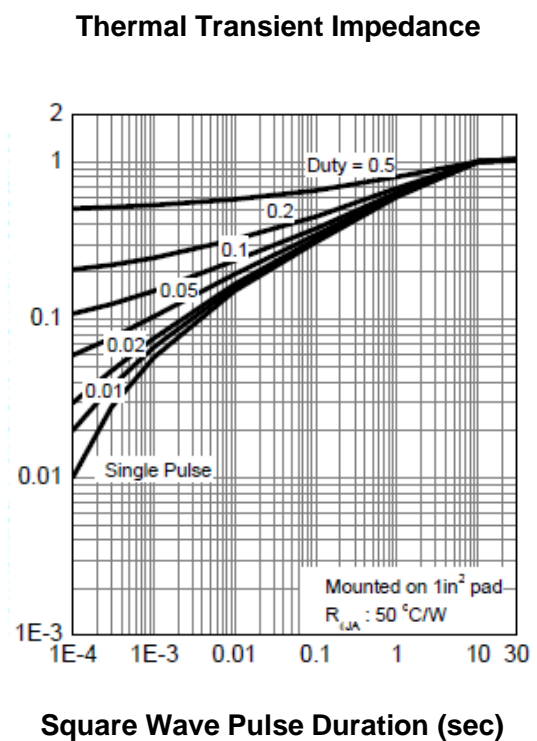
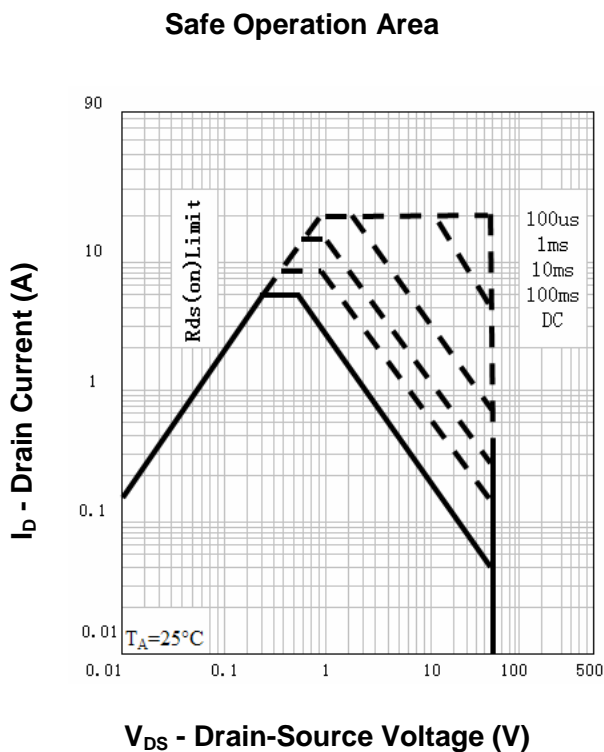
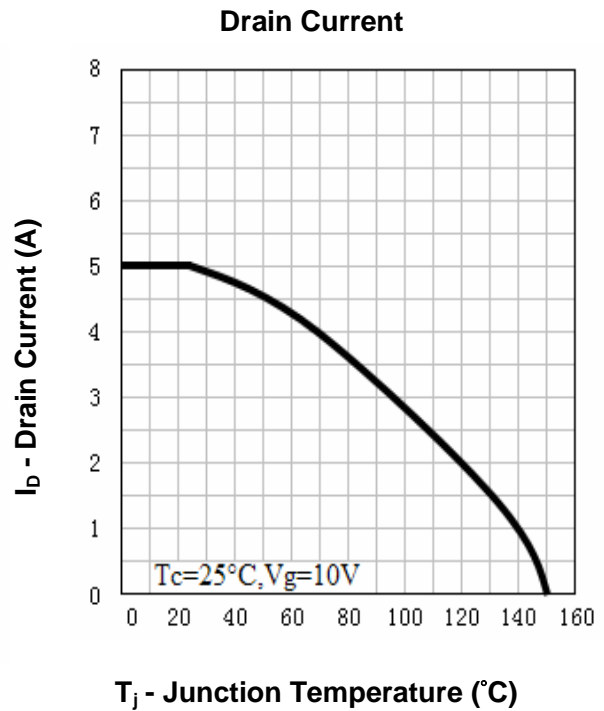
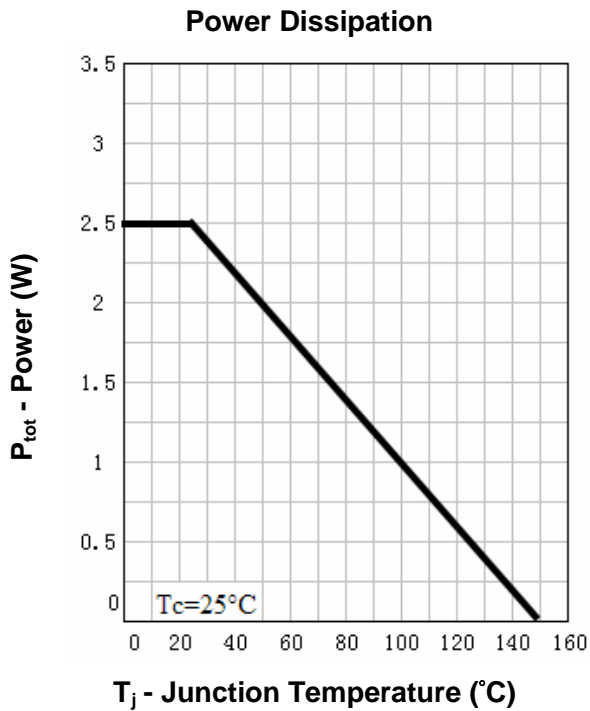

**Typical Characteristics**

**Output Characteristics**

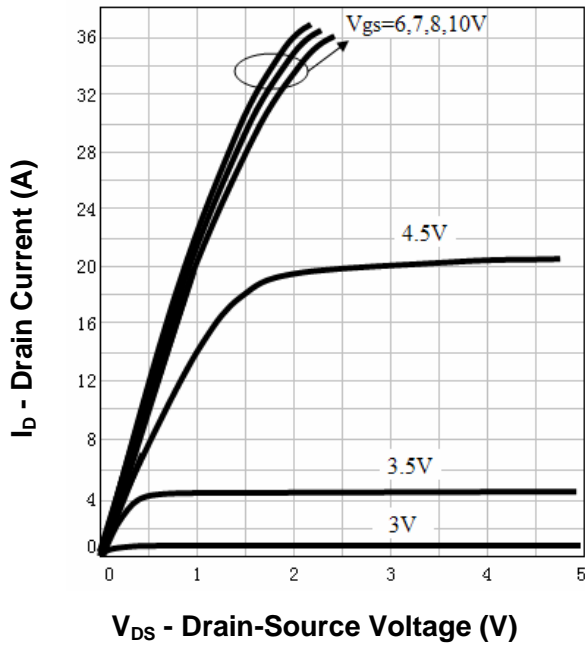

**Drain-Source On Resistance**

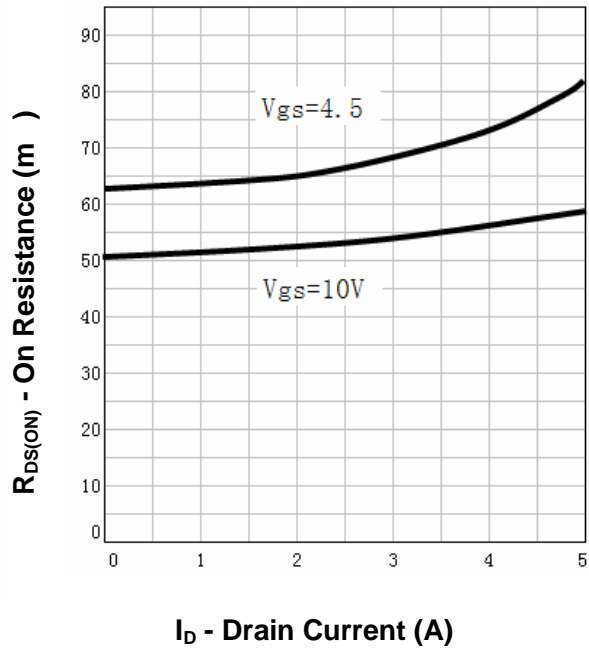

**Drain-Source On Resistance**

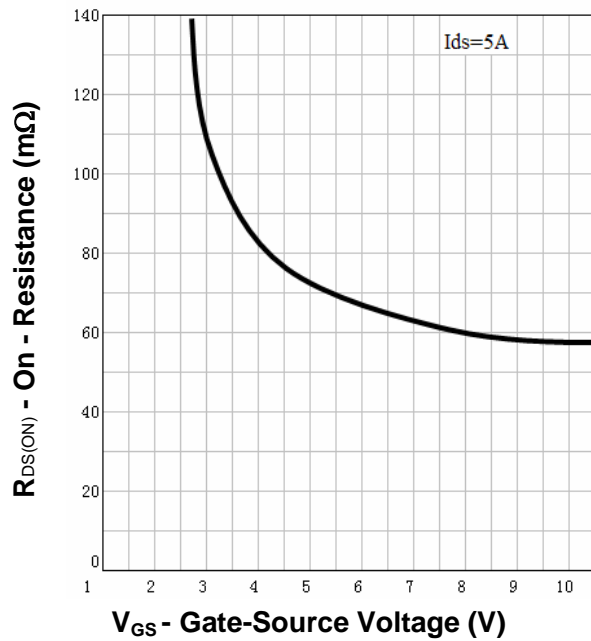

**Gate Threshold Voltage**

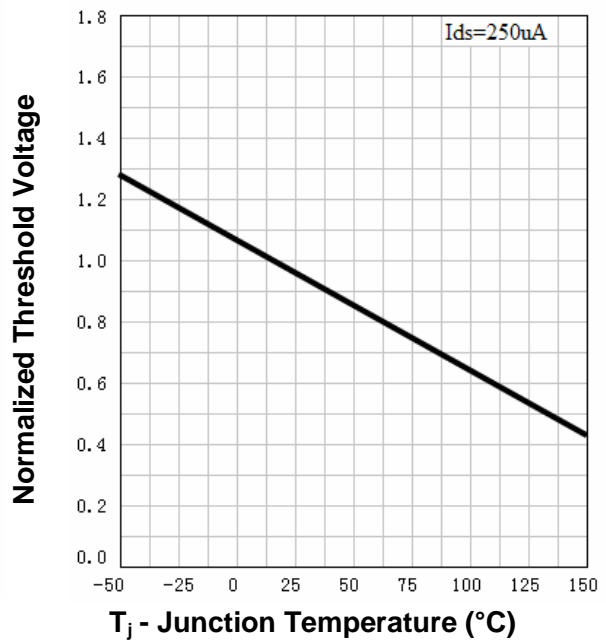

**Typical Characteristics**

**Drain-Source On Resistance**

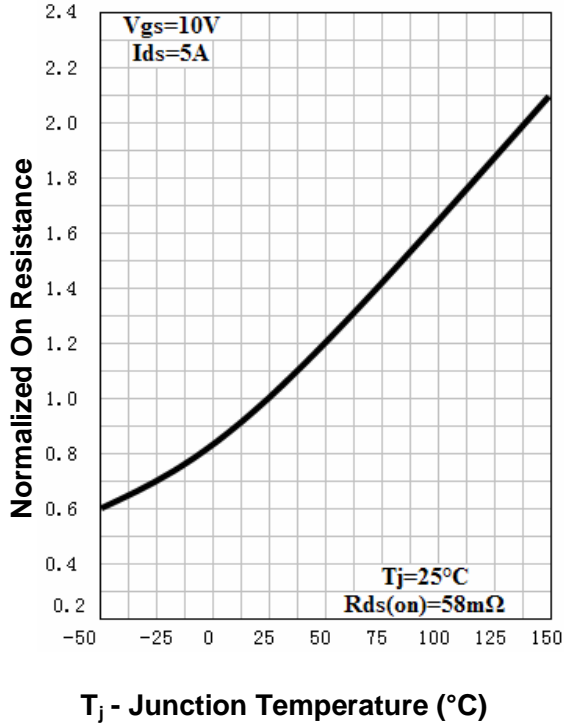

**Source-Drain Diode Forward**

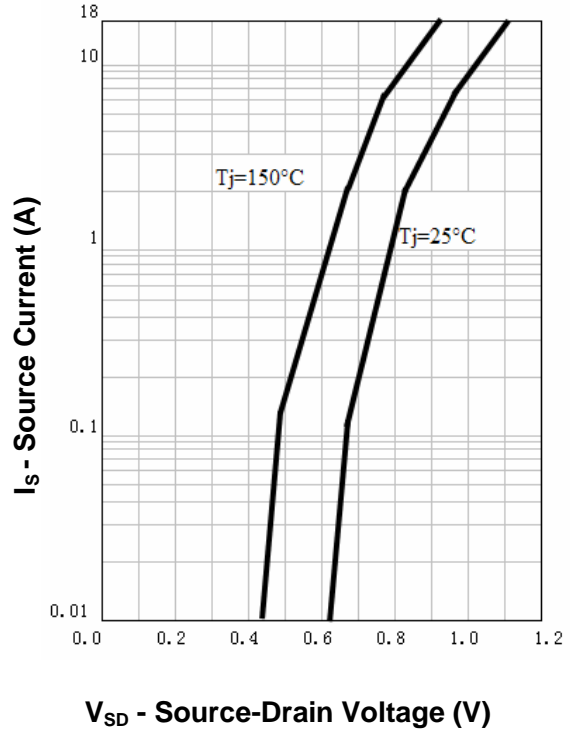

**Capacitance**

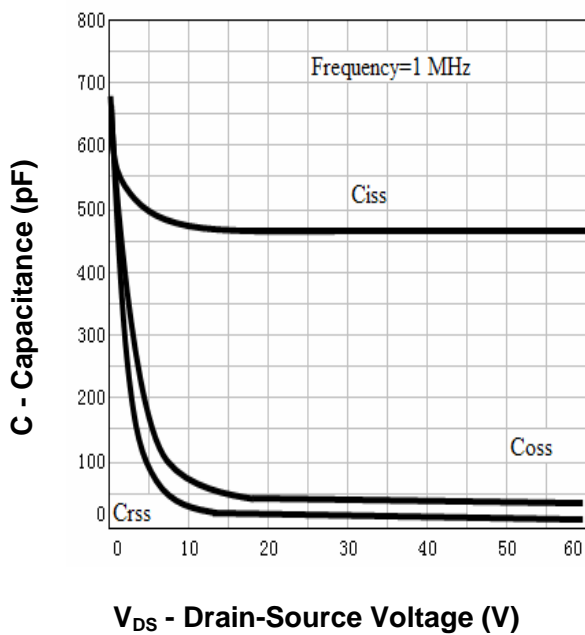

**Gate Charge**

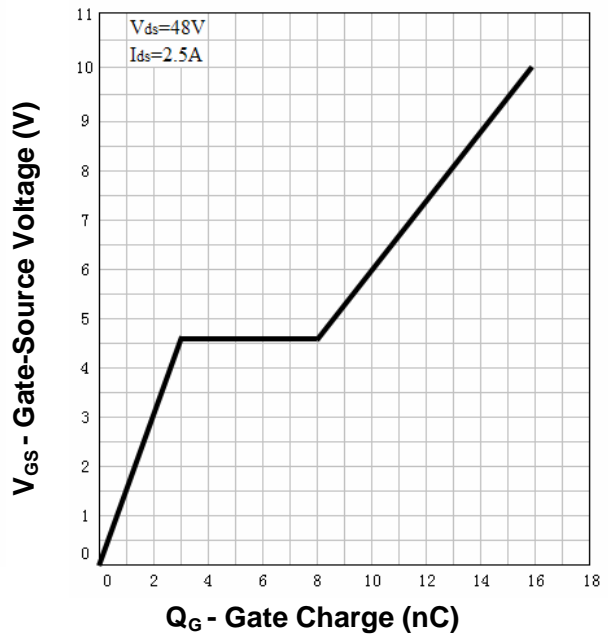

**Ordering and Marking Information****RU60E5****Package (Available)**

D : SOT-223; H: SOP-8 ;

**Operating Temperature Range**

C : -55 to 150 °C

**Assembly Material**

G : Green & Lead Free

**Packaging**

T : TUBE

TR : Tape & Reel

**Package Information**

**SOT-223**

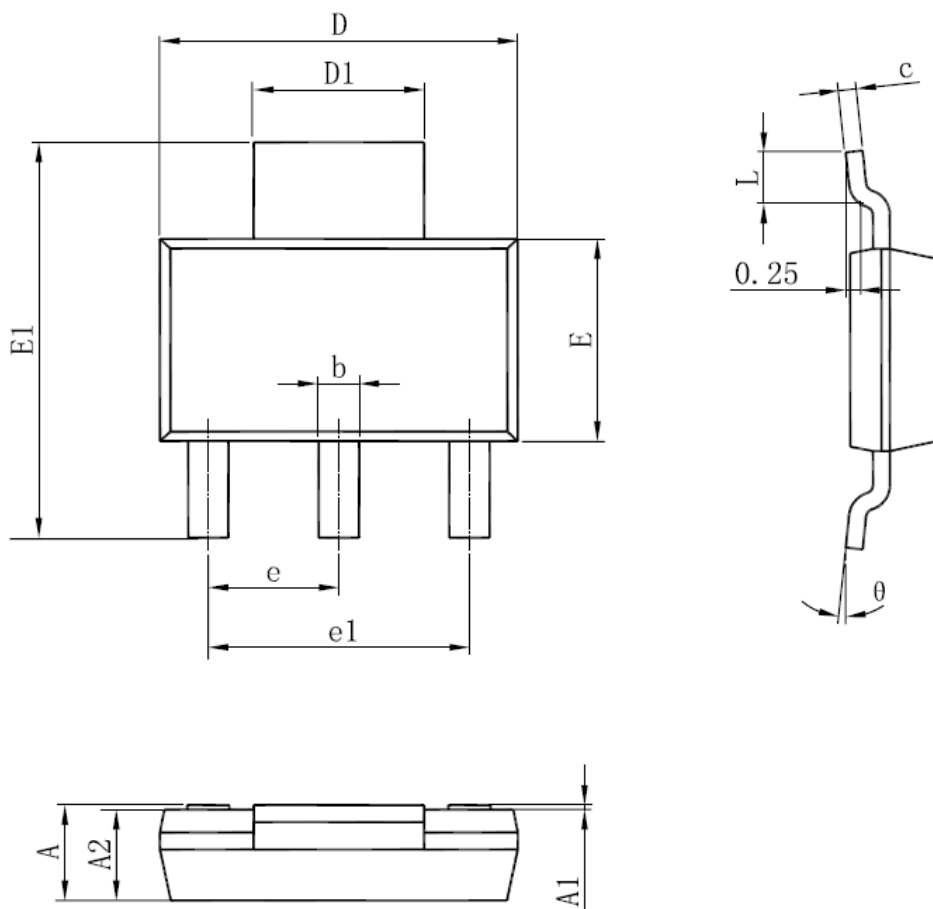

SYMBOL	MM		INCH		SYMBOL	MM		INCH	
	MIN	MAX	MIN	MAX		MIN	MAX	MIN	MAX
A	1.520	1.800	0.060	0.071	E	3.300	3.700	0.130	0.146
A1	0.000	0.100	0.000	0.004	E1	6.830	7.070	0.269	0.278
A2	1.500	1.700	0.059	0.067	e	2.300(BSC)		0.091(BSC)	
b	0.660	0.820	0.026	0.032	e1	4.500	4.700	0.177	0.185
c	0.250	0.350	0.010	0.014	L	0.900	1.150	0.035	0.045
D	6.200	6.400	0.244	0.252	θ	0°	10°	0°	10°
D1	2.900	3.100	0.114	0.122					

ALL DIMENSIONS REFER TO JEDEC STANDARD  
DO NOT INCLUDE MOLD FLASH OR PROTRUSIONS

## **Customer Service**

**Worldwide Sales and Service:**

Sales@ruichips.com

**Technical Support:**

Technical@ruichips.com

**Investor Relations Contacts:**

Investor@ruichips.com

**Marcom Contact:**

Marcom@ruichips.com

**Editorial Contact:**

Editorial@ruichips.com

**HR Contact:**

HR@ruichips.com

**Legal Contact:**

Legal@ruichips.com

**Shen Zhen RUICHIPS Semiconductor CO., LTD**

Room 501, the 5floor An Tong Industrial Building,  
NO.207 Mei Hua Road Fu Tian Area Shen Zhen City, CHINA

**TEL:** (86-755) 8311-5334

**FAX:** (86-755) 8311-4278

**E-mail:** Sales-SZ@ruichips.com