

Low Power FM IF Amplifier

Description

CXA1002M/N is an FM IF amplifier most suitable for cellular and FM radios.

Features

- Includes all the functions needed for cellular radios such as FM detecting circuit, RSSI, IF amplifier and others.
- Wide operating voltage range 4.5 to 9.5 V and low current consumption.
(During $V_{cc}=5\text{ V}$, $I_{cc}=2.5\text{ mA Typ.}$)
- Built-in audio output buffer circuit reduces external parts to a minimum.
- Wide range RSSI and excellent temperature characteristics.
- Compact 16 pin SOP and 16 pin VSOP package.

Functions

- IF amplifier and limiter
- RSSI (Received Signal Strength Indicator)
- FM detecting circuit

Structure

Bipolar silicon monolithic IC

Absolute Maximum Ratings ($T_a=25^\circ\text{C}$)

- | | | | |
|-------------------------------|-----------|-------------|------------------|
| • Supply voltage | V_{cc} | 17 | V |
| • Operating temperature | T_{stg} | -35 to +85 | $^\circ\text{C}$ |
| • Storage temperature | T_{opr} | -55 to +150 | $^\circ\text{C}$ |
| • Allowable power dissipation | P_D | 500 | mW |

Recommended Operating Condition

- | | | | |
|------------------|----------|------------|---|
| • Supply voltage | V_{cc} | 4.5 to 9.5 | V |
|------------------|----------|------------|---|

Package Outline

Unit: mm

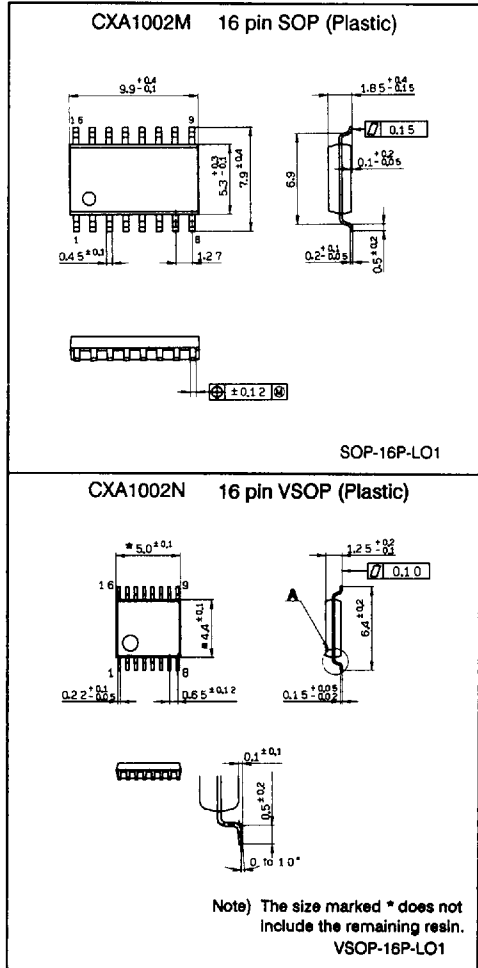

Block Diagram and Pin Configuration (Top View)

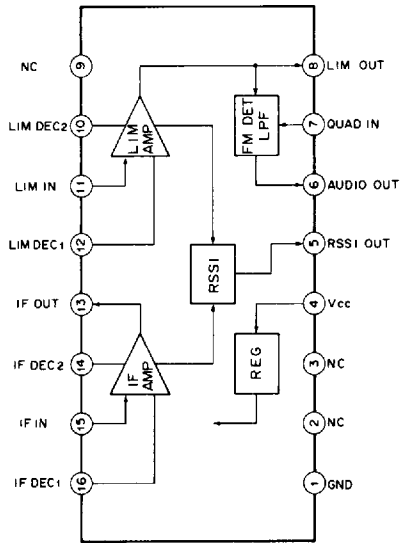

Pin Description and Equivalent circuit

| No. | Symbol | Voltage (Typ) | Equivalent Circuit | Description |
|-----|-----------|---------------|--------------------|--|
| 1 | GND | 0 V | | Ground pin |
| 4 | Vcc | 5.0 V | | Supply pin |
| 5 | RSSI OUT | | | The current output corresponds to the input signal level to IF and LIM amplifiers. |
| 6 | AUDIO OUT | 2.5 V | | FM detected signal is output. |
| 7 | QUAD IN | 3.3 V | | Input pin of quadrature detecting circuit. |

| No. | Symbol | Voltage (Typ) | Equivalent Circuit | Description |
|----------------|--------------------------------|-------------------------|--------------------|---|
| 8 | LIM OUT | 1.7 V | | Output pin of limiter. |
| 10 11 12 | LIM DEC2 LIM IN LIM DEC1 | 1.7 V 1.7 V 1.7 V | | Input and decoupling pin of limiter. Connect pins 10 and 12 to GND by means of a capacitor (0.01 to 0.047 µF). |
| 13 | IF OUT | 1.6 V | | Output pin of IF amplifier. |
| 14 15 16 | IF DEC2 IF IN IF DEC1 | 1.6 V 1.6 V 1.6 V | | Input and decoupling pin of IF amplifier. Connect pins 14 and 16 to GND by means of a capacitor (0.01 to 0.047 µF). |

3

Electrical Characteristics

See the Electrical Characteristics Test Circuit
 Ta=25°C, Vcc=5 V, 0 dBm=223.6 mVrms

| No. | Item | Symbol | SW turned ON | Input signal No. | Remarks | Test Point | Min. | Typ. | Max. | Unit |
|-----|-------------------------|--------|--------------|---------------------------------------|---|----------------|------|------|------|-------|
| 1 | Consumption current | Icc | | | | I ₁ | 2.0 | 2.5 | 3.0 | mA |
| 2 | IF amp voltage gain | VG1 | | V _{IN1} : 455kHz -50 dBm | | V ₁ | 34 | 36 | 38 | dB |
| 3 | Limiter voltage gain | VG2 | | V _{IN2} : 455kHz -90 dBm | | V ₂ | 70 | 72 | 74 | dB |
| 4 | Limiter output voltage | VO2 | | V _{IN2} : 455kHz -20 dBm | | V ₂ | 500 | 570 | 640 | mVp-p |
| 5 | Audio output voltage | VO3 | S3 | V _{IN2} : 455kHz -20 dBm | f _{AUDIO} = 1 kHz DEV = ±8 kHz FM | V ₃ | 115 | 195 | 245 | mVrms |
| 6 | Audio output distortion | VD3 | | V _{IN2} : 455kHz -20 dBm | f _{AUDIO} = 1 kHz DEV = ±8 kHz FM | V ₃ | | | 1 | % |
| 7 | Audio output S/N | SN3 | | V _{IN2} : 455kHz -20 dBm | | V ₃ | 40 | | | dB |
| 8 | Audio output AMRR | AR3 | | V _{IN2} : 455kHz -20 dBm | f _{AUDIO} = 1 kHz MOD = ±80% AM | V ₃ | 30 | | | dB |
| 9 | RSSI output voltage L | VO4L | S1, S2 | V _{IN1} : 455kHz -100 dBm | | V ₄ | 0.25 | 0.40 | 0.55 | V |
| 10 | RSSI output voltage H | VO4H | S1, S2 | V _{IN1} : 455kHz -20 dBm | | V ₄ | 1.50 | 1.85 | 2.20 | V |

Electrical Characteristics Test Circuit

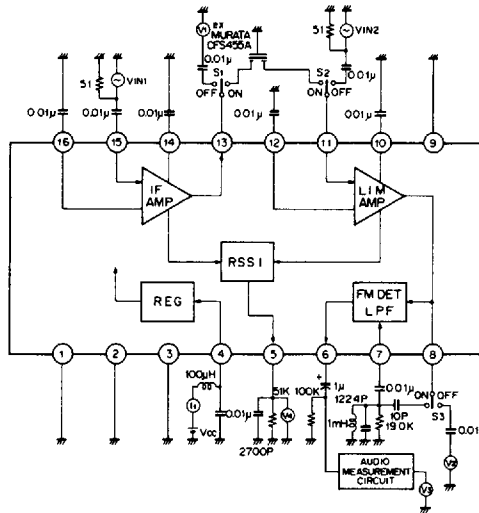

Operation

Signals passing through the filter and input through pin 15, amplified at IF amplifier and output through pin 13. IF amplifier output is subjected again to band limitation, to amplitude limitation at the limiter amplifier and output through pin 8. The limiter amplifier output is phase shifted at the LC resonance circuit and after undergoing quadrature detection, audio signals are output from pin 6. For RSSI, at IF and limiter amplifiers stages, a current corresponding to the input levels is obtained, added up and output from pin 5. RSSI voltage output is obtained by connecting a suitable I to V conversion circuit (resistor and capacitor parallel circuit) to pin 5.

Application Circuit

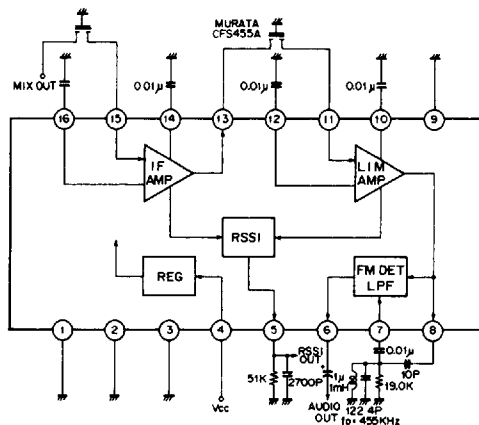

Notes on Usage

Voltage gain of IF amplifier in CXA1002M/N is about 36 dB. Voltage gain of the limiter amplifier is rather high at 72 dB. Please take the following precautions:

1. Decouple pin 4 (Vcc) with L and C as near to the pins as possible.
2. Be sure to ground pins 2, 3 and 9 (NC).
3. Separate input line from the output line as far as possible, and make the wiring short.
4. Decoupling capacitors of IF amplifier (pins 14, 16) and limiter amplifier (pins 10, 12) should be grounded as close to the respective pins as possible.
5. Work out the GND pattern to obtain an impedance as low as possible.
6. Electrostatic separation of the limiter amplifier input and output parts by setting up and shield plate gives better efficiency. (Mark use of pin 1 GND and pin 9 NC)

Application Note

1) Supply

With the built-in voltage regulator, CXA1002M/N has wide operating power supply voltage range from +4.5 to 9.5 V (Typ. 5.0 V). Within the above supply voltage range, there are almost no changes in the characteristics.

Decouple pin 4 (Vcc) with L and C. (See Fig. below)

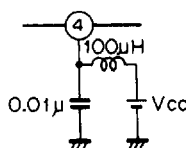

Decoupling

2) Filter

The most suitable band pass filter to be connected between pins 13 and 11 of CXA1002M/N should have the following specifications.

- I/O impedance : 1.5 k Ω \pm 10%
- Insertion loss (center frequency): <6 dB

3) Phase shifter

To execute quadrature FM detection, the limiter output (pin 8) phase is shifted 90° by means of the RLC parallel resonance circuit or the discriminator and input through pin 7.

The Fig. below show the phase shifter made up by the RLC parallel resonance circuit. In this case set L, C value so that the 2nd IF signal frequency and the parallel resonance frequency become similar. As R value sets the audio output level, select this value so as to obtain the required output.

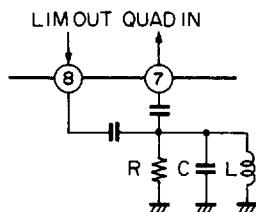

RLC Phase Shifter

4) Audio output
 FM modulated audio and data signals are demodulated at the previous stage and output from pin 6 (Audio out).

5) RSSI
 RSSI is function that detects the magnitude of the input signal level. In CXA1002M/N, it is output with current, and increases almost uniformly within the range of IF input level -100 to 0 dBm (2.24μ to 224 mVrms). It is almost free from the supply voltage and temperature influence. However the output current is distributed within a range of $\pm 20\%$ by means of the resistance inside the IC.
 When voltage output is required, it performs I to V conversion by means of a resistance. The value of that resistance is determined by RSSI's maximum output current and the maximum allowable voltage of pin 5. With RSSI's maximum output current at about 60μ A (Typ. 45μ A) and the allowable maximum voltage (performance guaranteed maximum voltage) at $V_{CC} - 1.8$ V, select the resistance according to the supply voltage and the required output voltage.
 When an output voltage of $V_{CC} - 1.8$ V and above is required use the function after amplifying by means of an operational amplifier.
 When the RSSI output voltage is required at AMPS which is the cellular radio standard. A uniform increase from 0 V is defined. However, for CXA1002M/N as there is an offset of about 0.3 to 0.5 V ($V_{CC}=5$ V, $R_L=51$ k Ω), arrange to start from 0 V by using an offset compensation circuit.

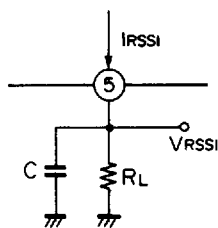

RSSI I to V circuit

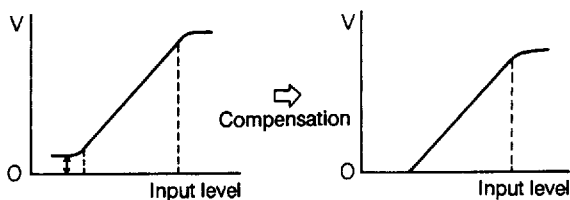

RSSI output voltage offset compensation

IF amplifier voltage gain frequency characteristics

Ta = 25°C
Vcc = 5V
RF level = -50dBm

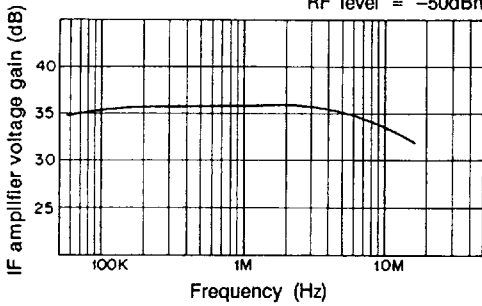

Limiter amplifier voltage gain frequency characteristics

Ta = 25°C
Vcc = 5V
RF level = -90dBm

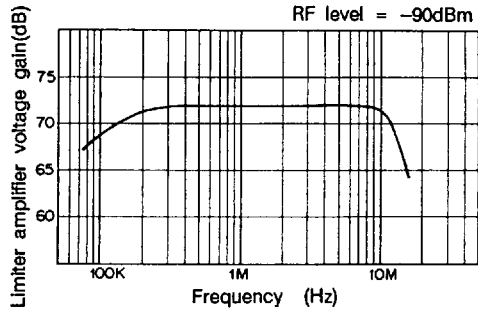

Audio demodulation characteristics (IF IN/AUDIO OUT)

*Used Audio Test Circuit

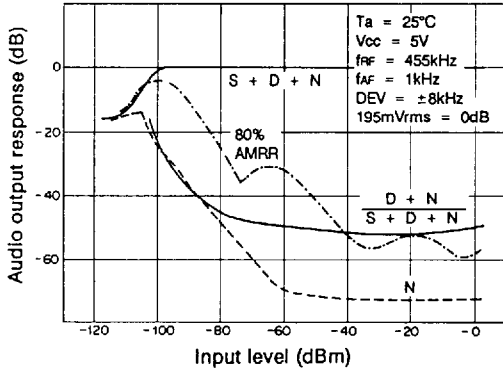

Audio I/O characteristics

Ta = 25°C
Vcc = 5V
RF level = -20dBm
fRF = 455kHz
fAF = 1kHz
DEV = ±2.9kHz

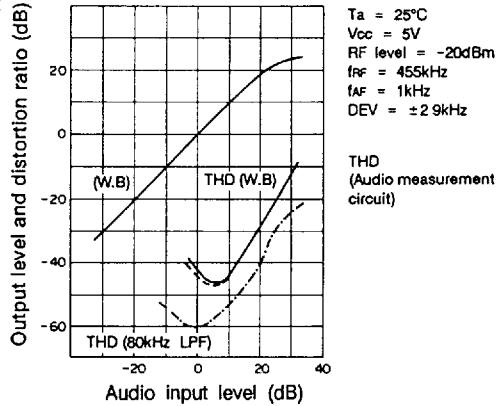

RSSI characteristics

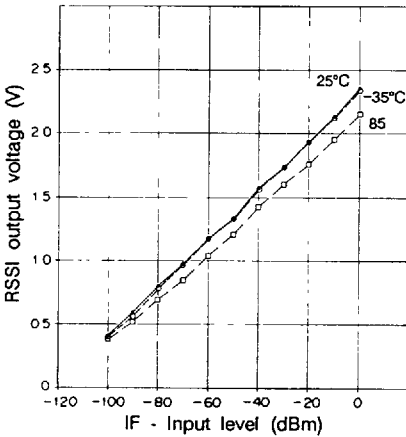

RX-audio filter frequency characteristics (A-B AMPS Standard)

(BPF + DEEMP)

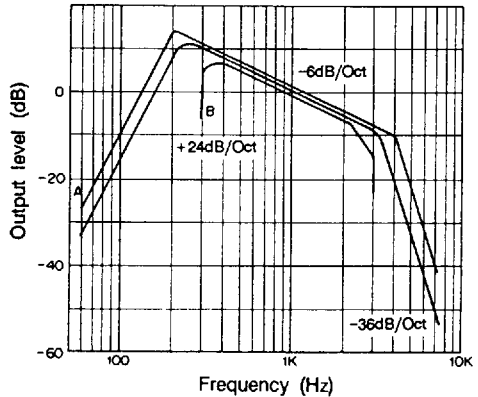



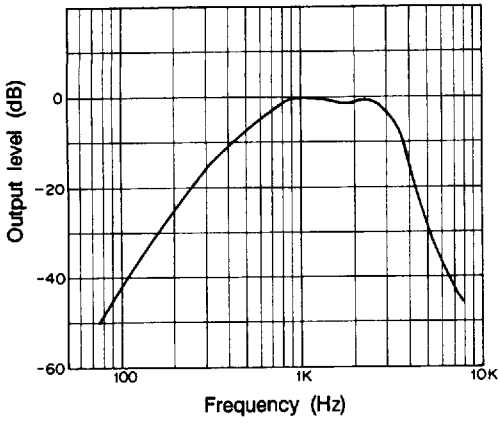



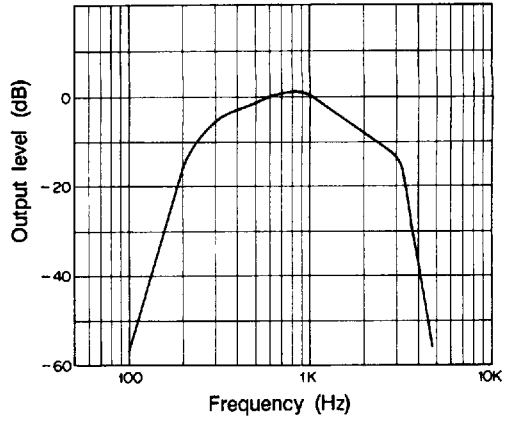







C-message filter frequency characteristics



Audio test circuit frequency characteristics



Package Name

| Type | Package name | | Package | Features | | | | | |
|-----------------------|-----------------|-----------------------------------|--------------------------------|---|--|------------------------------------|--------------------------|--------------------|-------------|
| | Symbol | Description | | Material | Lead pitch | Lead shape | Lead pull out direction | | |
| Inserted | Standard | D I P | DUAL IN-LINE PACKAGE |  | P C | 2.54mm (100MIL) | Through Hole Lead | 2-direction | |
| | | S I P | SINGLE IN LINE PACKAGE |  | P | 2.54mm (100MIL) | Through Hole Lead | 1-direction | |
| | | Z I P | ZIG ZAG IN-LINE PACKAGE |  | P | 2.54mm (100MIL) Zig-Zag in-line | Through Hole Lead | 1-direction | |
| | | P G A | PIN GRID ARRAY |  | C | 2.54mm (100MIL) | Through Hole Lead | Package under side | |
| | | PIGGY BACK | PIGGY BACK |  | C | 2.54mm (100MIL) | Through Hole Lead | 2-direction | |
| | Shrink | SDIP | SHRINK DUAL IN-LINE PACKAGE |  | P | 1.778mm (70MIL) | Through Hole Lead | 2-direction | |
| | | SZIP | SHRINK ZIG-ZAG IN-LINE PACKAGE |  | P | 1.778mm (70MIL) Zig-Zag in-line | Through Hole Lead | 1-direction | |
| | Surface mounted | Standard flat package | Q F P | QUAD FLAT L LEADED PACKAGE |  | P C | 1.0mm 0.8mm 0.65mm | Gull-Wing | 4-direction |
| | | | S O P | SMALL OUTLINE L-LEADED PACKAGE |  | P | 1.27mm (50MIL) | Gull-Wing | 2-direction |
| | | Standard 2-direction chip carrier | S O J | SMALL OUTLINE J-LEADED PACKAGE |  | P | 1.27mm (50MIL) | J-Lead | 2-direction |
| Shrink flat package | | VQFP | VERY SMALL QUAD FLAT PACKAGE |  | P | 0.5mm | Gull-Wing | 4-direction | |
| | | VSOP | VERY SMALL OUTLINE PACKAGE |  | P | 0.65mm | Gull-Wing | 2-direction | |
| | | TSOP | THIN SMALL OUTLINE PACKAGE |  | P | 0.5mm (0.55mm) | Gull-Wing | 2-direction | |
| Standard chip carrier | | Q F J | QUAD FLAT J-LEADED PACKAGE |  | P | 1.27mm (50MIL) | J-Lead | 4-direction | |
| | | Q F N | QUAD FLAT NON-LEADED PACKAGE |  | C | 1.27mm (50MIL) | Leadless | Package under side | |

* PPlastic, CCeramic

2