



SANYO Semiconductors

DATA SHEET

An ON Semiconductor Company

LA4809M — Monolithic Linear IC Stereo Headphone Amplifier

Overview

LA4809M is a 2-channels power amplifier to drive the headphone with wide supply voltage range.

To minimize the effects of power supply, the regulator circuit for control of the output power is built-in to enable setting of the output power value adequate for the headphone amplifier (2 types of set value available). This product also has the standby function, and is suitable as a driver for wide-ranging headphone.

Applications

Headphone driver for TV and audio equipment

Features

- 2-channels power amplifier built-in (maximum output power value changeable according to the setting)
 - Maximum output power A = 55mW Standard (Pin 10 : Open)
 - Maximum output power B = 160mW Standard (Pin 10 : GND)
 - * $V_{CC} = 12V$, $R_L = 16\Omega$, THD = 10%
 - *Change to another power value possible by adding the external parts
- Regulator built-in : Limited change of the output power value due to fluctuation of supply voltage
 - High-Ripple rejection ratio
- Standby function (also used for voice muting) : Current drain at standby = $0.01\mu A$ Standard ($V_{CC} = 12V$)
- Overheat protection circuit built-in
- Wide supply voltage range (differing according to the set value of maximum output power) : $V_{CC} = 3.6V$ to $17V$

■ Any and all SANYO Semiconductor Co.,Ltd. products described or contained herein are, with regard to "standard application", intended for the use as general electronics equipment (home appliances, AV equipment, communication device, office equipment, industrial equipment etc.). The products mentioned herein shall not be intended for use for any "special application" (medical equipment whose purpose is to sustain life, aerospace instrument, nuclear control device, burning appliances, transportation machine, traffic signal system, safety equipment etc.) that shall require extremely high level of reliability and can directly threaten human lives in case of failure or malfunction of the product or may cause harm to human bodies, nor shall they grant any guarantee thereof. If you should intend to use our products for applications outside the standard applications of our customer who is considering such use and/or outside the scope of our intended standard applications, please consult with us prior to the intended use. If there is no consultation or inquiry before the intended use, our customer shall be solely responsible for the use.

■ Specifications of any and all SANYO Semiconductor Co.,Ltd. products described or contained herein stipulate the performance, characteristics, and functions of the described products in the independent state, and are not guarantees of the performance, characteristics, and functions of the described products as mounted in the customer's products or equipment. To verify symptoms and states that cannot be evaluated in an independent device, the customer should always evaluate and test devices mounted in the customer's products or equipment.

LA4809M

Specifications

Maximum Ratings at $T_a = 25^\circ\text{C}$

Parameter	Symbol	Conditions	Ratings	Unit
Maximum supply voltage	V_{CC} max	Without signal	18	V
Allowable power dissipation	P_d max	* Mounted on a printed circuit board.	1.75	W
Maximum junction temperature	T_j max		150	$^\circ\text{C}$
Operating temperature	T_{opr}		-30 to +75	$^\circ\text{C}$
Storage temperature	T_{stg}		-40 to +150	$^\circ\text{C}$

* Evaluation board of SANYO Semiconductor : 50mm × 50mm × 0.8mm (Glass epoxy double-side PCB)

Operating Conditions at $T_a = 25^\circ\text{C}$

Parameter	Symbol	Conditions	Ratings	Unit
Recommended supply voltage	V_{CC}		12	V
Recommended load resistance	R_L		16 to 32	Ω
Operating supply voltage range	V_{CC} op-1	mode-B (for P_O max = 160mW)	6.2 to 17	V
	V_{CC} op-2	mode-A (for P_O max = 55mW)	4.2 to 17	V
	V_{CC} op-3	* Depending on the output power value when the external part is added	3.6 to 17	V

* Determine the supply voltage with due consideration of the allowable power dissipation.

* Note that the supply voltage range is limited depending on the setting of the maximum output power value.

Electrical Characteristics at $T_a = 25^\circ\text{C}$, $V_{CC} = 12\text{V}$, $R_L = 16\Omega$, $f_{in} = 1\text{kHz}$, $V_3 = 2\text{V}$, Pin 10 : open

Parameter	Symbol	Conditions	Ratings			Unit
			min	typ	max	
Quiescent current drain	I_{CCOP}	No signal		3.8	6.5	mA
Standby current drain	I_{STBY}	No signal, Standby mode ($V_3 = 0.3\text{V}$)		0.01	5	μA
Maximum output power-A	P_{OMAXA}	THD = 10%, mode-A	30	55		mW
Maximum output power-B	P_{OMAXB}	THD = 10%, mode-B (Pin 10 : gnd)	87	160		mW
Voltage gain	VG	$V_{in} = -20\text{dBV}$	10.2	11.7	13.2	dB
Channel balance	CHB	$V_{in} = -20\text{dBV}$	-1.5	0	+1.5	dB
Total harmonic distortion	THD	$V_{in} = -20\text{dBV}$		0.15	0.7	%
Output noise voltage	V_{NOUT}	$R_g = 620\Omega$, 20 to 20kHz		18	50	μVrms
Channel separation	CHsep	$V_{in} = -15\text{dBV}$	60	72		dB
Mute attenuation level	VMT	$V_{in} = -10\text{dBV}$, Standby mode ($V_3 = 0.3\text{V}$)	-80	-88		dBV
Ripple rejection ratio	SVRR	$R_g = 620\Omega$, $f_r = 100\text{Hz}$, $V_r = -10\text{dBV}$	70	81		dB
Pin 2 voltage-A	V2A	mode-A		2.1		V
Pin 2 voltage-B	V2B	mode-B (Pin 10 : gnd)		3.1		V
STBY control HIGH voltage	VSBH	(Circuit power mode)	2		9	V
STBY control LOW voltage	VSBL	(Circuit standby mode)	0		0.6	V

* mode-A (Pin 10 = open) : P_O max = 55mW

Pin 2 voltage : $V_2 = 2.1\text{V}$, Internal regulator voltage : $V_{reg} = 2 \times V_2 = 4.2\text{V}$, Amp operating reference voltage : $V_{ref} = 1 \times V_2 = 2.1\text{V}$

mode-B (Pin 10 = gnd) : P_O max = 160mW

Pin 2 voltage : $V_2 = 3.1\text{V}$, Internal regulator voltage : $V_{reg} = 2 \times V_2 = 6.2\text{V}$, Amp operating reference voltage : $V_{ref} = 1 \times V_2 = 3.1\text{V}$

LA4809M

Package Dimensions

unit : mm (typ)
3384

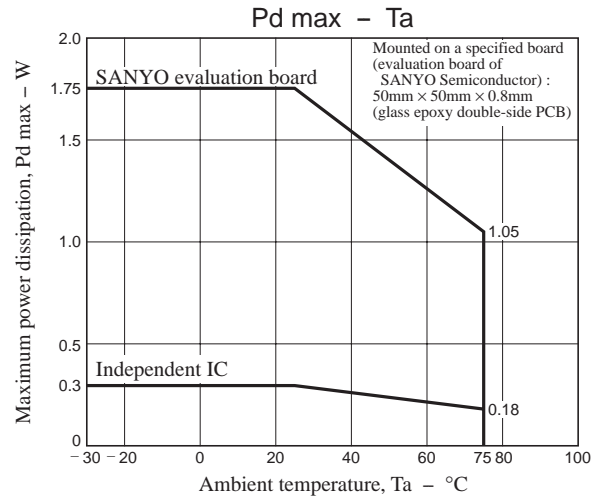
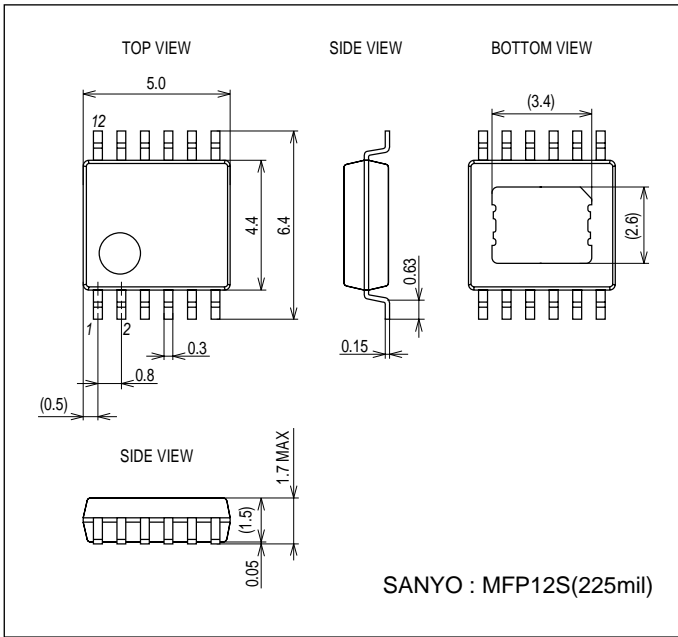

Evaluation board

Copper foil pattern diagram
(Dimensions : 50mm × 50mm × 0.8mm)

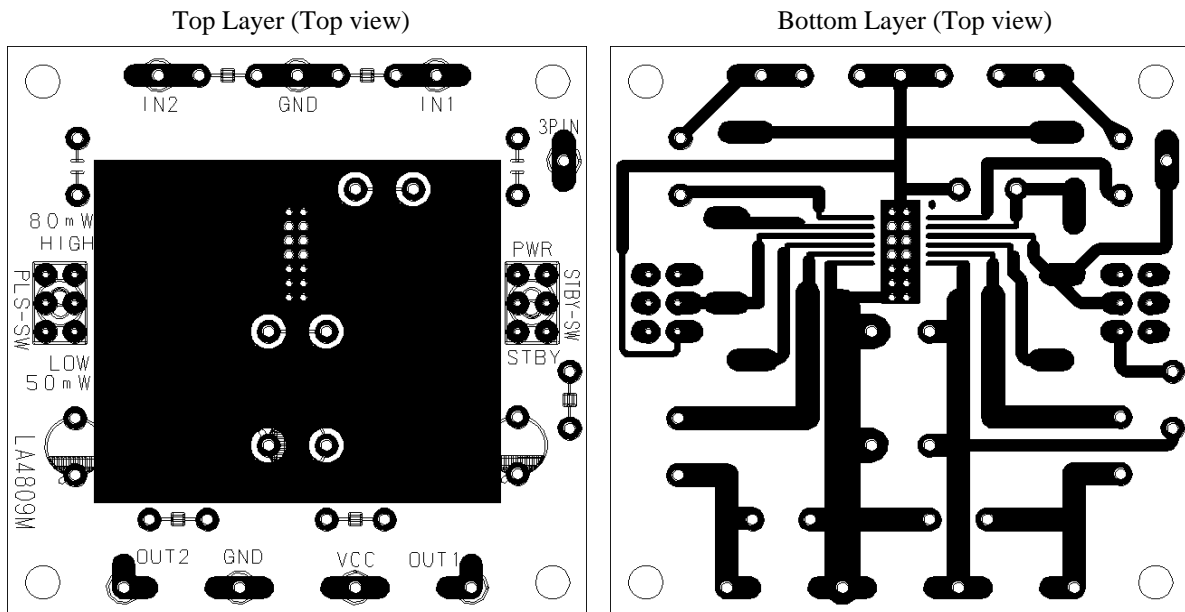

LA4809M

Block Diagram and Sample Application Circuit

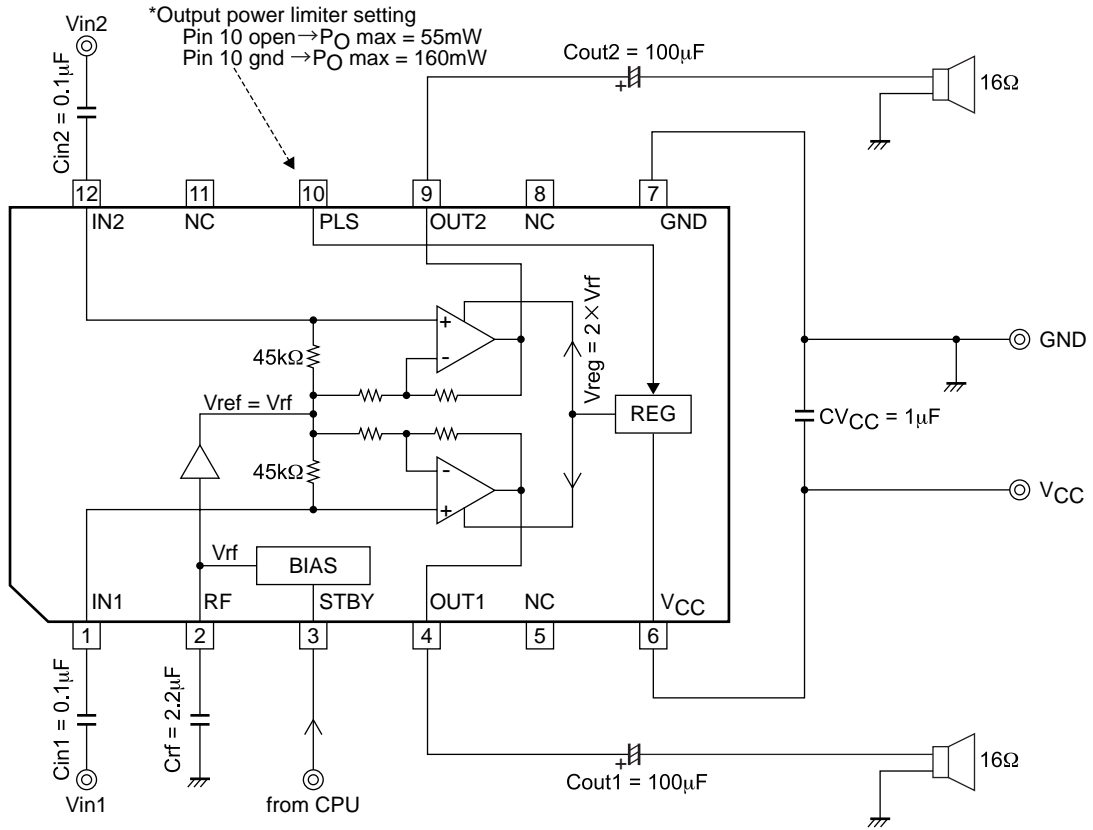

Test Circuit Diagram

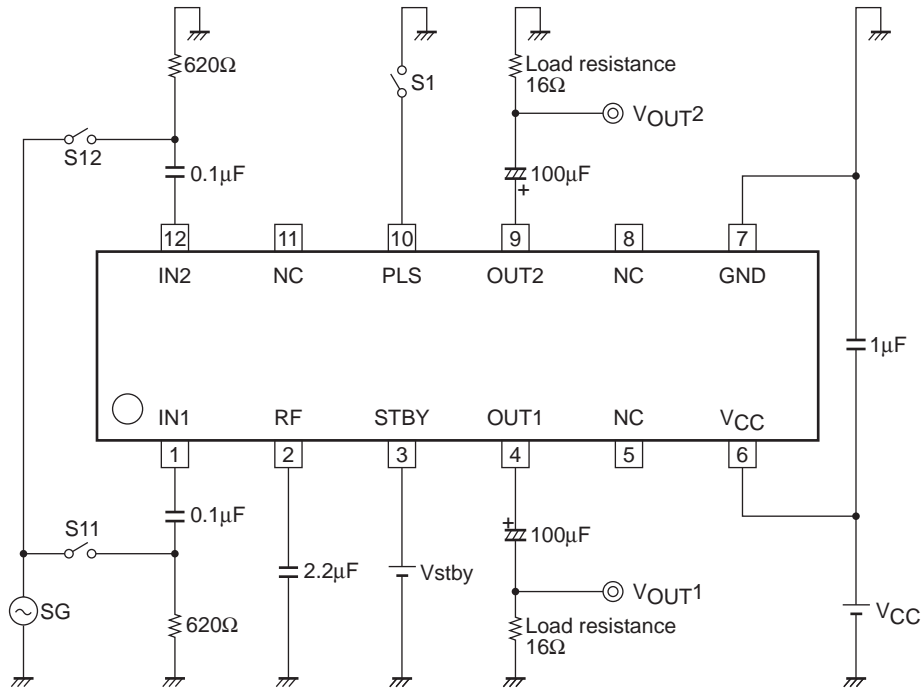

LA4809M

Pin Functions

Pin No.	Pin Name	Pin Voltage (V)		Description	Equivalent Circuit
		mode-A	mode-B		
1 12	IN1 IN2	2.1	3.1	Amplifier input pin.	
2	RF	2.1	3.1	Reference voltage pin.	
3	STBY	Applied	Applied	Standby control pin. (to which the external voltage is applied)	
4 9	OUT1 OUT2	2.1	3.1	Amplifier output pin.	
5 8 11	NC			NC pin.	
6	V _{CC}	Applied	Applied	Power pin. (to which the external voltage is applied)	
7	GND	GND	GND	GND pin.	
10	PLS	0.69	GND	Output power selection pin.	

Cautions for use

1. Input coupling capacitors (Cin1, Cin2)

Cin1 (Cin2) is an input coupling capacitor, which is intended for DC cut. This capacitor forms a high pass filter together with the internal resistance of 45kΩ attenuating the bass frequency signal. Set the capacitance value with due consideration of the cut-off frequency.

Note that the cut-off frequency is expressed as follows :

$$1\text{ch} \Rightarrow fc1 = 1 / (2\pi \times \text{Cin1} \times 45000)$$

$$2\text{ch} \Rightarrow fc2 = 1 / (2\pi \times \text{Cin2} \times 45000)$$

This capacitor also affects the pop noise at a time of falling. Note that setting the higher capacitance value causes delay of the capacitor discharge rate, causing louder pop noise.

2. Output coupling capacitors (Cout1, Cout2)

Cout1 (Cout2) is an output coupling capacitor, which is intended for DC cut. This capacitor forms a high pass filter together with the load impedance of RL, attenuating the bass frequency signal. Set the capacitance value with due consideration of the cut-off frequency. Normally, the chemical capacitor is used. When setting the capacitance value, take into account the characteristics of the chemical capacitor, namely, the capacitance value of chemical capacitor tends to decrease at low temperature.

Note that the cut-off frequency is expressed as follows :

$$1\text{ch} \Rightarrow fc3 = 1 / (2\pi \times \text{Cout1} \times \text{RL})$$

$$2\text{ch} \Rightarrow fc4 = 1 / (2\pi \times \text{Cout2} \times \text{RL})$$

This capacitor also affects the pop noise at a time of rising. Note that setting the higher capacitance value causes louder pop noise.

3. Power supply line capacitor (CVCC)

CVCC is intended to stabilize the power supply line. Arrange this capacitor as near to IC as possible and always use the ceramic capacitor with superior high frequency characteristics.

Increase the capacitance value when the power supply line is relatively unstable.

4. Pin 2 capacitor (Crf)

Crf is a capacitor to determine the transient response characteristics of the Pin 2 voltage (reference voltage) : Vrf. At a time of rising, this is charged by the internal constant-current source (about 39μA). At a time of falling, this is discharged by the internal resistance (about 157kΩ). Due attention must be paid because pop noise and the amplifier rise / fall time change depending on the transient response characteristics of Pin 2 voltage. Decreasing the capacitance value to shorten the response time, pop noise becomes louder. Therefore, the use of the value shown below as the capacitance value is recommended. As this capacitor reduces the power supply ripple component, decrease in the capacitance value results in lowering of the ripple removal ratio.

Crf recommended values : 1μF to 3.3μF

5. Voltage gain

The voltage gain of amplifier is determined by the internal resistance and is fixed at about 11.7dB. When the output level is to be changed, attempt attenuation with the resistor in the forward stage of input as shown in Fig.1. To enhance the degree of attenuation, use two resistors as shown in Fig.2 so as to reduce internal-resistor variation factors. Though attenuation in the backward stage of output as shown in Fig.3 is possible, this may cause decrease in the maximum output power.

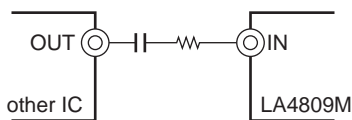

(Low attenuation degree)
Fig.1

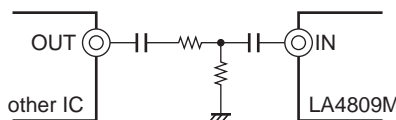

(High attenuation degree)
Fig.2

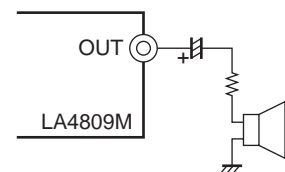

Fig.3

6. Load capacitance

When connecting a capacitor between the output pin and GND for an anti-electric wave radiation measure, this capacitor may cause decrease in the phase margin of power amplifier, resulting in the oscillation phenomenon. When connecting this capacitor, pay attention to its capacitance value.

Recommended capacitance value : 560pF or less, or 0.01μF to 0.1μF

7. Selection of the maximum output power value (handling of Pin 10)

This IC enables selection of two types of maximum output power value according to the handling method of Pin 10. The regulator circuit for output power control is built in, in which, by changing the voltage of Pin 2, the regulator voltage : V_{reg} is changed to enable selection of the maximum output power value.

Mode-A ($P_O \text{ max} = 55\text{mW}$) : Pin 10 set to the OPEN state

Pin 2 voltage : $V_2 = 2.1\text{V}$,

Internal regulator voltage : $V_{reg} = 4.2\text{V}$,

Amplifier operating reference voltage : $V_{ref} = 2.1\text{V}$

Mode-B ($P_O \text{ max} = 160\text{mW}$) : Pin 10 connected to the GND line

Pin 2 voltage : $V_2 = 3.1\text{V}$,

Internal regulator voltage : $V_{reg} = 6.2\text{V}$,

Amplifier operation reference voltage : $V_{ref} = 3.1\text{V}$

When the maximum output power value is to be changed under CPU control, use the NPN transistor as shown in Fig.4, so that the Pin 10 voltage approaches the GND potential (0.1V or below) sufficiently.

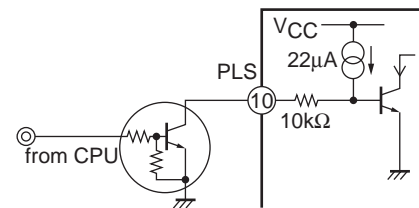

Fig.4

8. Change of the maximum output power value (by handling Pin 2)

Pin 2 voltage : V_2 is determined from the constant-current source and internal resistance as shown in Fig.5.

Operating \Rightarrow Mode-A : $54\text{k}\Omega$ used

Mode-B : $80\text{k}\Omega$ ($54\text{k}\Omega + 26\text{k}\Omega$) used

Not operating (at a time of falling) $\Rightarrow 157\text{k}\Omega$ ($54\text{k}\Omega + 26\text{k}\Omega + 77\text{k}\Omega$) used

The internal regulator voltage and amplifier operating reference voltage are generated from this Pin 2 voltage.

Regulator voltage : $V_{reg} = V_2 \times 2$

Amplifier operating reference voltage : $V_{ref} = V_2 \times 1$

Accordingly, to change the maximum output power value, connect the resistance : R_{rf} between Pin 2 and GND as shown in Fig.5. This will cause change in the Pin 2 voltage. Note that, in view of circuit operation, the Pin 2 voltage must be set to 1.6V or above.

If the discharge constant is not to be changed, Use the NPN transistor to control the R_{rf} connection as shown in Fig.6.

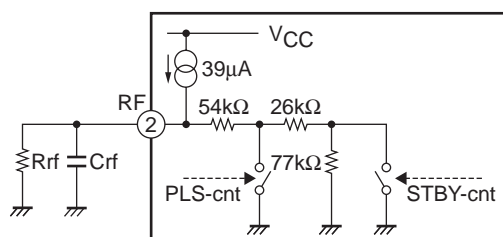

Fig.5

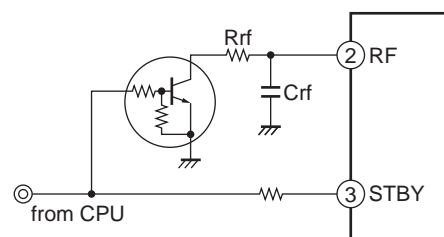

Fig.6

9. Standby pin (Pin 3)

By controlling the standby pin, the mode can be changed over between standby and operation. Though this control is possible directly by the CPU output port, the control may be exposed to adverse affect of digital noise from CPU. It is recommended therefore to insert series resistance ($1\text{k}\Omega$ or more).

Standby mode $\Rightarrow V_3 = 0\text{V}$ to 0.6V

Operation mode $\Rightarrow V_3 = 2\text{V}$ to 9V (for $V_{CC} = 9\text{V}$ or above), $V_3 = 2\text{V}$ to V_{CC} (for $V_{CC} = \text{less than } 9\text{V}$)

Continued on next page.

Continued from preceding page.

When the standby function is not to be used, Pin 3 may be interlocked with power supply as shown in Fig.7. However, due care must be taken in this case because such interlock makes the effectiveness of the pop noise reduction circuit null, resulting in extremely large pop noise at a time of rising and falling. There are also methods to reduce the pop noise by using two capacitors as shown in Fig.8. If pop noise is to be suppressed sufficiently, CPU control of the standby pin is recommended.

Note that the approximate inrush current; I_3 into the standby pin is calculated as follows :

$$\text{Pin 3 inrush current (unit : A) : } I_3 = (5 \times V_{CC} - 4) \times 10^{-5} / R_{st}$$

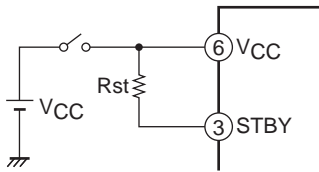

Fig.7

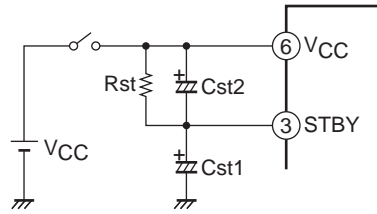

Fig.8

10. Operating power supply voltage range

The applicable power supply voltage range varies depending on the setting conditions of the maximum output power value. Use this range while taking into account the Pin 2 voltage. As a guideline, the supply voltage at the lowest point to be used must be two times the Pin 2 voltage.

Note that the minimum operating supply voltage must be 3.6V.

$$\text{mode-B} \Rightarrow V_{CC \text{ op}} = 6.2\text{V to } 17\text{V}$$

$$\text{mode-A} \Rightarrow V_{CC \text{ op}} = 4.2\text{V to } 17\text{V}$$

$$\text{At change of the output power value due to external resistance} \Rightarrow V_{CC \text{ op}} = 2 \times V_2 \text{ to } 17\text{V} \quad (V_2 \Rightarrow \text{Pin 2 voltage})$$

11. Handling of NC pins (Pins 5, 8, and 11)

NC pins are not connected to anything internally and may be left in the OPEN state. To enhance the heat sink effect as much as possible, connection of NC pins to the GND line is recommended.

In particular, Pin 5 should be connected to the GND line so as to protect Pin 4 (the first output).

If the pins 4 and 5 section and the pins 5 and 6 section are bridged with solder simultaneously, the output pin enters the powering (short to power) state, allowing the large current to flow into the output pin, resulting in deterioration or damage of internal elements. Risk of deterioration or damage may be reduced when Pin 5 is connected to GND. When the output pin voltage is about 0.7V or less, drive and power stages of the power amplifier circuit used becomes inoperable. In this context, the protection in case of ground fault is provided.

12. Heat protective circuit

The heat protective circuit is incorporated in IC and can reduce the risk of damage/deterioration in case of abnormal heat generation due to certain reasons. This protective circuit is activated when the junction temperature: T_j of the chip in IC increases to about 160°C, shutting OFF current supply to the power amplifier. The signal is not output anymore. When the chip temperature lowers (to about 130°C), the circuit is automatically reset.

Note that this circuit is not always capable of preventing damage/deterioration and should be handled with utmost care. In case of abnormal heating, turn OFF power supply immediately and identify the probable causes.

13. Short-circuit between pins

Power ON while leaving the pins in the short-circuit state may cause deterioration or damage. When installing IC to the substrate, check if pins are short-circuited with solder before turning power supply ON.

14. Load short-circuit

Leaving the loads in the short-circuit state over a long period of time may cause deterioration or damage. Never short-circuit loads.

15. Maximum rating

When the product is used near the maximum rating, even the smallest change in the conditions may cause exceeding of the maximum rating, possibly leading to the fracture accident. Take the sufficient fluctuation margin for the supply voltage and always use the product within a range never exceeding the maximum rating. The package used for this IC has the low heat sink effect as a single unit. When the working supply voltage is high, solder the backside heat sink pad to ensure sufficient heat sink performance with copper foil of printed circuit board.

LA4809M

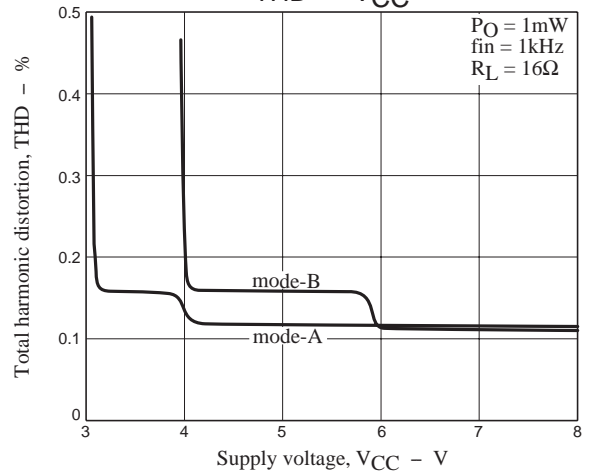
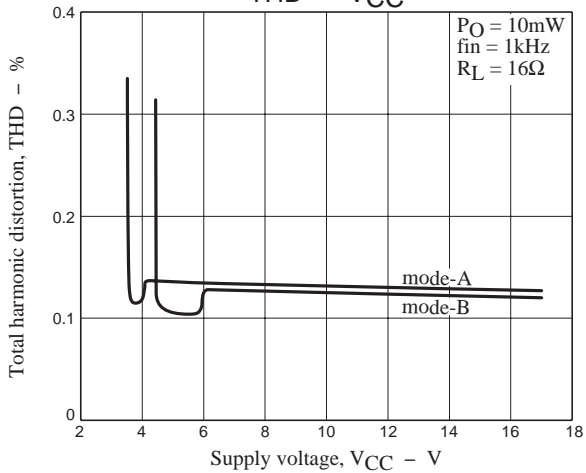
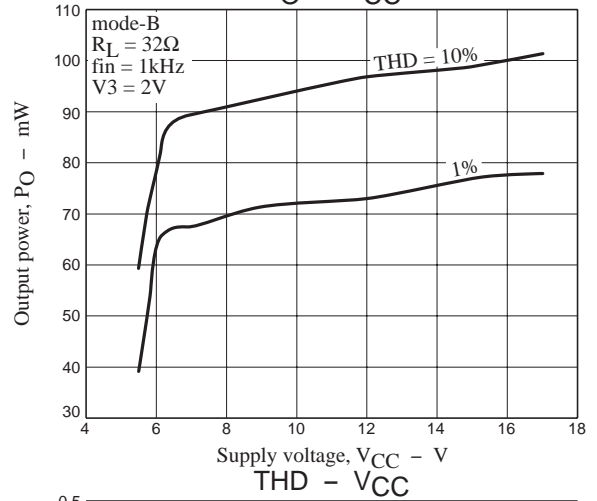
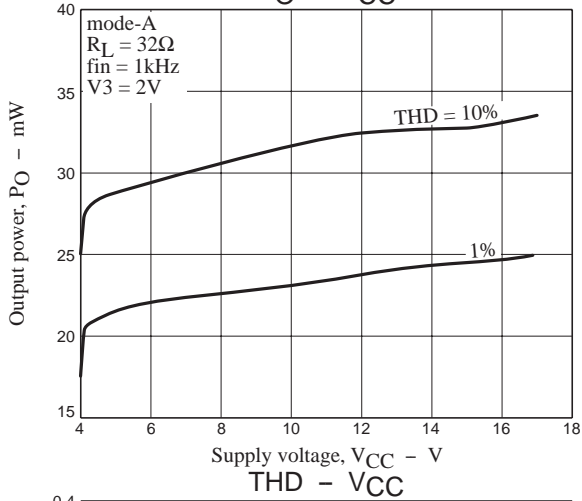
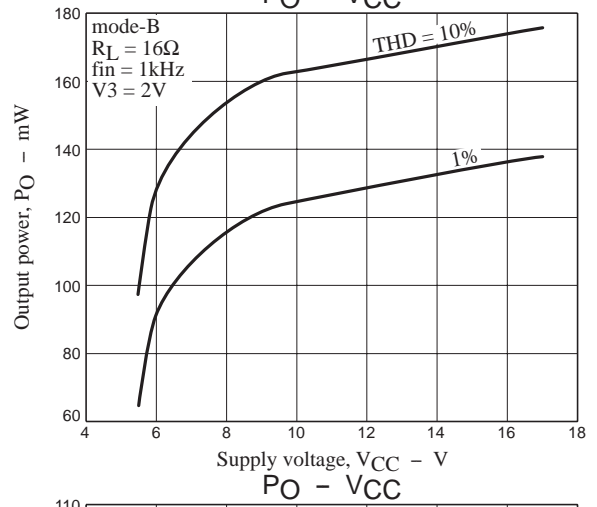
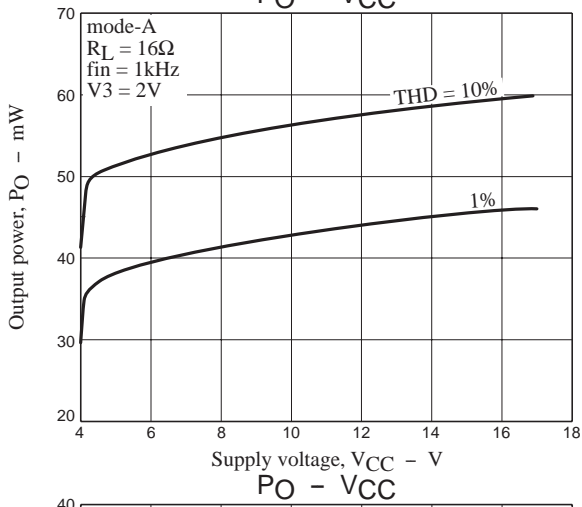
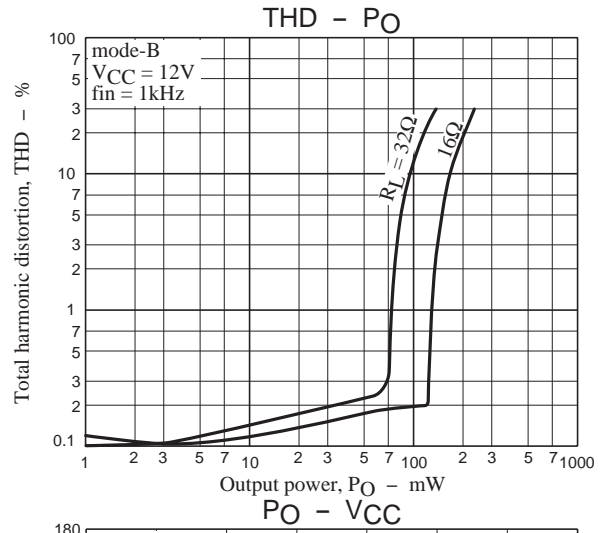
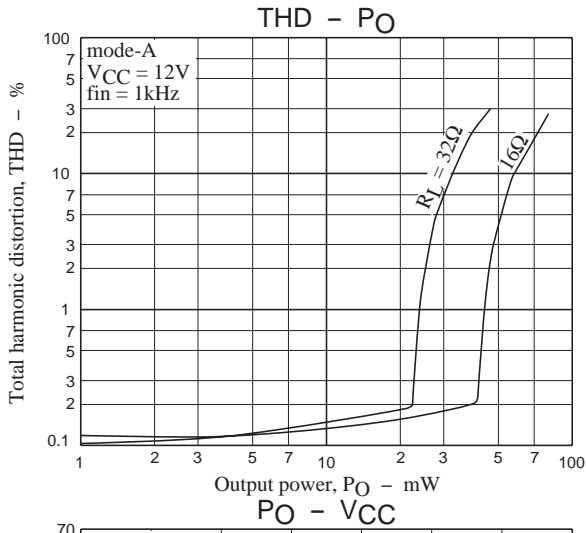

LA4809M

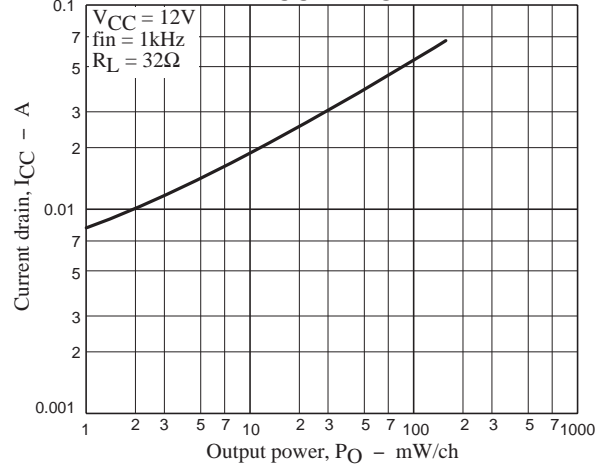
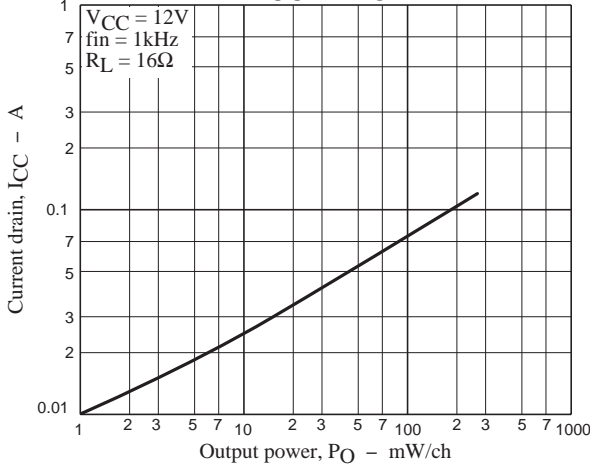
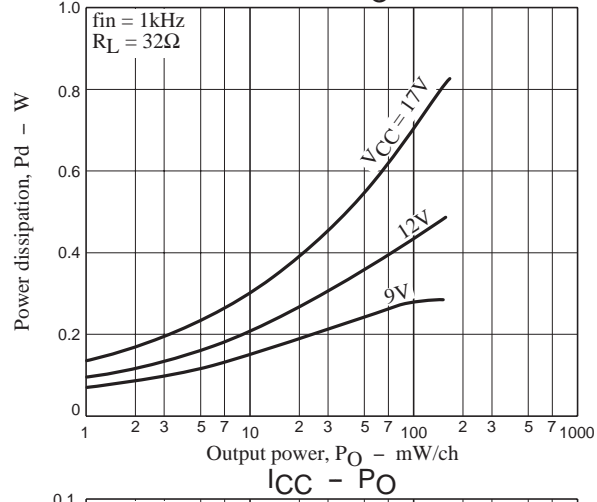
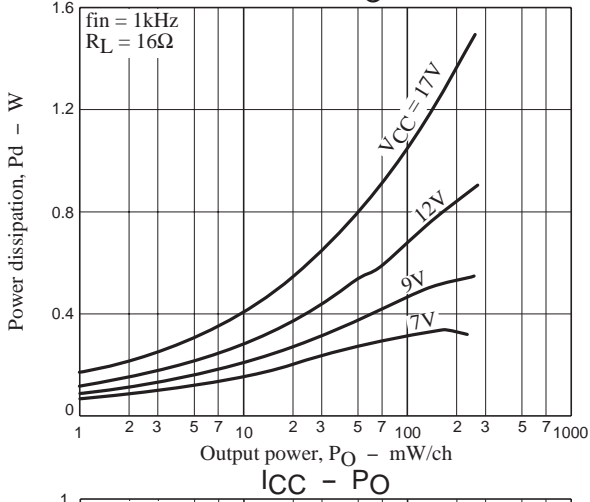
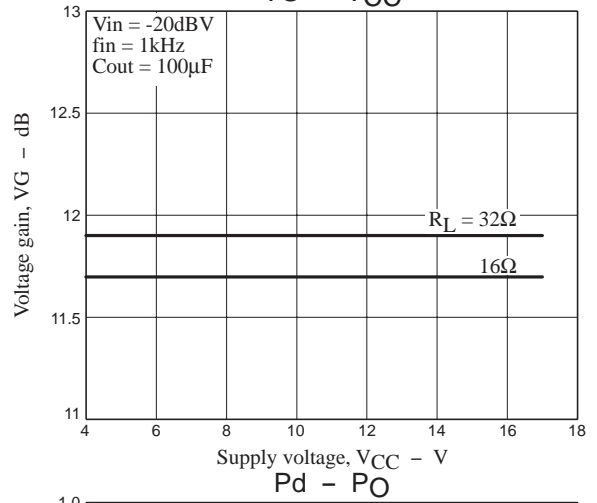
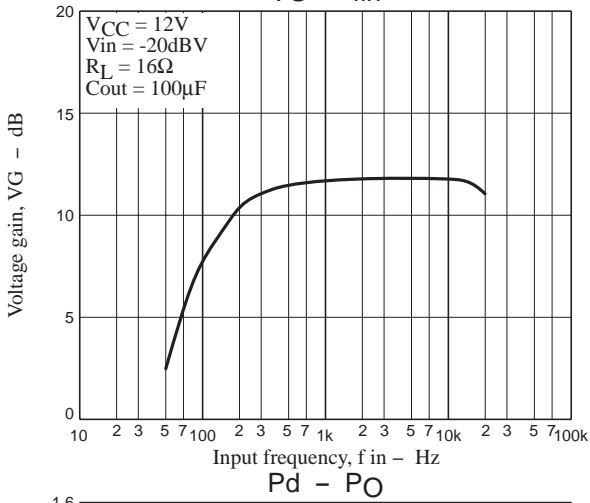
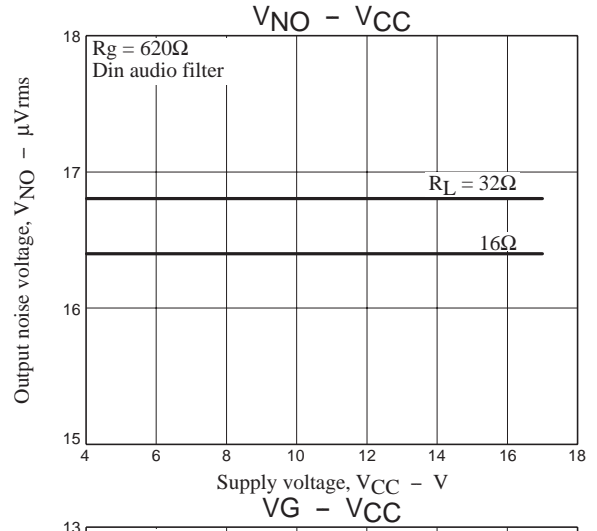
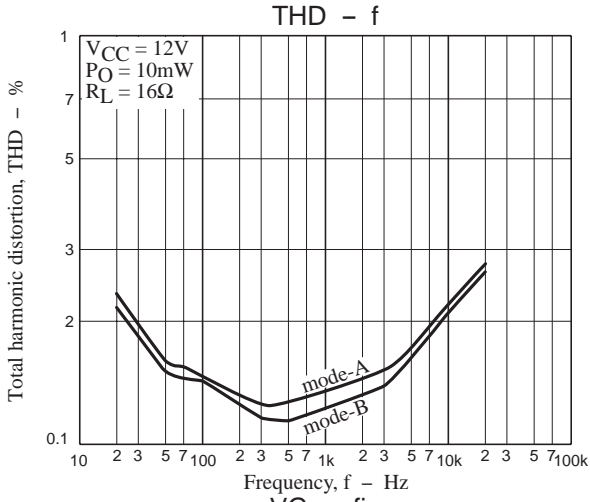

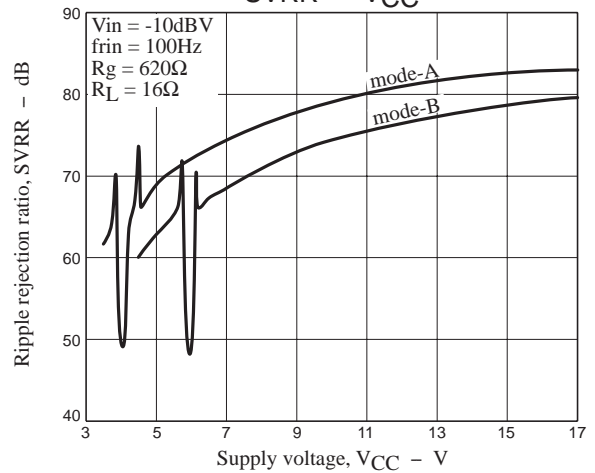
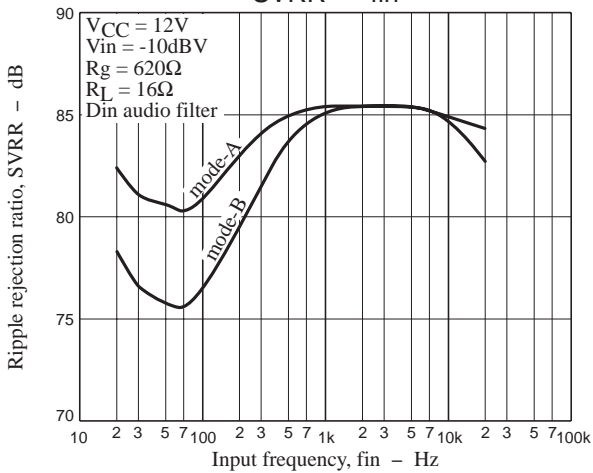
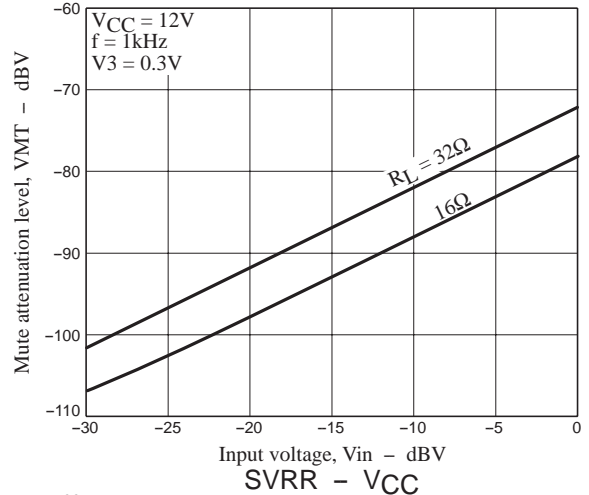
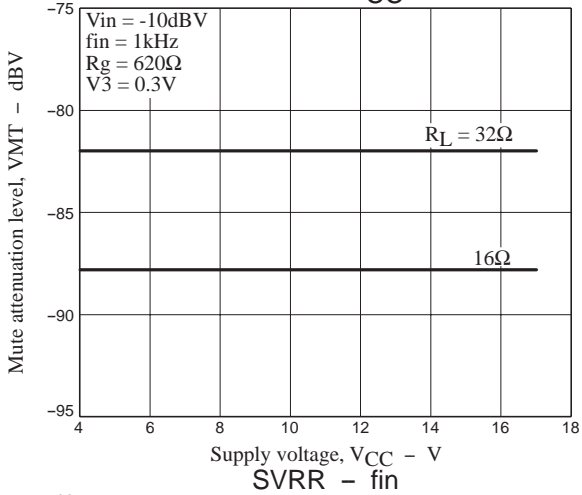
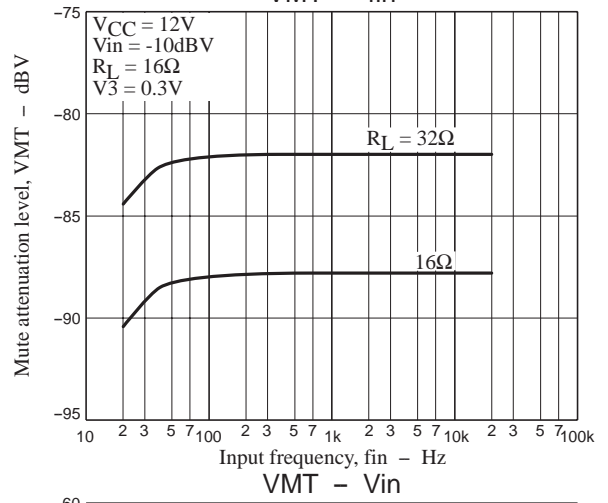
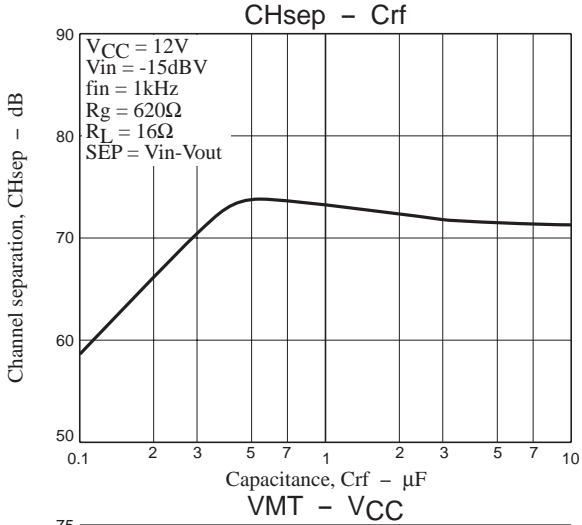
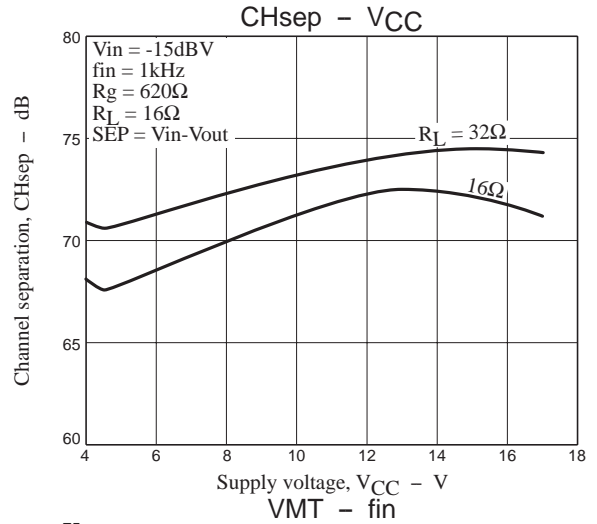
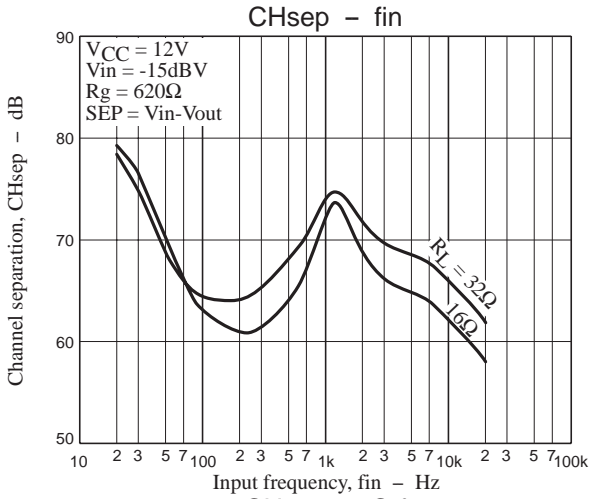

LA4809M

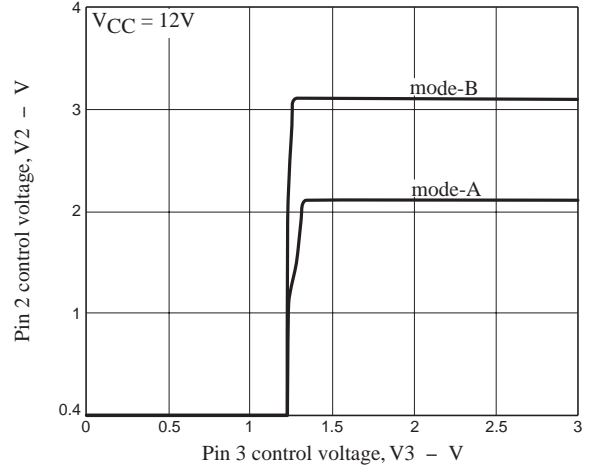
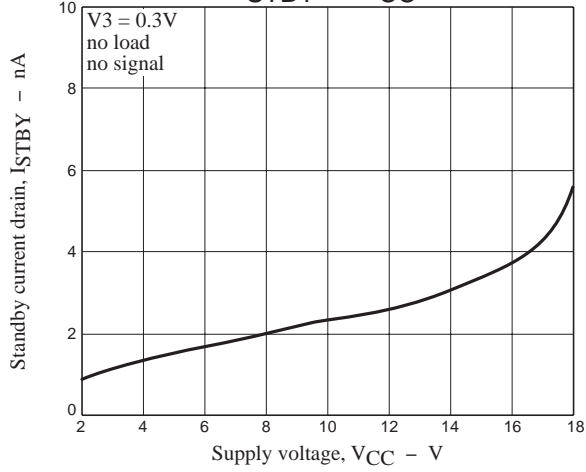
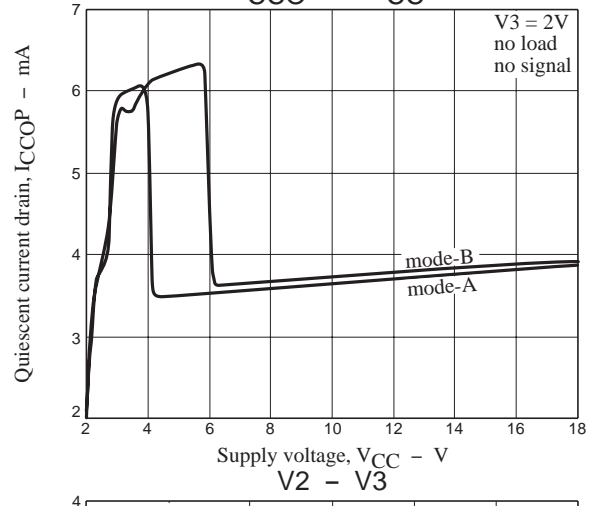
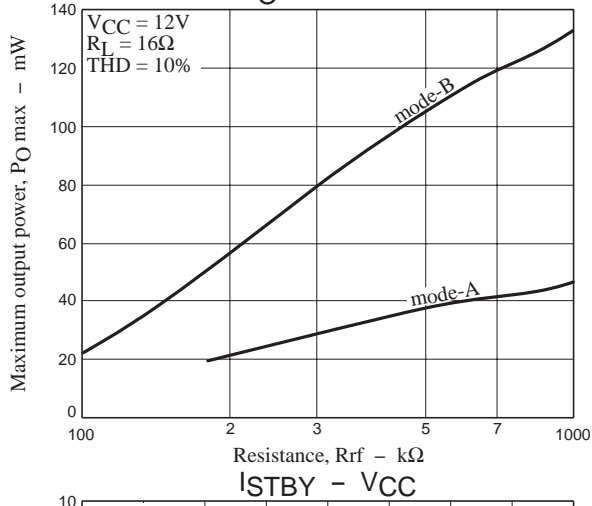
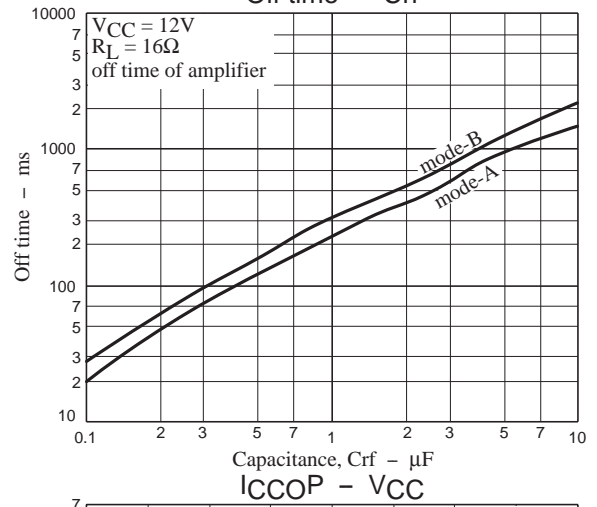
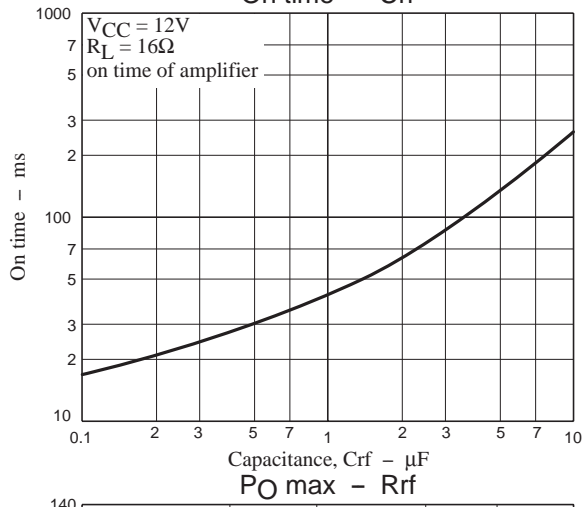
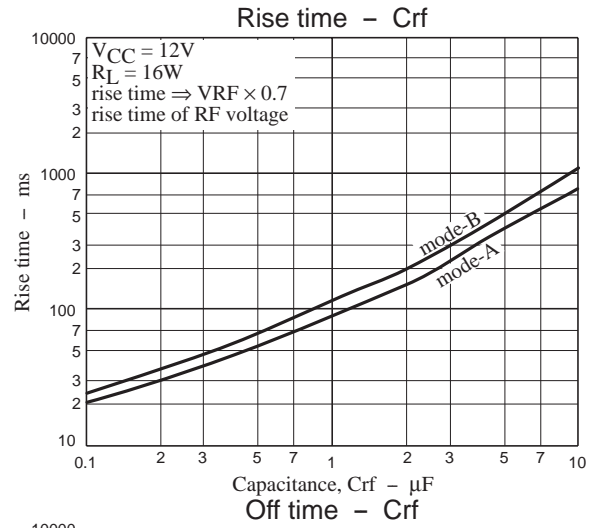
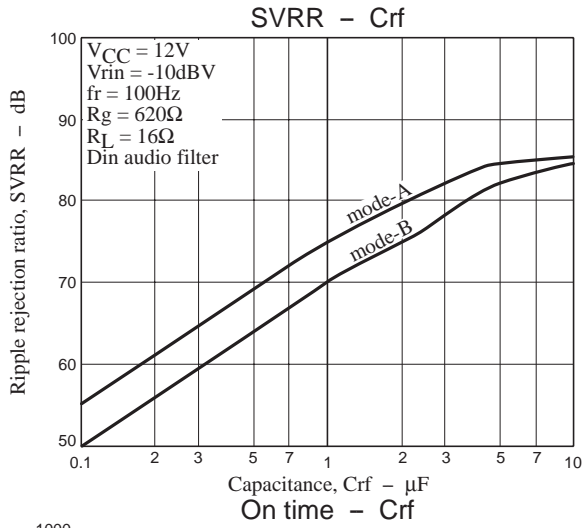

LA4809M

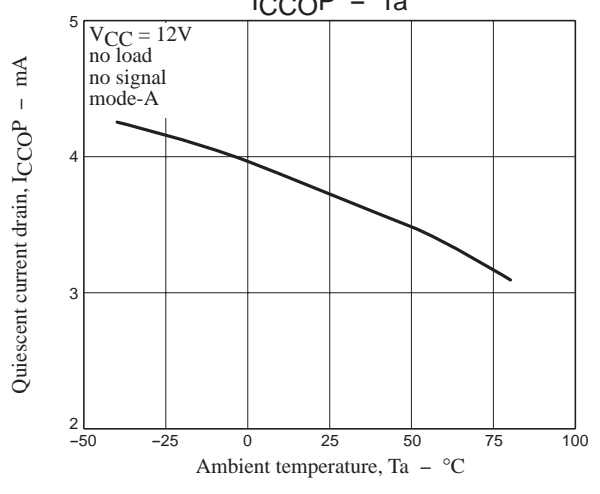
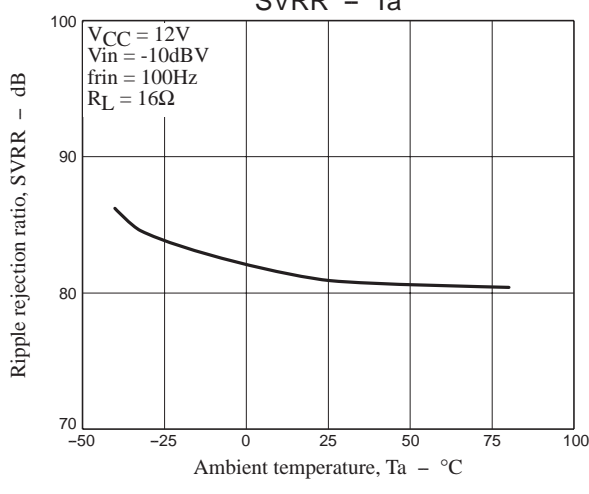
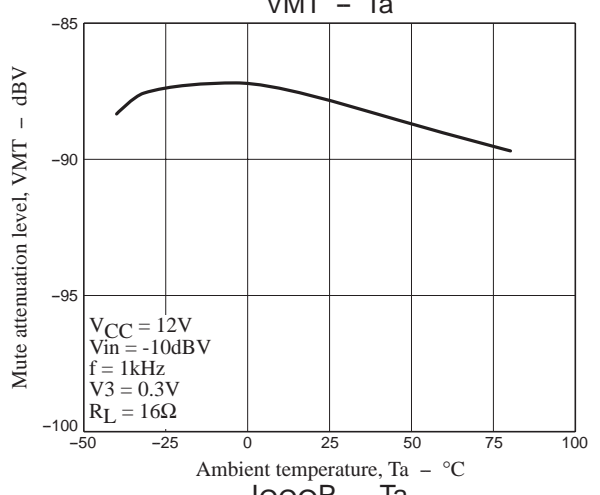
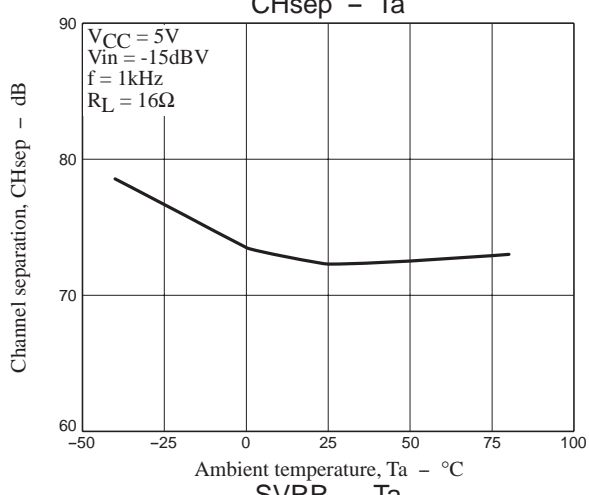
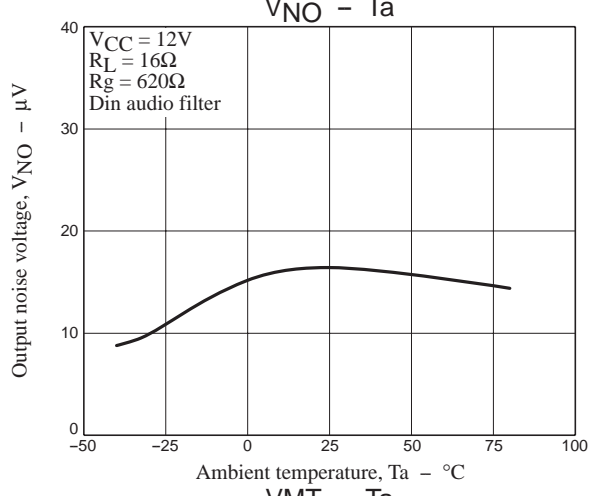
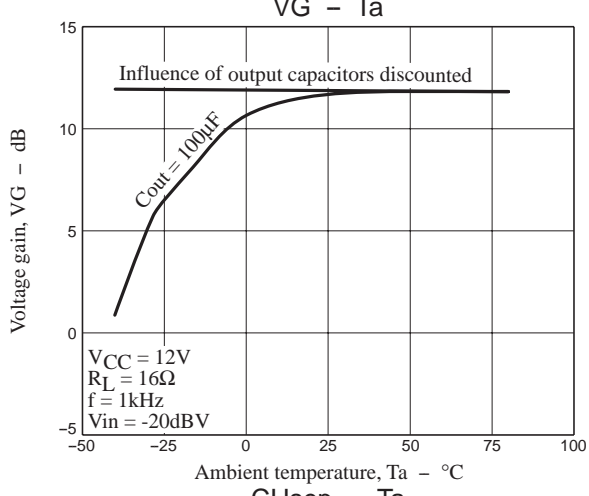
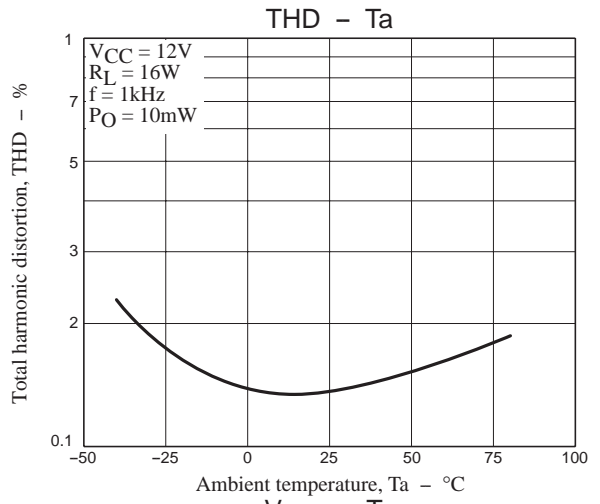
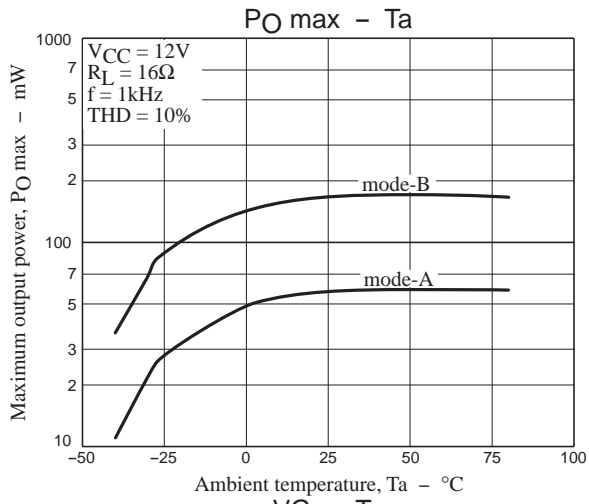

LA4809M

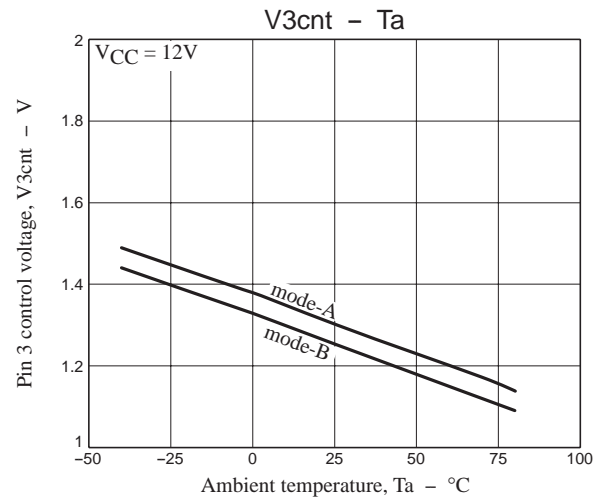
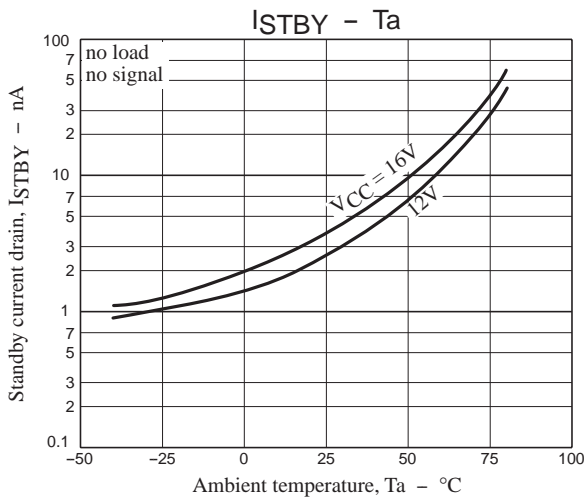

•Transient response characteristics (Rising characteristics)

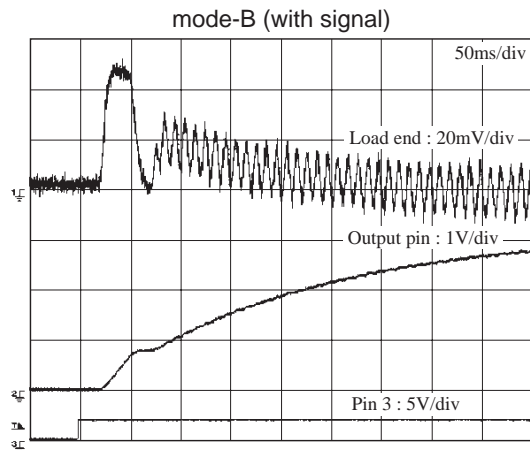
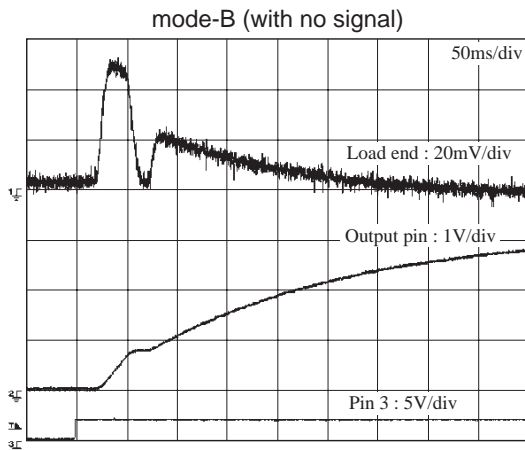
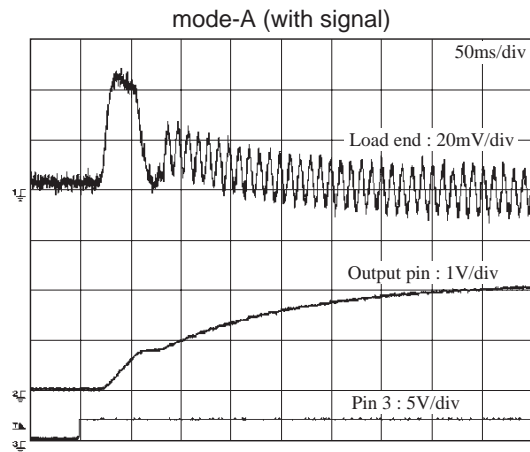
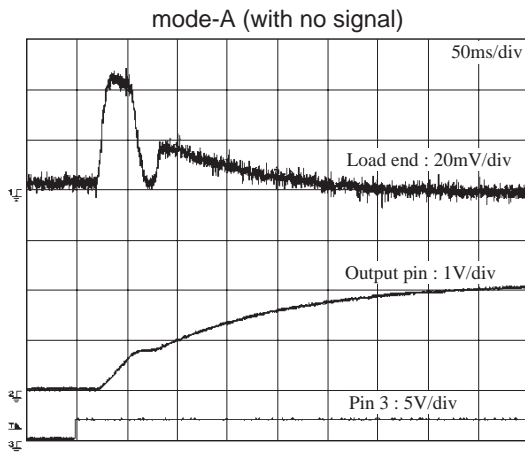

LA4809M

•Transient response characteristics (Falling characteristics)

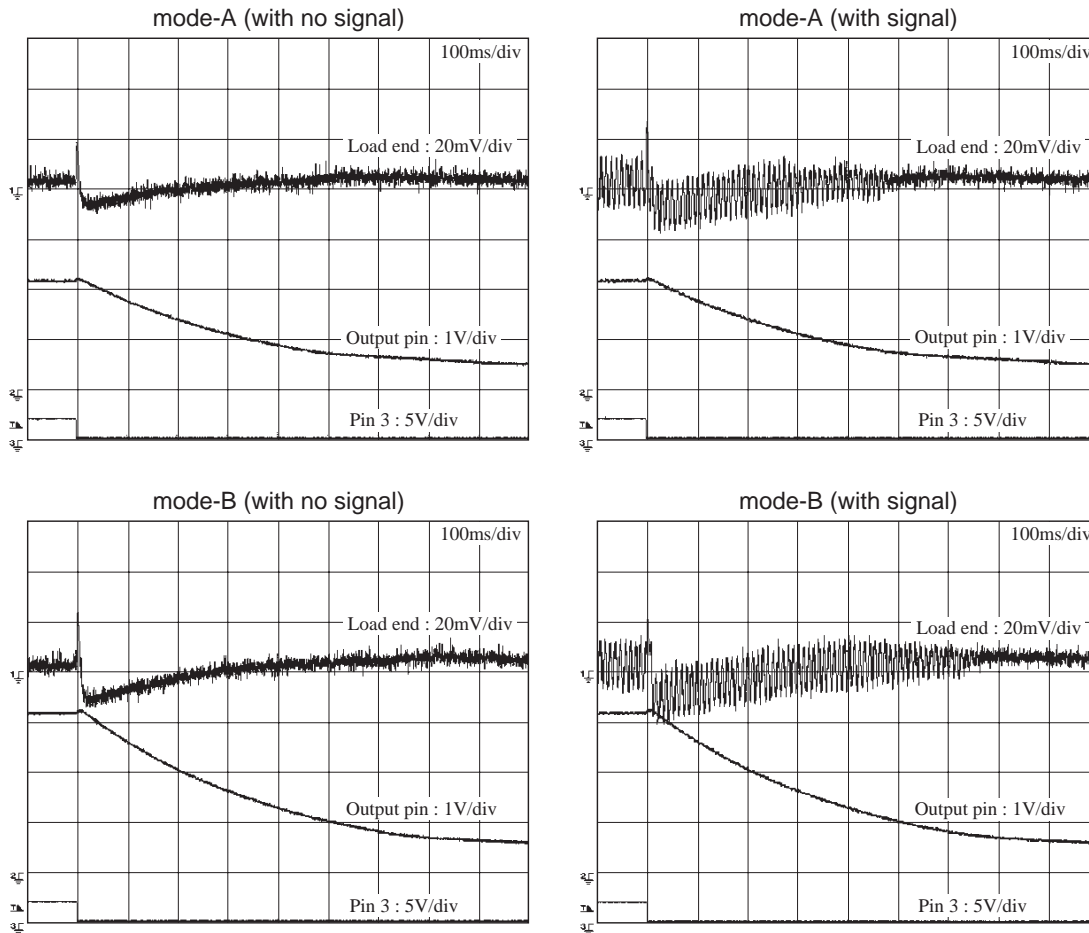

- SANYO Semiconductor Co.,Ltd. assumes no responsibility for equipment failures that result from using products at values that exceed, even momentarily, rated values (such as maximum ratings, operating condition ranges, or other parameters) listed in products specifications of any and all SANYO Semiconductor Co.,Ltd. products described or contained herein.
- SANYO Semiconductor Co.,Ltd. strives to supply high-quality high-reliability products, however, any and all semiconductor products fail or malfunction with some probability. It is possible that these probabilistic failures or malfunction could give rise to accidents or events that could endanger human lives, trouble that could give rise to smoke or fire, or accidents that could cause damage to other property. When designing equipment, adopt safety measures so that these kinds of accidents or events cannot occur. Such measures include but are not limited to protective circuits and error prevention circuits for safe design, redundant design, and structural design.
- In the event that any or all SANYO Semiconductor Co.,Ltd. products described or contained herein are controlled under any of applicable local export control laws and regulations, such products may require the export license from the authorities concerned in accordance with the above law.
- No part of this publication may be reproduced or transmitted in any form or by any means, electronic or mechanical, including photocopying and recording, or any information storage or retrieval system, or otherwise, without the prior written consent of SANYO Semiconductor Co.,Ltd.
- Any and all information described or contained herein are subject to change without notice due to product/technology improvement, etc. When designing equipment, refer to the "Delivery Specification" for the SANYO Semiconductor Co.,Ltd. product that you intend to use.
- Information (including circuit diagrams and circuit parameters) herein is for example only; it is not guaranteed for volume production.
- Upon using the technical information or products described herein, neither warranty nor license shall be granted with regard to intellectual property rights or any other rights of SANYO Semiconductor Co.,Ltd. or any third party. SANYO Semiconductor Co.,Ltd. shall not be liable for any claim or suits with regard to a third party's intellectual property rights which has resulted from the use of the technical information and products mentioned above.

This catalog provides information as of October, 2009. Specifications and information herein are subject to change without notice.