

GJ1202

PNP EPITAXIAL PLANAR SILICON TRANSISTOR

Description

The GJ1202 is designed for voltage regulators, relay drivers, lamp drivers and electrical equipment applications.

Features

- *Large current capacitance and wide ASO
- *Low collector-to-emitter saturation voltage
- *Fast switching speed

Package Dimensions

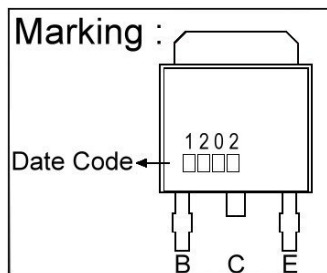
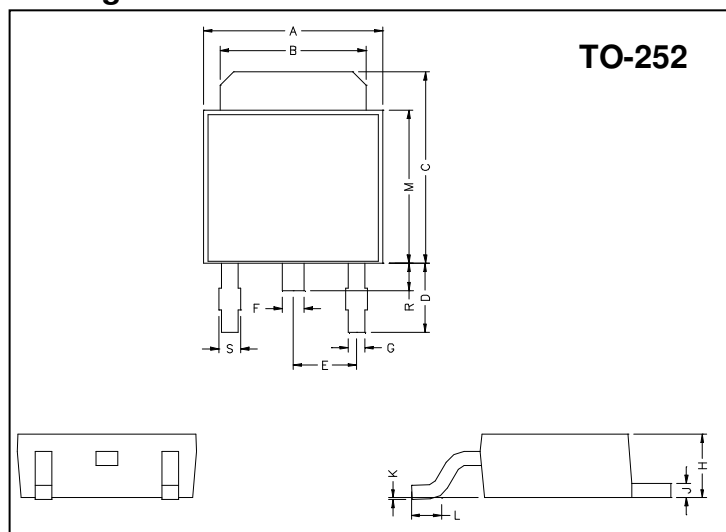

REF.	Millimeter		REF.	Millimeter	
	Min.	Max.		Min.	Max.
A	6.40	6.80	G	0.50	0.70
B	5.20	5.50	H	2.20	2.40
C	6.80	7.20	J	0.45	0.55
D	2.40	3.00	K	0	0.15
E	2.30 REF.		L	0.90	1.50
F	0.70	0.90	M	5.40	5.80
S	0.60	0.90	R	0.80	1.20

Absolute Maximum Ratings (Ta = 25°C, unless otherwise specified)

Parameter	Symbol	Ratings	Unit
Collector to Base Voltage	V _{CB0}	-60	V
Collector to Emitter Voltage	V _{CEO}	-50	V
Emitter to Base Voltage	V _{EB0}	-6	V
Collector Current	I _C	-3	A
Collector Current(Pulse)	I _{CP}	-6	A
Junction Temperature	T _j	+150	°C
Storage Temperature	T _{STG}	-55 ~ +150	°C
Total Power Dissipation	P _D	1	W
	P _D (T _C =25°C)	15	W

Electrical Characteristics (Rating at Ta=25°C)

Symbol	Min.	Typ.	Max.	Unit	Test Conditions
V _{CB0}	-60	-	-	V	I _C =-10uA, I _E =0
V _{CEO}	-50	-	-	V	I _C =-1mA, R _{BE} =∞
V _{EB0}	-6	-	-	V	I _E =-10uA, I _C =0
I _{CB0}	-	-	-1	uA	V _{CB} =-40V, I _E =0
I _{EB0}	-	-	-1	uA	V _{EB} =-4V, I _C =0
*V _{CE(sat)1}	-	-0.35	-0.7	V	I _C =-2A, I _B =-100mA
*V _{BE(sat)}	-	-0.94	-1.2	V	I _C =-2A, I _B =-100mA
*h _{FE1}	100	-	560		V _{CE} =-2V, I _C =-100mA
*h _{FE2}	35	-	-		V _{CE} =-2V, I _C =-3A
f _T	-	150	-	MHz	V _{CE} =-10V, I _C =-50mA
C _{ob}	-	39	-	pF	V _{CB} =-10V, f=1MHz
t _{on} (Turn-On Time)	-	70	-	ns	See specified test circuit.
t _{stg} (Storage Time)	-	450	-	ns	See specified test circuit.
t _f (Fall Time)	-	35	-	ns	See specified test circuit.

* Pulse Test: Pulse Width ≤ 380μs, Duty Cycle ≤ 2%

Classification Of hFE1

Rank	R	S	T	U
Range	100 ~ 200	140 ~ 280	200 ~ 400	280 ~ 560

Switching Time Test Circuit

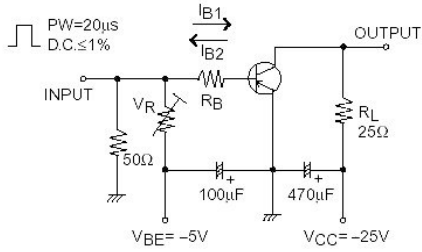

$$I_C = 10 I_{B1} = -10 I_{B2} = 1A$$

Characteristics Curve

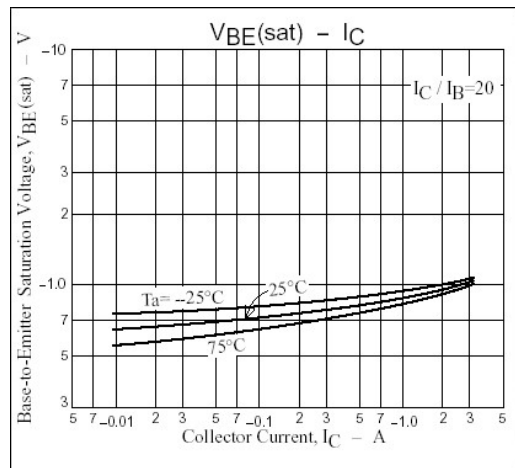
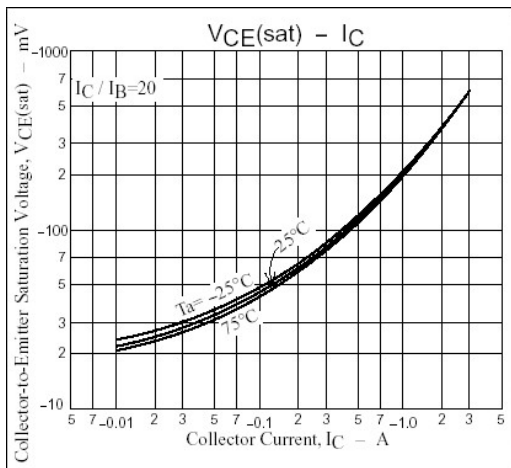
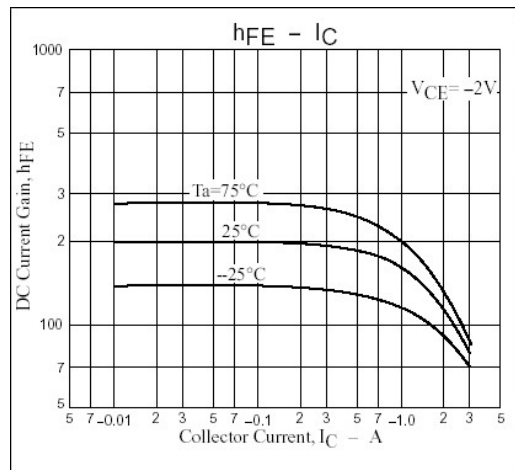
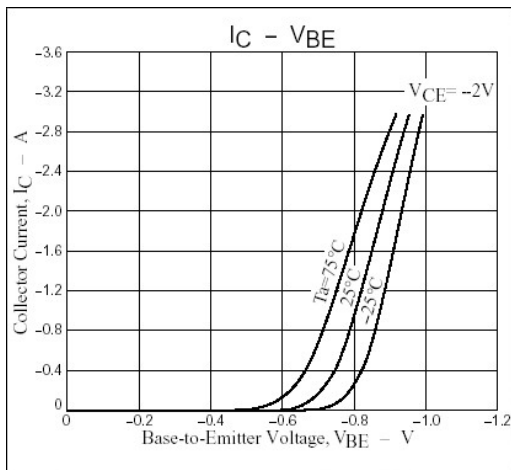
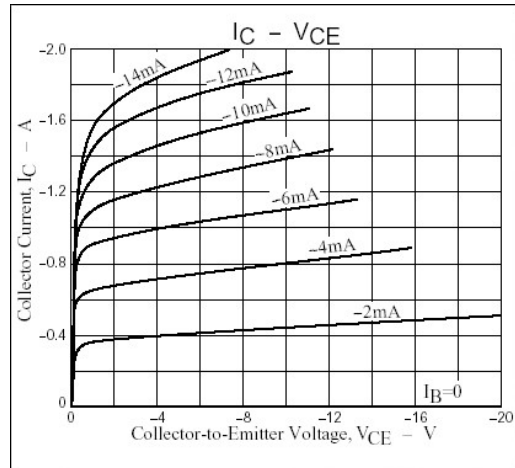
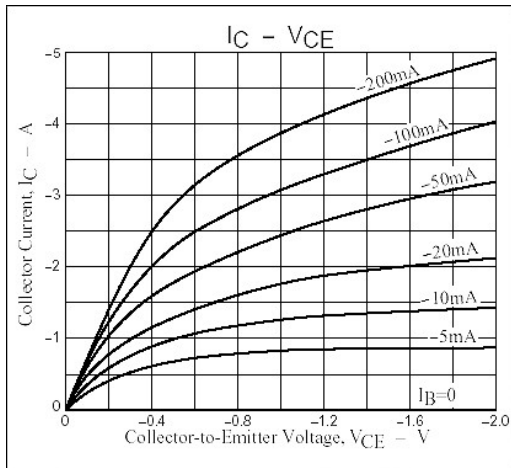

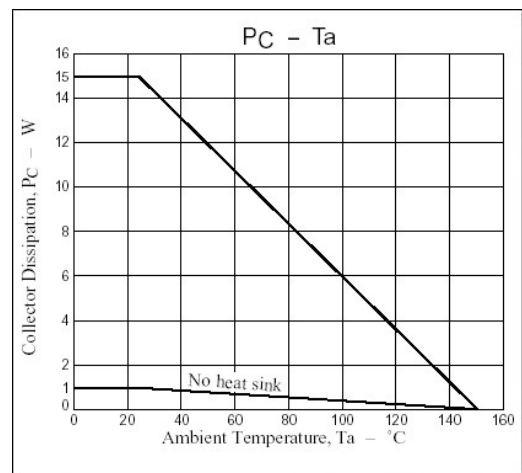
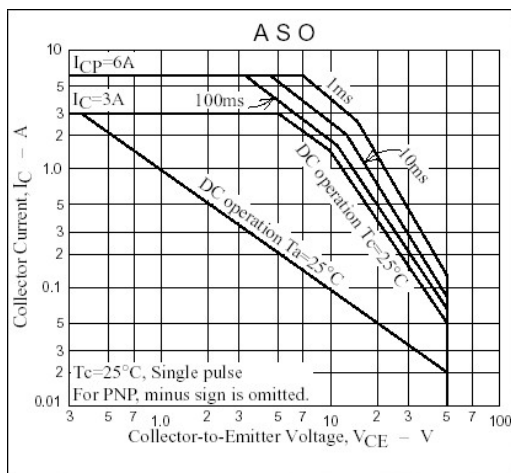
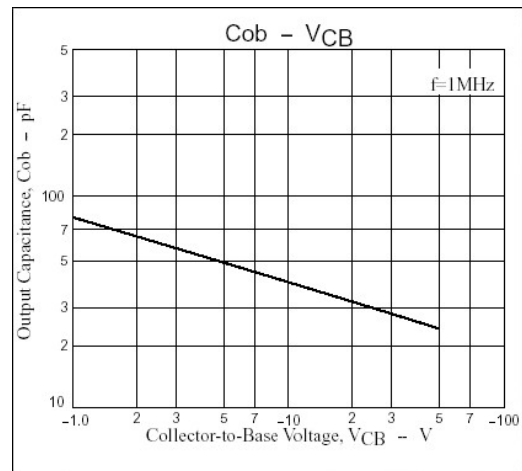
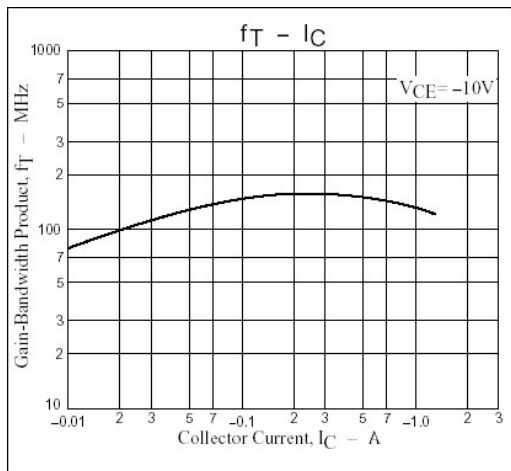

Important Notice:

- All rights are reserved. Reproduction in whole or in part is prohibited without the prior written approval of GTM.
- GTM reserves the right to make changes to its products without notice.
- GTM semiconductor products are not warranted to be suitable for use in life-support Applications, or systems.
- GTM assumes no liability for any consequence of customer product design, infringement of patents, or application assistance.

Head Office And Factory:

- **Taiwan:** No. 17-1 Tatung Rd. Fu Kou Hsin-Chu Industrial Park, Hsin-Chu, Taiwan, R. O. C.
- TEL : 886-3-597-7061 FAX : 886-3-597-9220, 597-0785
- **China:** (201203) No.255, Jang-Jiang Tsai-Lueng RD. , Pu-Dung-Hsin District, Shang-Hai City, China
- TEL : 86-21-5895-7671 ~ 4 FAX : 86-21-38950165