

# SHINDENGEN

## Super Fast Recovery Rectifiers

Single

# D5L60

## 600V 5A

### FEATURES

- High Voltage
- trr50ns
- Fully Isolated Molding
- Dielectric strength 1.5kV guaranteed

### APPLICATION

- PFC
- Switching power supply
- Free Wheel
- CTV+B output, lighting

### OUTLINE DIMENSIONS

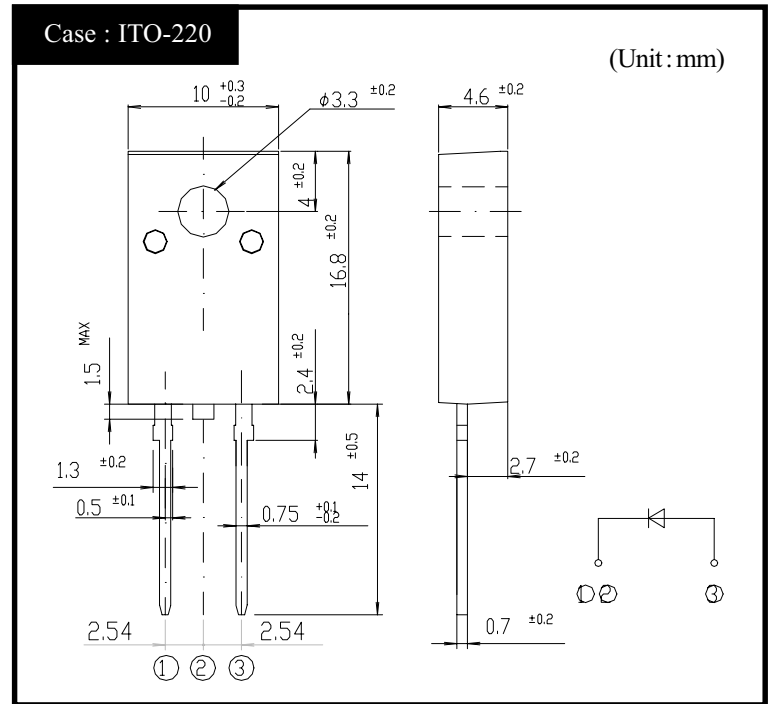

### RATINGS

#### ● Absolute Maximum Ratings (If not specified Tc=25°C)

Item	Symbol	Conditions	Ratings	Unit
Storage Temperature	Tstg		-55~150	°C
Operating Junction Temperature	Tj		150	°C
Maximum Reverse Voltage	V <sub>RM</sub>		600	V
Average Rectified Forward Current	I <sub>O</sub>	50Hz sine wave, R-load, Tc=123°C	5	A
Peak Surge Forward Current	I <sub>FSM</sub>	50Hz sine wave, Non-repetitive 1 cycle peak value, Tj=25°C	100	A
Dielectric Strength	V <sub>dis</sub>	Terminals to case, AC 1 minute	1.5	kV
Mounting Torque	TOR	(Recommended torque: 0.3N·m)	0.5	N·m

#### ● Electrical Characteristics (If not specified Tc=25°C)

Item	Symbol	Conditions	Ratings	Unit
Forward Voltage	V <sub>F</sub>	I <sub>F</sub> =5A, Pulse measurement	Max 1.5	V
Reverse Current	I <sub>R</sub>	V <sub>R</sub> =V <sub>RM</sub> , Pulse measurement	Max 10	μA
Reverse Recovery Time	trr	I <sub>F</sub> =0.5A, I <sub>R</sub> =1A	Max 50	ns
Thermal Resistance	θ <sub>jc</sub>	junction to case	Max 3.5	°C/W
	θ <sub>jf</sub>	junction to heatsink (Reference value)	Max 5.0	

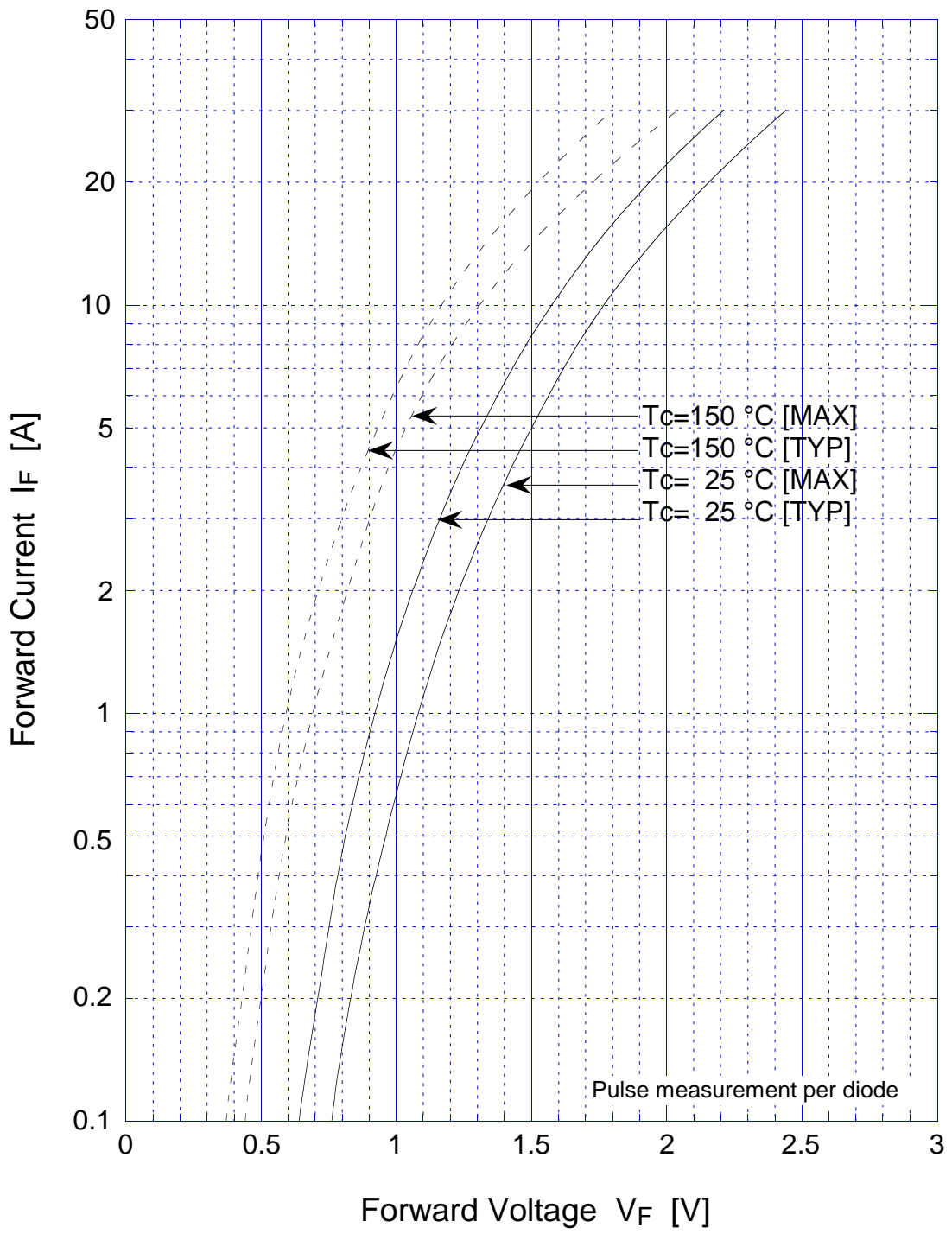

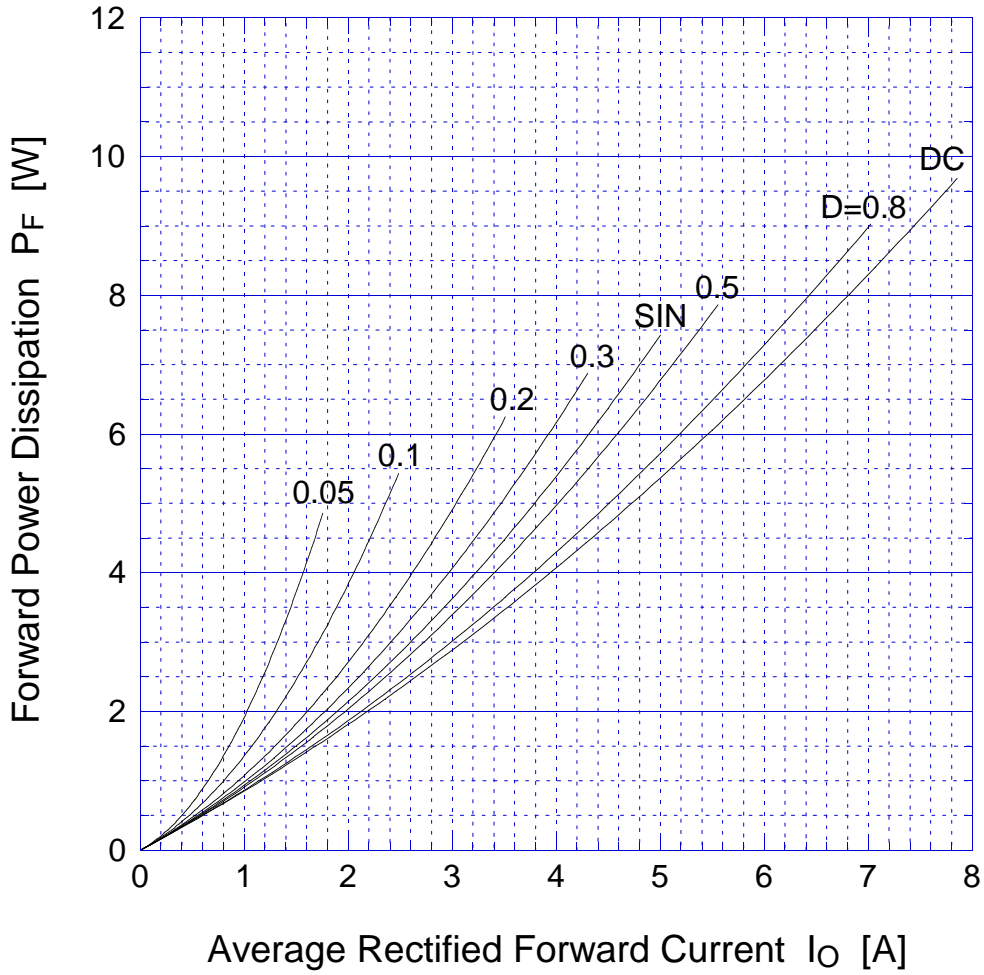

$T_j = 150^\circ\text{C}$

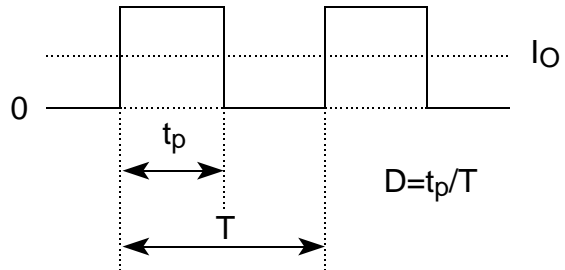

# D5L60

## Peak Surge Forward Capability

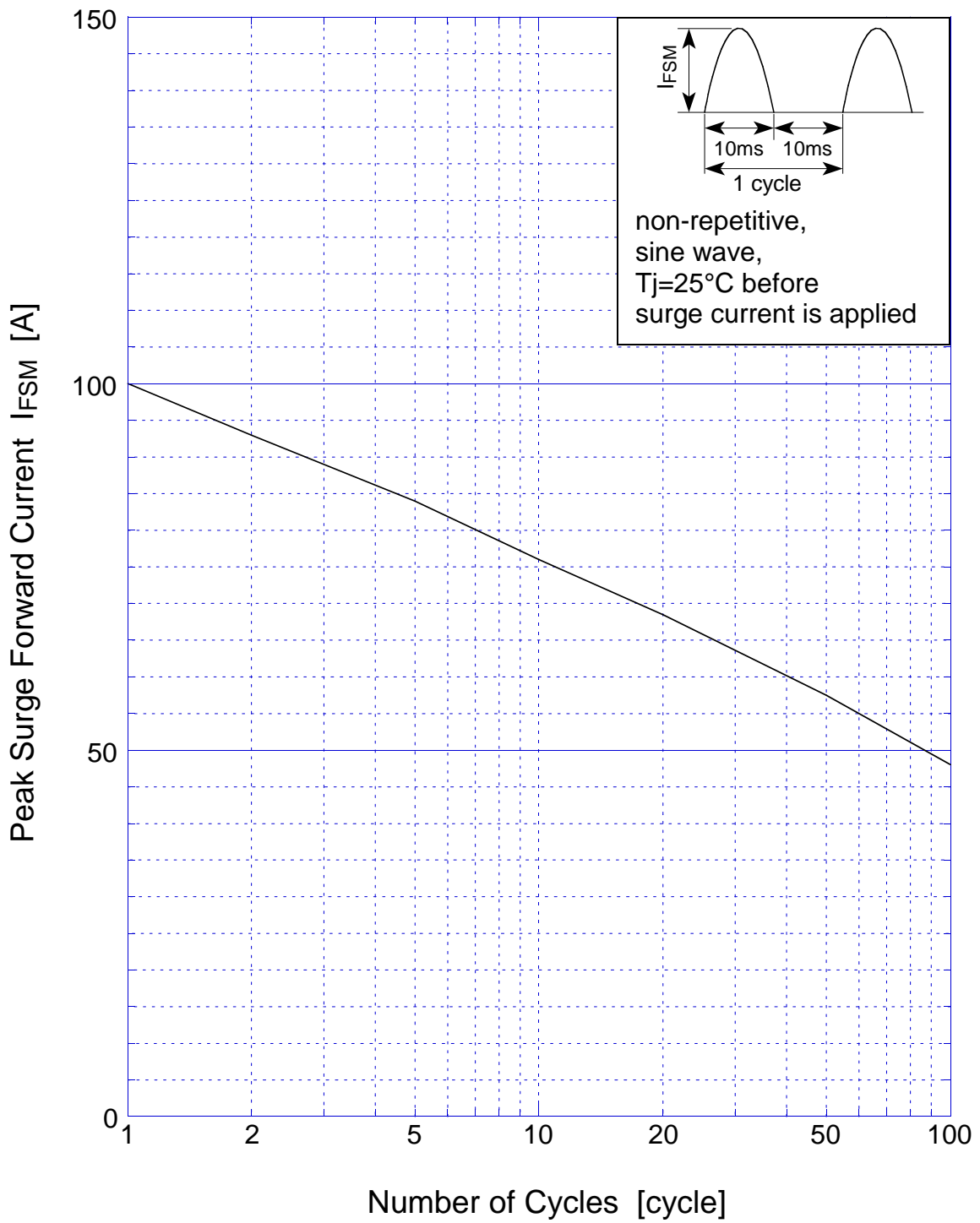

# D5L60 Junction Capacitance

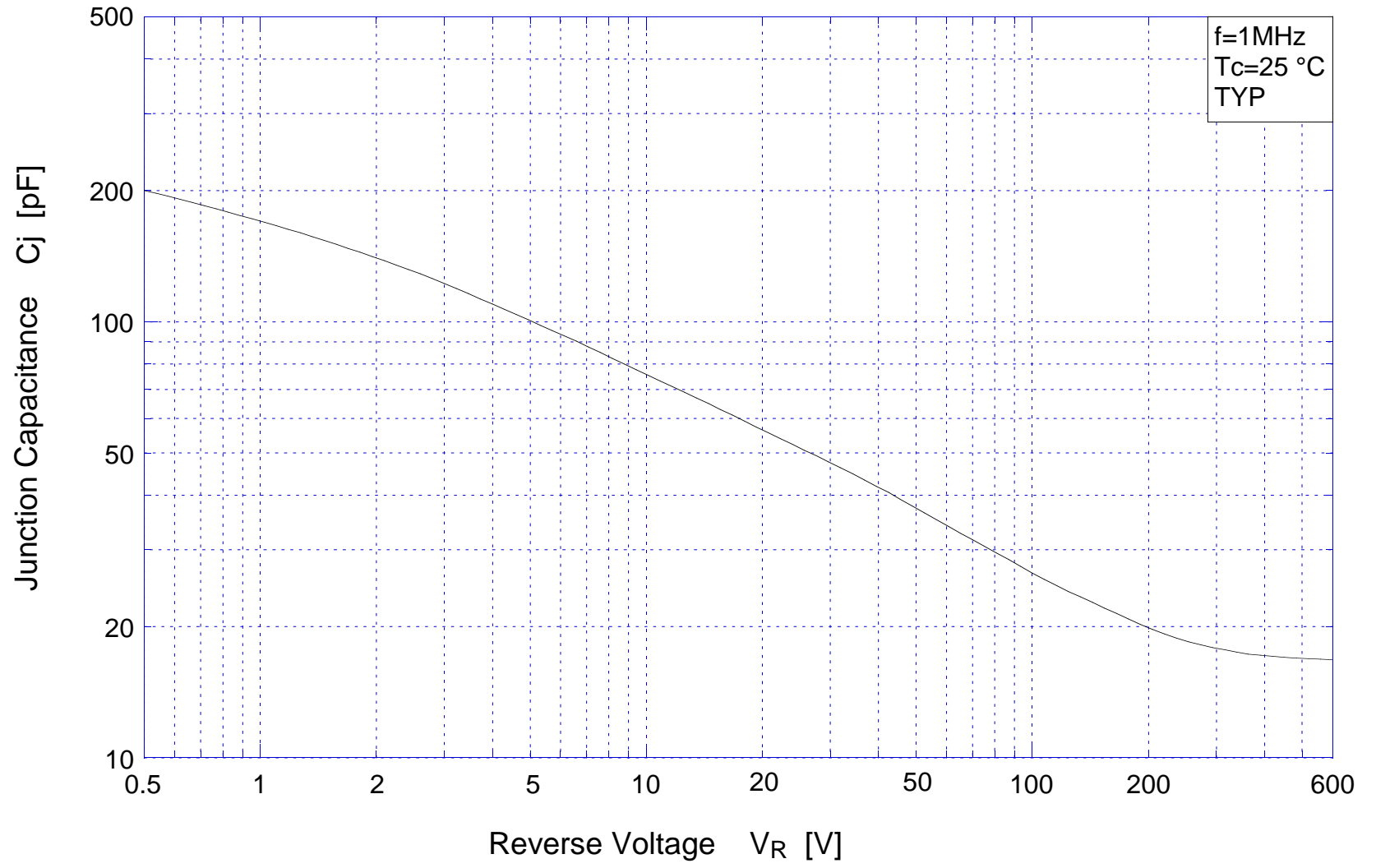

# D5L60

# Derating Curve

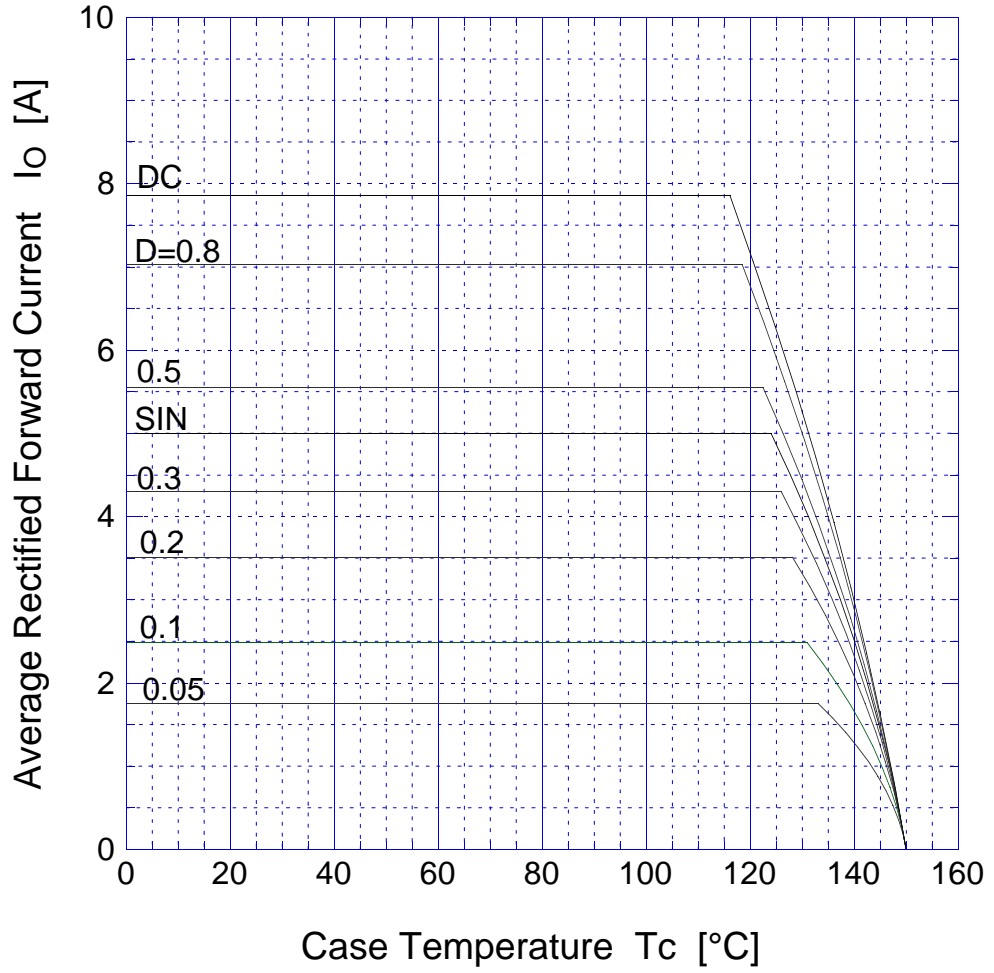

$$V_R = V_{RM}$$

