

### Dual N-Channel MOSFET

 Lead(Pb)-Free

#### Features:

- \* Low On-Resistance
- \* Fast Switching Speed
- \* Low-voltage drive
- \* Easily designed drive circuits
- \* ESD Protected:2000V

#### Mechanical Data:

- \*Case: SOT-363, Molded Plastic
- \*Case Material-UL Flammability Rating 94V-0
- \*Terminals: Solderable per MIL-STD-202, Method 208
- \*Weight: 0.006 grams(approx.)

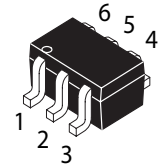

**SOT-363(SC-88)**

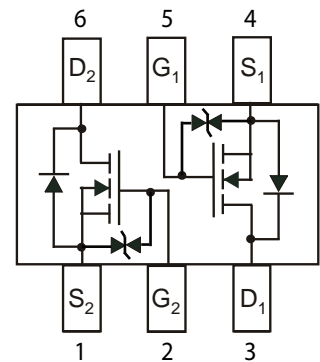

### Maximum Ratings (TA=25°C Unless Otherwise Specified)

Rating	Symbol	Value	Unit
Drain-Source Voltage	$V_{DS}$	60	V
Gate-Source Voltage	$V_{GS}$	$\pm 20$	V
Drain Current	Continuous	$I_D$	115
	Pulsed	$I_{DP}^{*1}$	800
Reverse Drain Current	Continuous	$I_D$	115
	Pulsed	$I_{DRP}^{*1}$	800
Power Dissipation (TA=25°C)	$P_D$	225	mW
Operating Junction and Storage Temperature Range	$T_J, T_{stg}$	-55 to 150	°C

### Device Marking

2N7002KDW=RK

#### Note

- \*1  $P_w \leq 10 \mu s$ , Duty cycle  $\leq 1\%$
- \*2 When mounted on a 1\*0.75\*0.062 inch glass epoxy board

## Electrical Characteristics @ $T_A=25$ unless otherwise specified, per element

Characteristic	Symbol	Min	Typ	MAX	Unit
----------------	--------	-----	-----	-----	------

### OFF CHARACTERISTICS

Drain-Source Breakdown Voltage	$V_{GS}=0V, I_D=10\mu A$	$V_{(BR)DSS}$	60	-	-	V
Zero Gate Voltage Drain Current	$V_{DS}=60V, V_{GS}=0V$	$I_{DSS}$	-	-	1.0	$\mu A$
Gate-source Leakage	$V_{GS}=\pm 20V, V_{DS}=0V$	$I_{GSS}$	-	-	$\pm 10$	$\mu A$

### ON CHARACTERISTICS

Gate Threshold Voltage	$V_{DS}=V_{GS}, I_D=250\mu A$	$V_{GS(th)}$	1.0	1.85	2.5	V
Static Drain-Source On-Resistance	$V_{GS}=10V, I_D=0.5A$	$R_{DS(ON)}$	-	-	7.5	$\Omega$
	$V_{GS}=5V, I_D=0.05A$		-	-	7.5	
Forward transfer admittance	$V_{DS}=10V, I_D=0.2A$	$g_{fs}^*$	80	-	-	mS

### DYNAMIC CHARACTERISTICS

Input Capacitance	$V_{DS}=25V$	$C_{iSS}$	-	25	50	pF
Output Capacitance	$V_{GS}=0V$	$C_{oSS}$	-	10	25	pF
Reverse Transfer Capacitance	$f=1.0MHz$	$C_{rSS}$	-	3.0	5.0	pF

### SWITCHING CHARACTERISTICS

Turn-On Delay Time	$I_D=0.2A, V_{DD}=30V,$	$T_{D(ON)}^*$	-	12	20	nS
Turn-Off Delay Time	$V_{GS}=10V, R_L=150\Omega, R_G=10\Omega$	$T_{D(OFF)}^*$	-	20	30	nS

\*  $P_w \leq 300\mu s$ , Duty cycle  $\leq 1\%$

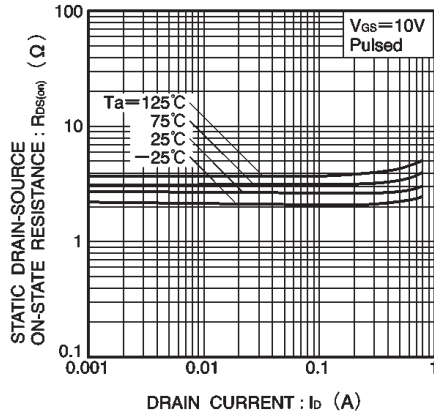

Fig.4 Static drain-source on-state resistance vs. drain current ( I )

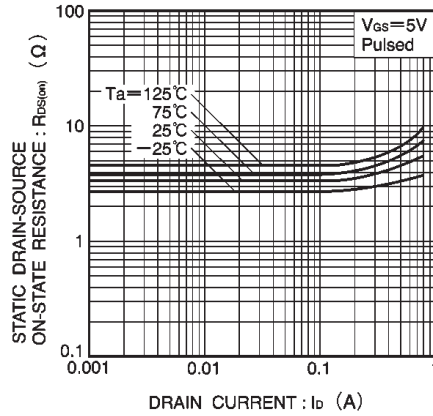

Fig.5 Static drain-source on-state resistance vs. drain current ( II )

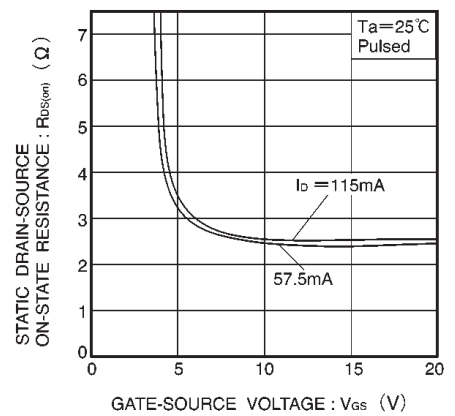

Fig.6 Static drain-source on-state resistance vs. gate-source voltage

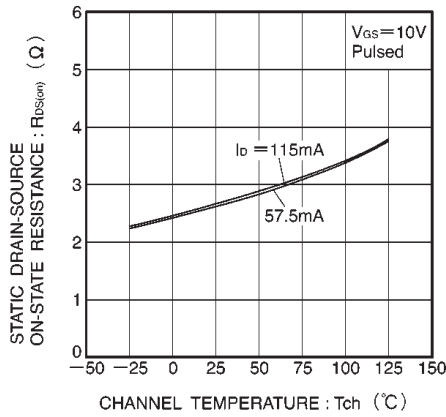

Fig.7 Static drain-source on-state resistance vs. channel temperature

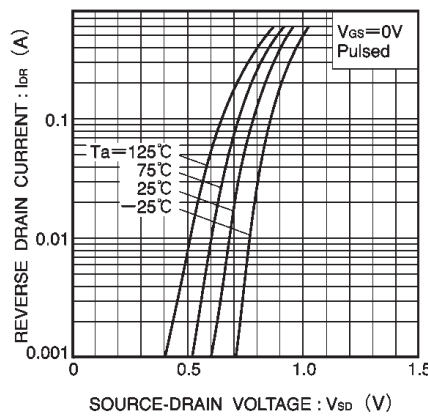

Fig.8 Reverse drain current vs. source-drain voltage ( I )

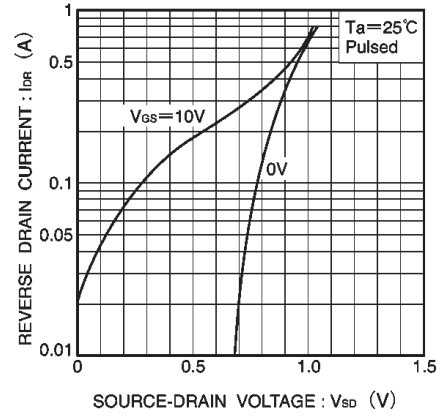

Fig.9 Reverse drain current vs. source-drain voltage ( II )

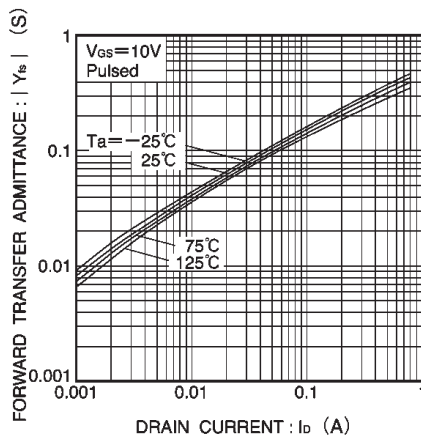

Fig.10 Forward transfer admittance vs. drain current

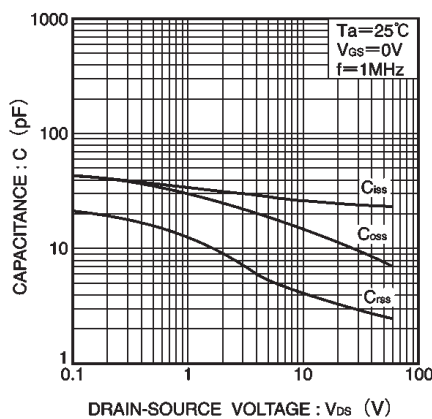

Fig.11 Typical capacitance vs. drain-source voltage

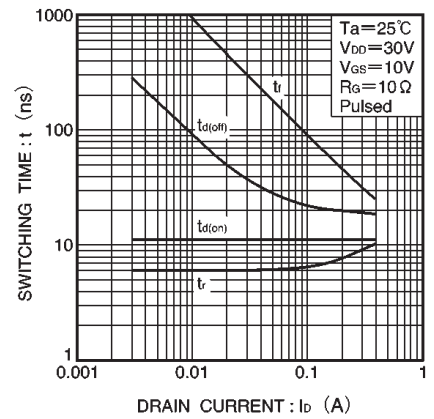
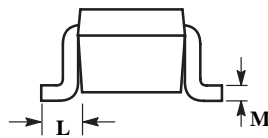
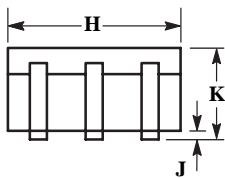
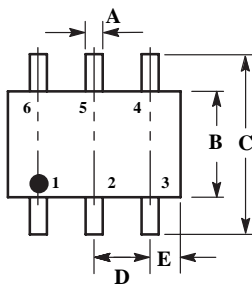

Fig.12 Switching characteristics (See Figures 13 and 14 for the measurement circuit and resultant waveforms)

**SOT-363 Outline Dimensions**

Unit:mm



SOT-363		
Dim	Min	Max
A	0.10	0.30
B	1.15	1.35
C	2.00	2.20
D	0.65 REF	
E	0.30	0.40
H	1.80	2.20
J	-	0.10
K	0.80	1.10
L	0.25	0.40
M	0.10	0.25