

VI TELEFILTER**Filter specification****TFS 115D****1/5****Measurement condition**

Ambient temperature:	20	°C
Input power level:	0	dBm
Terminating impedance: *		
Input:	313 Ω	-24 pF
Output:	268 Ω	-29 pF

Characteristics**Remark:**

The reference level for the relative attenuation a_{rel} of the TFS 115D is the minimum of the pass band attenuation a_{min} . The minimum of the pass band attenuation a_{min} is defined as the insertion loss a_e . The centre frequency f_c is the arithmetic mean value of the upper and lower frequencies at the 1 dB filter attenuation level relative to the insertion loss a_e . The nominal frequency f_N is fixed at 115,2 MHz without any tolerance. The given values for both the relative attenuation a_{rel} and the group delay ripple have to be achieved at the frequencies given below even if the centre frequency f_c is shifted due to the temperature coefficient of frequency TC_f in the operating temperature range and due to a production tolerance for the centre frequency f_c .

D a t a		typ. value	tolerance / limit
Insertion loss (reference level)	a_e	6 dB	max. 10 dB
Nominal frequency	f_N		115,2 MHz
Passband	PB		$f_N \pm 1,92$ MHz
Pass band ripple	p-p	0,3 dB	max. 1 dB
Relative attenuation	a_{rel}		
f_N	$f_N \pm 1,92$ MHz	2,5 dB	max. 3 dB
$f_N \pm 4,2$ MHz	$f_N \pm 7,5$ MHz	35 dB	min. 25 dB
$f_N \pm 7,5$ MHz	$f_N \pm 12,5$ MHz	48 dB	min. 35 dB
$f_N \pm 12,5$ MHz	$f_N \pm 25$ MHz	60 dB	min. 38 dB
Absolute Group delay in PB	p-p	0,75 μ s	max. 0,85 μ s
Group delay ripple in PB	p-p	100 ns	max. 150 ns
Input power level **			max. 10 dBm
Operating temperature range	OTR		-10 °C..... +85 °C
Storage temperature range			-40 °C..... +85 °C
Temperature coefficient of frequency	TC_f ***	-22 ppm/K	-

*) The terminating impedances depend on parasitics and q-values of matching elements and the board used, and are to be understood as reference values only. Should there be additional questions do not hesitate to ask for an application note or contact our design team.

**) Maximum value for 10 years operation.

***) $\Delta f_c(\text{Hz}) = TC_f(\text{ppm/K}) \times (T - T_o) \times f_{T_o}(\text{MHz})$.

Generated:**Checked / Approved:**

Tele Filter GmbH
Potsdamer Straße 18
D 14 513 TELTOW / Germany
Tel: (+49) 3328 4784-0 / Fax: (+49) 3328 4784-30
E-Mail: tft@telefilter.com

VI TELEFILTER reserves the right to make changes to the product(s) and/or information contained herein without notice. No liability is assumed as a result of their use or application. No rights under any patent accompany the sale of any such product(s) or information.

Filter characteristic

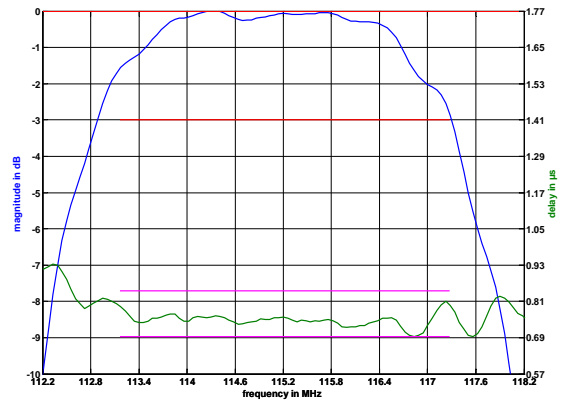
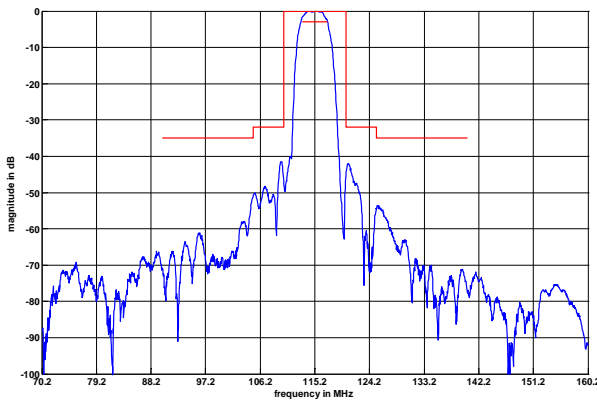

Construction and pin connection

(All dimensions in mm)

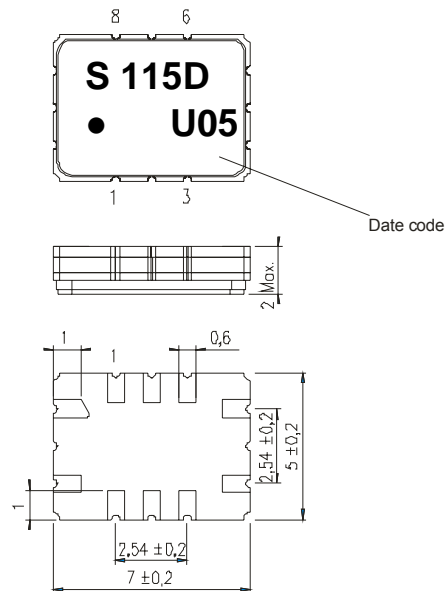

1	Ground
2	Ground
3	Ground
4	Output
5	Output RF Return
6	Ground
7	Ground
8	Ground
9	Input
10	Input RF Return

Date code: Year + week
 U 2006
 V 2007
 W 2008
 ...

50 Ohm Test circuit

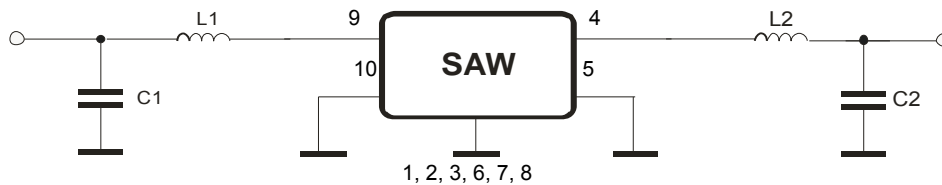

Tele Filter GmbH
 Potsdamer Straße 18
 D 14 513 TELTOW / Germany
 Tel: (+49) 3328 4784-0 / Fax: (+49) 3328 4784-30
 E-Mail: tft@telefilter.com

VI TELEFILTER reserves the right to make changes to the product(s) and/or information contained herein without notice. No liability is assumed as a result of their use or application. No rights under any patent accompany the sale of any such product(s) or information.

Stability characteristics

1. High Temperature (IEC 60068 -3-1)
1,000 hours at +85C
2. Low Temperature (IEC 60068 -3-1)
1,000 hours at - 40C
3. Humidity (IEC 60068 -2-78)
1,000 hours at 85% /85C
4. Thermal Shock (IEC60068-2-14)
-55 °C to 125°C / 30 min. each / 10 cycles
5. Vibration (IEC 60068 -2-6)
10 Hz to 500 Hz, 0,35 mm or 5g respectively, 1 octave per min, 10 cycles per plan, 3 plans
6. Shock (IEC 60068 -2-27)
500g, 1 ms, half sine wave, 3 shocks each plane
7. Reflow Profile (defined at specification)
260°C +/- 5°C for 10 seconds, 2 cycles
8. Solerability
235°C +/- 5°C for 15 seconds, 1 cycle
9. Pullability, Distortion
according to MIL-STD 883 method 2004.5 Condition D

This filter is RoHS compliant (2002/95/EG, 2005/618/EG)

Packing

Tape & Reel: IEC 286 – 3, with exeption of value for N and minimum bending radius;
tape type II, embossed carrier tape with top cover tape on the upper side;

max. pieces of filters per reel: 3000
reel of empty components at start: min. 300 mm
reel of empty components at start including leader: min. 500 mm
trailer: min. 300 mm

Tape (all dimensions in mm)

- W : 16,00 ± 0,3
- Po : 4,00 ± 0,1
- Do : 1,50 +0,1/-0
- E : 1,75 ± 0,1
- F : 7,50 ± 0,1
- G(min) : 0,60
- P2 : 2,00 ± 0,1
- P1 : 8,00 ± 0,1
- D1(min) : 1,50
- Ao : 5,50 ± 0,1
- Bo : 7,50 ± 0,1
- Ct : 13,5 ± 0,1

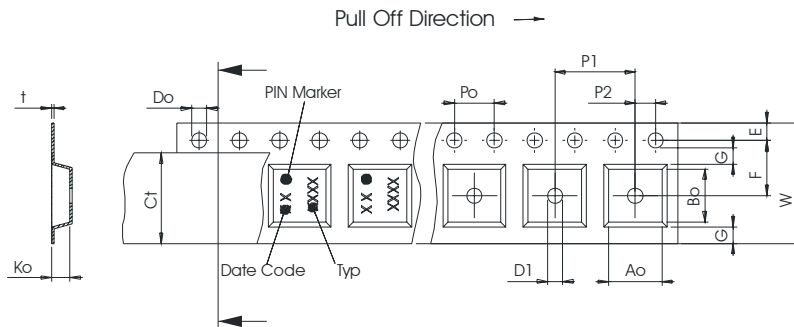

Reel (all dimensions in mm)

- A : 330
- W1 : 16,4 +2/-0
- W2(max) : 22,4
- N(min) : 50
- C : 13,0 +0,5/-0,2

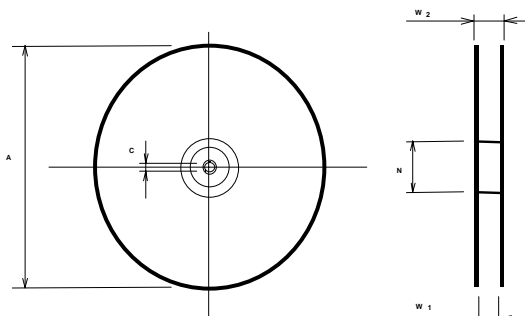

The minimum bending radius is 45 mm.

Tele Filter GmbH
Potsdamer Straße 18
D 14 513 TELTOW / Germany
Tel: (+49) 3328 4784-0 / Fax: (+49) 3328 4784-30
E-Mail: tft@telefilter.com

VI TELEFILTER reserves the right to make changes to the product(s) and/or information contained herein without notice. No liability is assumed as a result of their use or application. No rights under any patent accompany the sale of any such product(s) or information.

Air reflow temperature conditions

Conditions	Exposure
Average ramp-up rate (30°C to 217°C)	less than 3°C/second
> 100°C	between 300 and 600 seconds
> 150°C	between 240 and 500 seconds
> 217°C	between 30 and 150 seconds
Peak temperature	max. 260°C
Time within 5°C of actual peak temperature	between 10 and 30 seconds
Cool-down rate (Peak to 50°C)	less than 6°C/second
Time from 30°C to Peak temperature	no greater than 300 seconds

Chip-mount air reflow profile

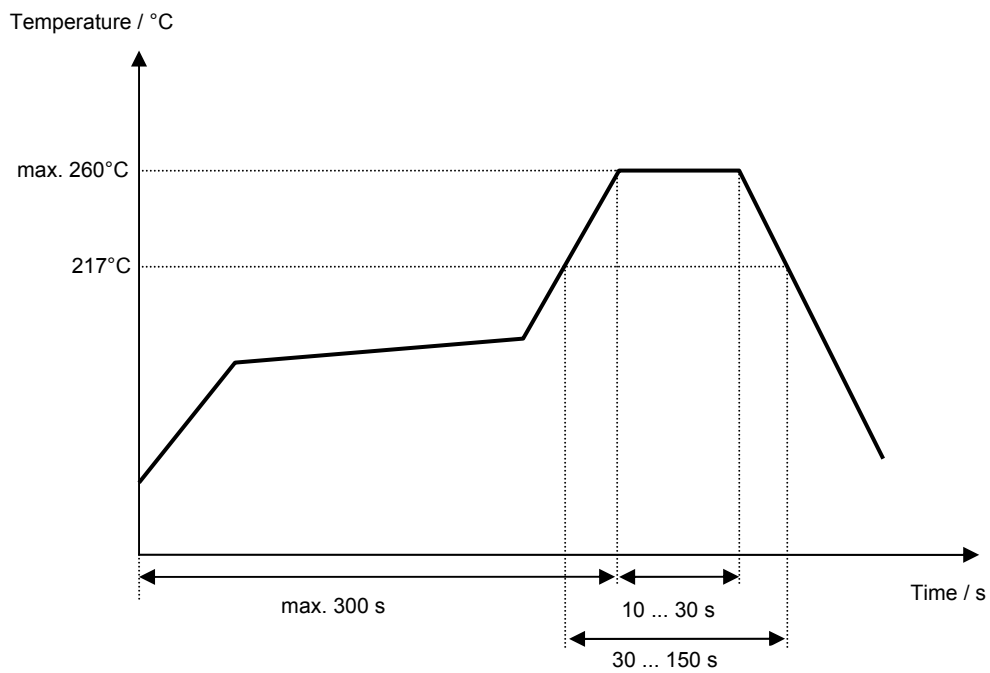

VI TELEFILTER**Filter specification****TFS 115D****5/5****History :**

Version	Reason of Changes	Name	Date
1.0	Generate development specification	Chilla	21.06.2005
1.1	Generate filter specification terminating impedances added typical values added filter characteristics added test circuit added ROHS compliance added	Chilla	03.02.2006