



BTA316 series B and C

16 A Three-quadrant triacs high commutation

Rev. 01 — 11 April 2007

Product data sheet

1. Product profile

1.1 General description

Passivated, new generation, high commutation triacs in a SOT78 plastic package

1.2 Features

- Very high commutation performance maximized at each gate sensitivity
- High immunity to dV/dt

1.3 Applications



- High power motor control - e.g. washing machines and vacuum cleaners
- Refrigeration and air conditioning compressors
- Non-linear rectifier-fed motor loads
- Electronic thermostats

1.4 Quick reference data

- $V_{DRM} \leq 600$ V (BTA316-600B/C)
- $V_{DRM} \leq 800$ V (BTA316-800B/C)
- $I_{TSM} \leq 140$ A ($t = 20$ ms)
- $I_{GT} \leq 50$ mA (BTA316 series B)
- $I_{GT} \leq 35$ mA (BTA316 series C)
- $I_{T(RMS)} \leq 16$ A

2. Pinning information

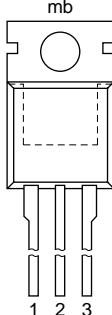
Table 1. Pinning

Pin	Description	Simplified outline	Symbol
1	main terminal 1 (T1)		 sym051
2	main terminal 2 (T2)		
3	gate (G)		
mb	mounting base; main terminal 2 (T2)		

3. Ordering information

Table 2. Ordering information

Type number	Package		Version
	Name	Description	
BTA316-600B	SC-46	plastic single-ended package; heatsink mounted; 1 mounting hole; 3-lead TO-220AB	SOT78
BTA316-600C			
BTA316-800B			
BTA316-800C			

4. Limiting values

Table 3. Limiting values

In accordance with the Absolute Maximum Rating System (IEC 60134).

Symbol	Parameter	Conditions	Min	Max	Unit
V_{DRM}	repetitive peak off-state voltage	BTA316-600B; BTA316-600C	[1]	600	V
		BTA316-800B; BTA316-800C	-	800	V
$I_{\text{T(RMS)}}$	RMS on-state current	full sine wave; $T_{\text{mb}} \leq 101$ °C; see Figure 4 and 5	-	16	A
I_{TSM}	non-repetitive peak on-state current	full sine wave; $T_{\text{j}} = 25$ °C prior to surge; see Figure 2 and 3			
		$t = 20$ ms	-	140	A
		$t = 16.7$ ms	-	150	A
I^2t	I^2t for fusing	$t = 10$ ms	-	98	A ² s
di_{T}/dt	rate of rise of on-state current	$I_{\text{TM}} = 20$ A; $I_{\text{G}} = 0.2$ A; $di_{\text{G}}/dt = 0.2$ A/ μ s	-	100	A/ μ s
I_{GM}	peak gate current		-	2	A
P_{GM}	peak gate power		-	5	W
$P_{\text{G(AV)}}$	average gate power	over any 20 ms period	-	0.5	W
T_{stg}	storage temperature		-40	+150	°C
T_{j}	junction temperature		-	125	°C

- [1] Although not recommended, off-state voltages up to 800 V may be applied without damage, but the triac may switch to the on-state. The rate of rise of current should not exceed 15 A/ μ s.

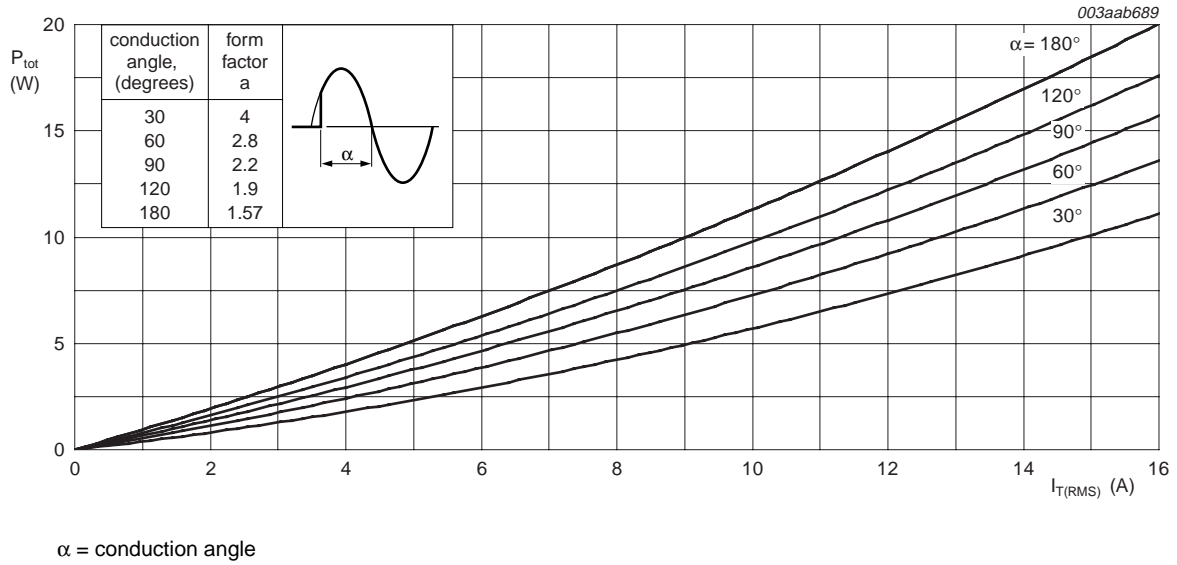

Fig 1. Total power dissipation as a function of RMS on-state current; maximum values

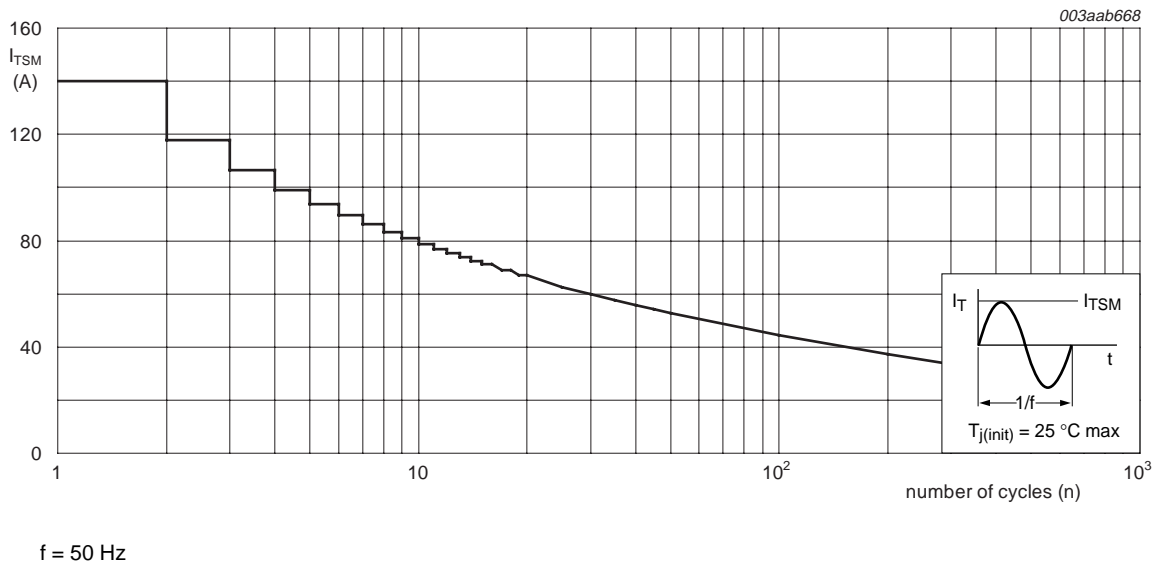
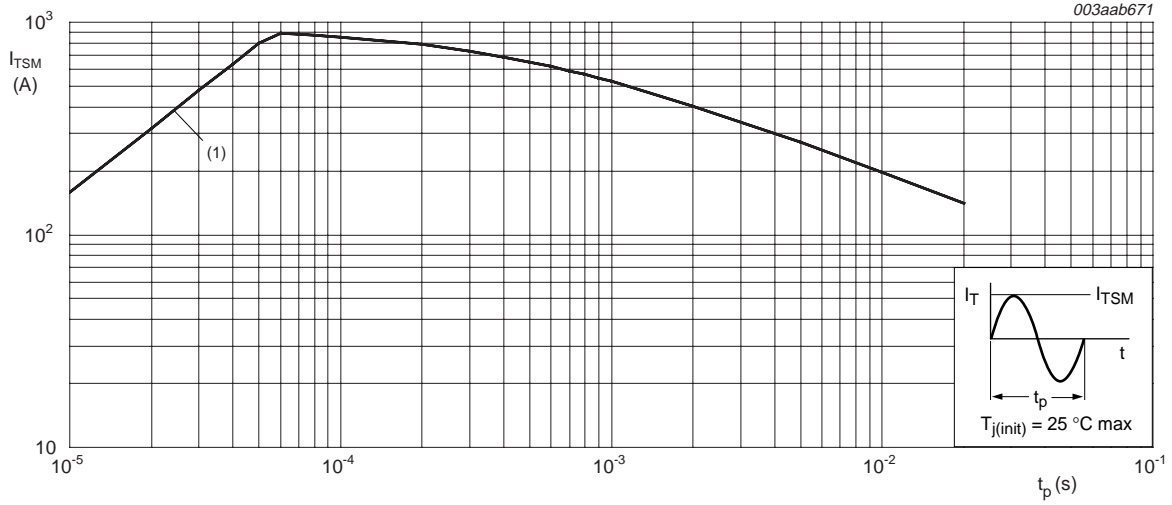
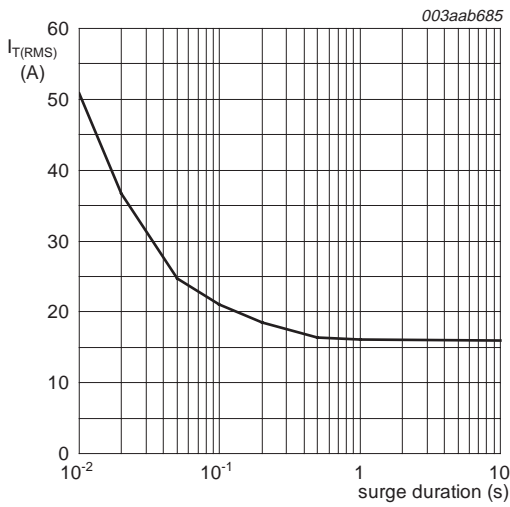

Fig 2. Non-repetitive peak on-state current as a function of the number of sinusoidal current cycles; maximum values



$t_p \leq 20 \text{ ms}$
 (1) di_T/dt limit

Fig 3. Non-repetitive peak on-state current as a function of pulse duration; maximum values



$f = 50 \text{ Hz}$;
 $T_{mb} = 101 \text{ °C}$

Fig 4. RMS on-state current as a function of surge duration; maximum values

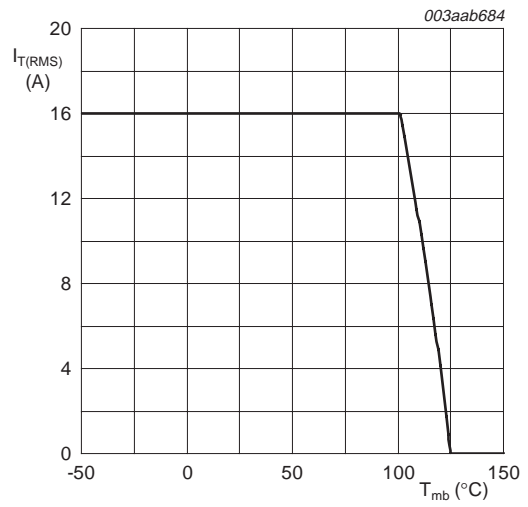
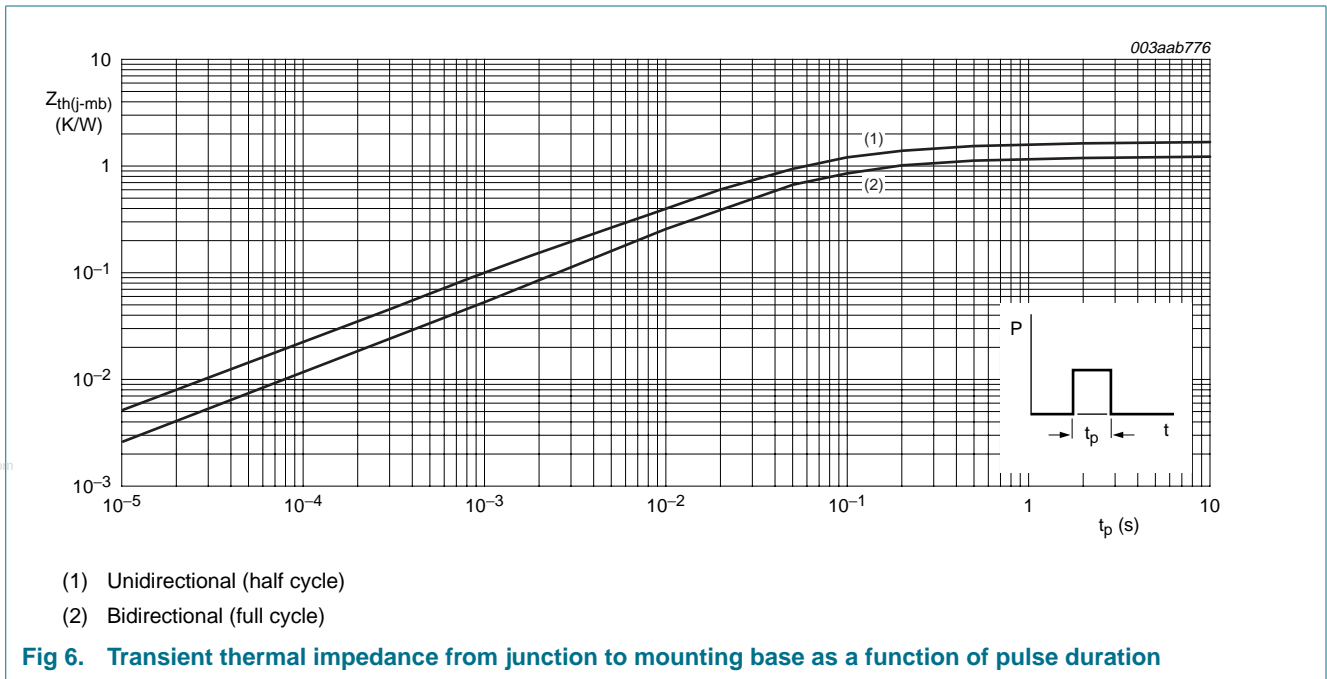

Fig 5. RMS on-state current as a function of mounting base temperature; maximum values

5. Thermal characteristics

Table 4. Thermal characteristics

Symbol	Parameter	Conditions	Min	Typ	Max	Unit
$R_{th(j-mb)}$	thermal resistance from junction to mounting base	half cycle; see Figure 6	-	-	1.7	K/W
		full cycle; see Figure 6	-	-	1.2	K/W
$R_{th(j-a)}$	thermal resistance from junction to ambient	in free air	-	60	-	K/W



6. Static characteristics

Table 5. Static characteristics
T_j = 25 °C unless otherwise specified.

Symbol	Parameter	Conditions	BTA316-600B BTA316-800B			BTA316-600C BTA316-800C			Unit
			Min	Typ	Max	Min	Typ	Max	
I _{GT}	gate trigger current	V _D = 12 V; I _T = 0.1 A; see Figure 8							
		T2+ G+	2	-	50	2	-	35	mA
		T2+ G-	2	-	50	2	-	35	mA
I _L	latching current	V _D = 12 V; I _{GT} = 0.1 A; see Figure 10							
		T2+ G+	-	-	60	-	-	50	mA
		T2+ G-	-	-	90	-	-	60	mA
I _H	holding current	V _D = 12 V; I _{GT} = 0.1 A; see Figure 11	-	-	60	-	-	35	mA
		T2- G-	2	-	50	2	-	35	mA
		T2- G-	-	-	60	-	-	50	mA
V _T	on-state voltage	I _T = 18 A; see Figure 9	-	1.3	1.5	-	1.3	1.5	V
V _{GT}	gate trigger voltage	V _D = 12 V; I _T = 0.1 A; see Figure 7	-	0.8	1.5	-	0.8	1.5	V
		V _D = 400 V; I _T = 0.1 A; T _j = 125 °C	0.25	0.4	-	0.25	0.4	-	V
I _D	off-state current	V _D = V _{DRM(max)} ; T _j = 125 °C	-	0.1	0.5	-	0.1	0.5	mA

7. Dynamic characteristics

Table 6. Dynamic characteristics

Symbol	Parameter	Conditions	BTA316-600B BTA316-800B			BTA316-600C BTA316-800C			Unit
			Min	Typ	Max	Min	Typ	Max	
dV_D/dt	rate of rise of off-state voltage	$V_{DM} = 0.67 \times V_{DRM(max)}$; $T_j = 125\text{ }^\circ\text{C}$; exponential waveform; gate open circuit	1000	-	-	500	-	-	V/ μs
di_{com}/dt	rate of change of commutating current	$V_{DM} = 400\text{ V}$; $T_j = 125\text{ }^\circ\text{C}$; $I_{T(RMS)} = 16\text{ A}$; without snubber; gate open circuit	20	-	-	15	-	-	A/ms
t_{gt}	gate-controlled turn-on time	$I_{TM} = 20\text{ A}$; $V_D = V_{DRM(max)}$; $I_G = 0.1\text{ A}$; $di_G/dt = 5\text{ A}/\mu\text{s}$	-	2	-	-	2	-	μs

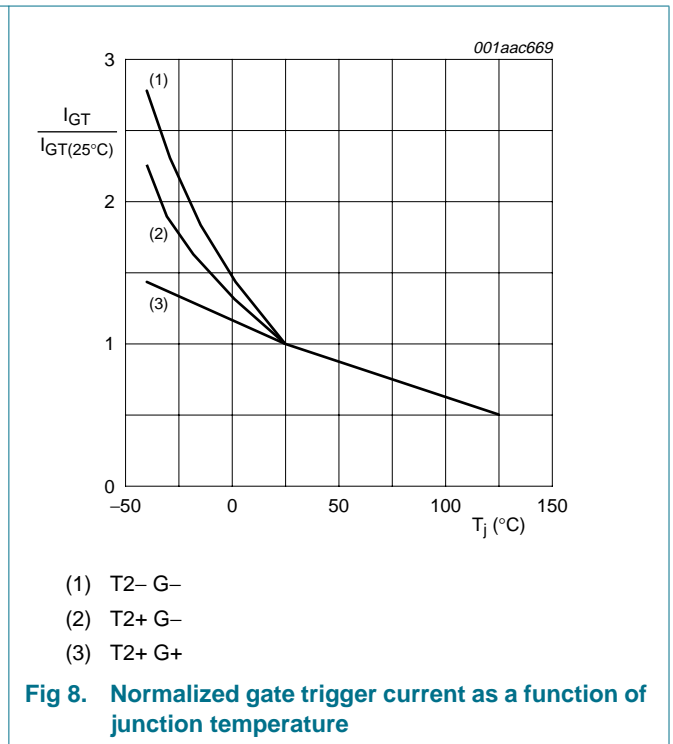
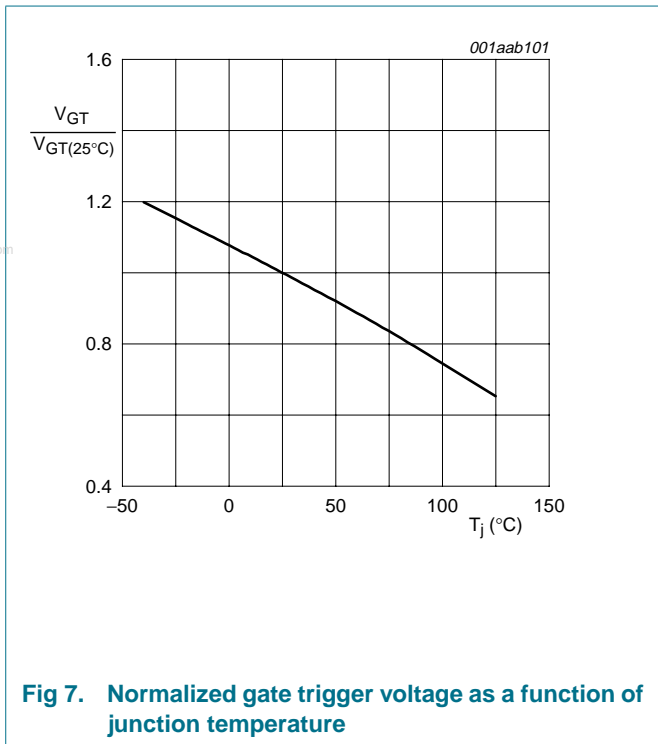

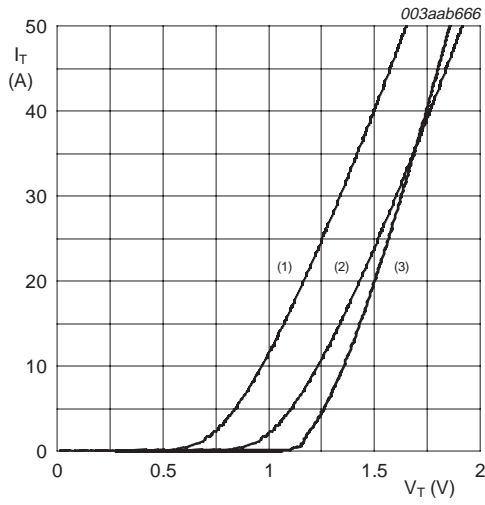

- $V_o = 1.024\text{ V}$
 $R_s = 0.021\ \Omega$
- (1) $T_j = 125\text{ }^\circ\text{C}$; typical values
 - (2) $T_j = 125\text{ }^\circ\text{C}$; maximum values
 - (3) $T_j = 25\text{ }^\circ\text{C}$; maximum values

Fig 9. On-state current as a function of on-state voltage

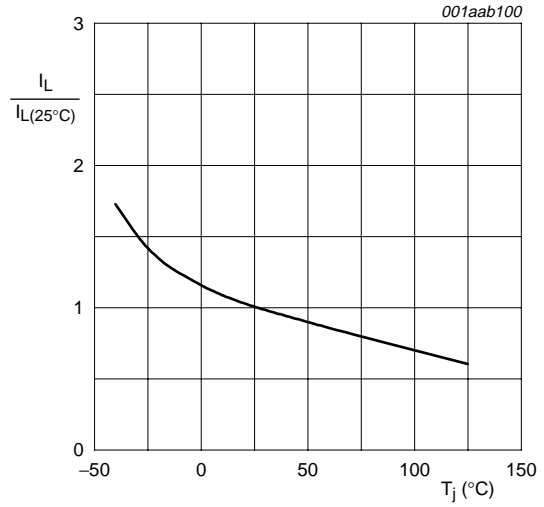

Fig 10. Normalized latching current as a function of junction temperature

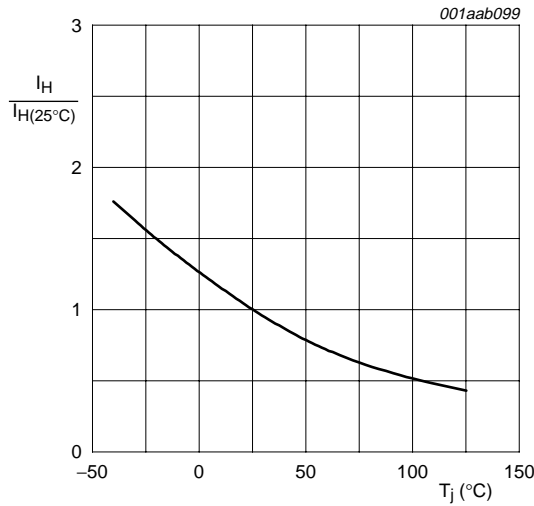

Fig 11. Normalized holding current as a function of junction temperature

8. Package outline

Plastic single-ended package; heatsink mounted; 1 mounting hole; 3-lead TO-220AB

SOT78

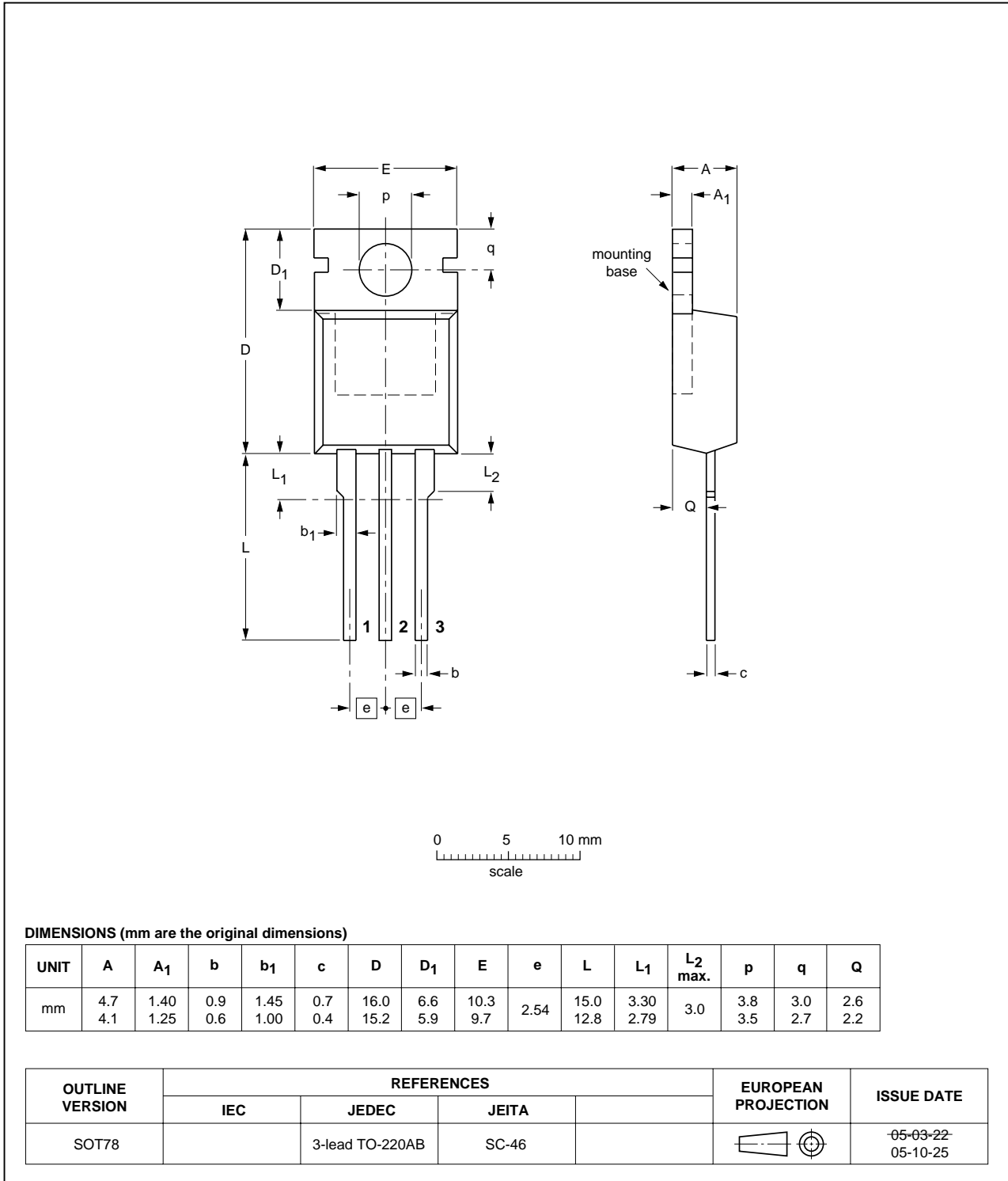

Fig 12. Package outline SOT78 (3-lead TO-220AB)

9. Revision history

Table 7. Revision history

Document ID	Release date	Data sheet status	Change notice	Supersedes
BTA316_SER_B_C_1	20070411	Product data sheet	-	-

10. Legal information

10.1 Data sheet status

Document status ^{[1][2]}	Product status ^[3]	Definition
Objective [short] data sheet	Development	This document contains data from the objective specification for product development.
Preliminary [short] data sheet	Qualification	This document contains data from the preliminary specification.
Product [short] data sheet	Production	This document contains the product specification.

[1] Please consult the most recently issued document before initiating or completing a design.

[2] The term 'short data sheet' is explained in section "Definitions".

[3] The product status of device(s) described in this document may have changed since this document was published and may differ in case of multiple devices. The latest product status information is available on the Internet at URL <http://www.nxp.com>.

10.2 Definitions

Draft — The document is a draft version only. The content is still under internal review and subject to formal approval, which may result in modifications or additions. NXP Semiconductors does not give any representations or warranties as to the accuracy or completeness of information included herein and shall have no liability for the consequences of use of such information.

Short data sheet — A short data sheet is an extract from a full data sheet with the same product type number(s) and title. A short data sheet is intended for quick reference only and should not be relied upon to contain detailed and full information. For detailed and full information see the relevant full data sheet, which is available on request via the local NXP Semiconductors sales office. In case of any inconsistency or conflict with the short data sheet, the full data sheet shall prevail.

10.3 Disclaimers

Right to make changes — NXP Semiconductors reserves the right to make changes to information published in this document, including without limitation specifications and product descriptions, at any time and without notice. This document supersedes and replaces all information supplied prior to the publication hereof.

General — Information in this document is believed to be accurate and reliable. However, NXP Semiconductors does not give any representations or warranties, expressed or implied, as to the accuracy or completeness of such information and shall have no liability for the consequences of use of such information.

Suitability for use — NXP Semiconductors products are not designed, authorized or warranted to be suitable for use in medical, military, aircraft, space or life support equipment, nor in applications where failure or

malfunction of a NXP Semiconductors product can reasonably be expected to result in personal injury, death or severe property or environmental damage. NXP Semiconductors accepts no liability for inclusion and/or use of NXP Semiconductors products in such equipment or applications and therefore such inclusion and/or use is at the customer's own risk.

Applications — Applications that are described herein for any of these products are for illustrative purposes only. NXP Semiconductors makes no representation or warranty that such applications will be suitable for the specified use without further testing or modification.

Limiting values — Stress above one or more limiting values (as defined in the Absolute Maximum Ratings System of IEC 60134) may cause permanent damage to the device. Limiting values are stress ratings only and operation of the device at these or any other conditions above those given in the Characteristics sections of this document is not implied. Exposure to limiting values for extended periods may affect device reliability.

Terms and conditions of sale — NXP Semiconductors products are sold subject to the general terms and conditions of commercial sale, as published at <http://www.nxp.com/profile/terms>, including those pertaining to warranty, intellectual property rights infringement and limitation of liability, unless explicitly otherwise agreed to in writing by NXP Semiconductors. In case of any inconsistency or conflict between information in this document and such terms and conditions, the latter will prevail.

No offer to sell or license — Nothing in this document may be interpreted or construed as an offer to sell products that is open for acceptance or the grant, conveyance or implication of any license under any copyrights, patents or other industrial or intellectual property rights.

10.4 Trademarks

Notice: All referenced brands, product names, service names and trademarks are the property of their respective owners.

11. Contact information

For additional information, please visit: <http://www.nxp.com>

For sales office addresses, send an email to: salesaddresses@nxp.com

12. Contents

1 Product profile 1

1.1 General description 1

1.2 Features 1

1.3 Applications 1

1.4 Quick reference data 1

2 Pinning information 1

3 Ordering information 2

4 Limiting values 2

5 Thermal characteristics 5

6 Static characteristics 6

7 Dynamic characteristics 7

8 Package outline 9

9 Revision history 10

10 Legal information 11

10.1 Data sheet status 11

10.2 Definitions 11

10.3 Disclaimers 11

10.4 Trademarks 11

11 Contact information 11

12 Contents 12

www.DataSheet4U.com

Please be aware that important notices concerning this document and the product(s) described herein, have been included in section 'Legal information'.



© NXP B.V. 2007. **All rights reserved.**
 For more information, please visit: <http://www.nxp.com>
 For sales office addresses, please send an email to: salesaddresses@nxp.com
 Date of release: 11 April 2007
 Document identifier: BTA316_SER_B_C_1