

TOSHIBA Power MOS FET Module Silicon N Channel MOS Type (L²-π-MOSV 4 in 1)

MP4411

High Power, High Speed Switching Applications
 For Printer Head Pin Driver and Pulse Motor Driver
 For Solenoid Driver

- 4 V gate drive available
- Small package by full molding (SIP 12 pin)
- High drain power dissipation (4 devices operation)
 : P_T = 28 W (T_c = 25°C)
- Low drain-source ON resistance: R_{DS (ON)} = 0.28 Ω (typ.)
- High forward transfer admittance: |Y_{fs}| = 3.5 S (typ.)
- Low leakage current: I_{GSS} = ±10 μA (max) (V_{GS} = ±16 V)
 I_{DSS} = 100 μA (max) (V_{DS} = 100 V)
- Enhancement-mode: V_{th} = 0.8 to 2.0 V (V_{DS} = 10 V, I_D = 1 mA)

Maximum Ratings (Ta = 25°C)

Characteristics		Symbol	Rating	Unit
Drain-source voltage		V _{DSS}	100	V
Drain-gate voltage (R _{GS} = 20 kΩ)		V _{DGR}	100	V
Gate-source voltage		V _{GSS}	±20	V
Drain current	DC	I _D	3	A
	Pulse	I _{DP}	12	
Drain power dissipation (1 device operation, Ta = 25°C)		P _D	2.2	W
Drain power dissipation (4 devices operation)	Ta = 25°C	P _{DT}	4.4	W
	Tc = 25°C		28	
Single pulse avalanche energy (Note 1)		E _{AS}	140	mJ
Avalanche current		I _{AR}	3	A
Repetitive avalanche energy (Note 2)	1 device operation	E _{AR}	0.22	mJ
	4 devices operation	E _{ART}	0.44	
Channel temperature		T _{ch}	150	°C
Storage temperature range		T _{stg}	-55 to 150	°C

Note 1: Avalanche energy (single pulse) applied condition

$$V_{DD} = 50 \text{ V, starting } T_{ch} = 25^\circ\text{C, } L = 20 \text{ mH, } R_G = 25 \Omega, I_{AR} = 3 \text{ A}$$

Note 2: Repetitive rating; pulse width limited by maximum channel temperature.

This transistor is an electrostatic sensitive device. Please handle with caution.

Industrial Applications

Unit: mm

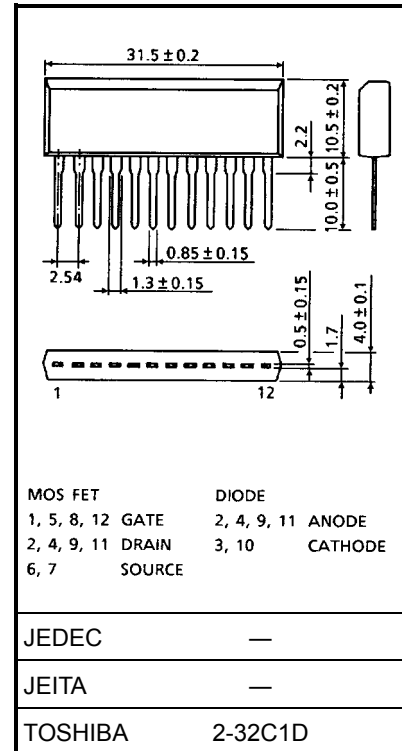

Weight: 3.9 g (typ.)

Array Configuration

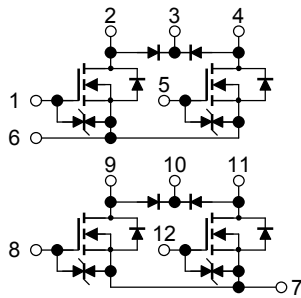

Thermal Characteristics

Characteristics	Symbol	Max	Unit
Thermal resistance of channel to ambient (4 devices operation, $T_a = 25^\circ\text{C}$)	$\Sigma R_{\text{th (ch-a)}}$	28.4	$^\circ\text{C/W}$
Thermal resistance of channel to case (4 devices operation, $T_c = 25^\circ\text{C}$)	$\Sigma R_{\text{th (ch-c)}}$	4.46	$^\circ\text{C/W}$
Maximum lead temperature for soldering purposes (3.2 mm from case for $t = 10$ s)	T_L	260	$^\circ\text{C}$

Electrical Characteristics ($T_a = 25^\circ\text{C}$)

Characteristics		Symbol	Test Condition	Min	Typ.	Max	Unit
Gate leakage current		I_{GSS}	$V_{\text{GS}} = \pm 16 \text{ V}, V_{\text{DS}} = 0 \text{ V}$	—	—	± 10	μA
Drain cut-off current		I_{DSS}	$V_{\text{DS}} = 100 \text{ V}, V_{\text{GS}} = 0 \text{ V}$	—	—	100	μA
Drain-source breakdown voltage		$V_{(\text{BR})\text{DSS}}$	$I_{\text{D}} = 10 \text{ mA}, V_{\text{GS}} = 0 \text{ V}$	100	—	—	V
Gate threshold voltage		V_{th}	$V_{\text{DS}} = 10 \text{ V}, I_{\text{D}} = 1 \text{ mA}$	0.8	—	2.0	V
Drain-source ON resistance		$R_{\text{DS (ON)}}$	$V_{\text{GS}} = 4 \text{ V}, I_{\text{D}} = 2 \text{ A}$	—	0.36	0.45	Ω
			$V_{\text{GS}} = 10 \text{ V}, I_{\text{D}} = 2 \text{ A}$	—	0.28	0.35	
Forward transfer admittance		$ Y_{\text{fs}} $	$V_{\text{DS}} = 10 \text{ V}, I_{\text{D}} = 2 \text{ A}$	1.5	3.5	—	S
Input capacitance		C_{iSS}	$V_{\text{DS}} = 10 \text{ V}, V_{\text{GS}} = 0 \text{ V}, f = 1 \text{ MHz}$	—	280	—	pF
Reverse transfer capacitance		C_{rSS}		—	50	—	pF
Output capacitance		C_{oSS}		—	105	—	pF
Switching time	Rise time	t_r		—	20	—	ns
	Turn-on time	t_{on}		—	50	—	
	Fall time	t_f		—	40	—	
	Turn-off time	t_{off}		—	170	—	
Total gate charge (gate-source plus gate-drain)		Q_g	$V_{\text{DD}} \approx 80 \text{ V}, V_{\text{GS}} = 10 \text{ V}, I_{\text{D}} = 3 \text{ A}$	—	13.5	—	nC
Gate-source charge		Q_{gs}		—	8.5	—	nC
Gate-drain ("miller") charge		Q_{gd}		—	5	—	nC

Source-Drain Diode Ratings and Characteristics (Ta = 25°C)

Characteristics	Symbol	Test Condition	Min	Typ.	Max	Unit
Continuous drain reverse current	I_{DR}	—	—	—	3	A
Pulse drain reverse current	I_{DRP}	—	—	—	12	A
Diode forward voltage	V_{DSF}	$I_{DR} = 3\text{ A}, V_{GS} = 0\text{ V}$	—	—	-1.5	V
Reverse recovery time	t_{rr}	$I_{DR} = 3\text{ A}, V_{GS} = 0\text{ V},$ $dI_{DR}/dt = 50\text{ A}/\mu\text{s}$	—	100	—	ns
Reverse recovery charge	Q_{rr}		—	0.2	—	μC

Flyback-Diode Rating and Characteristics (Ta = 25°C)

Characteristics	Symbol	Test Condition	Min	Typ.	Max	Unit
Forward current	I_{FM}	—	—	—	3	A
Reverse current	I_R	$V_R = 100\text{ V}$	—	—	0.4	μA
Reverse voltage	V_R	$I_R = 100\text{ }\mu\text{A}$	100	—	—	V
Forward voltage	V_F	$I_F = 0.5\text{ A}$	—	—	1.8	V

Marking

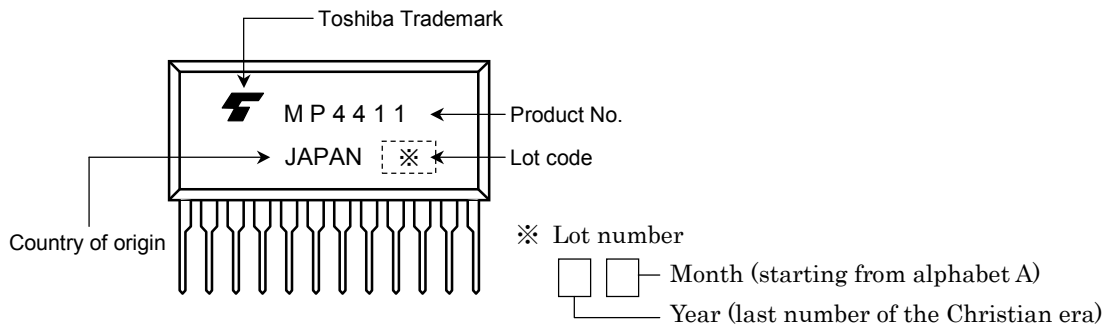

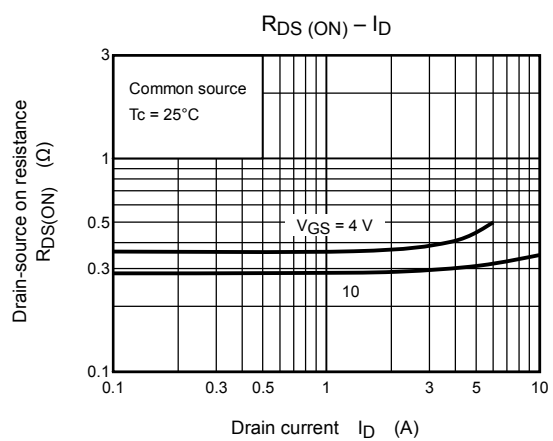
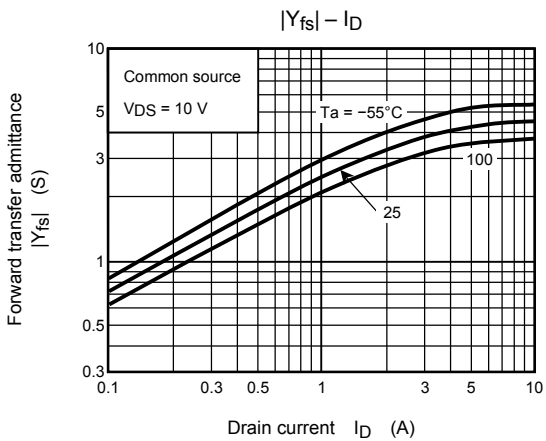
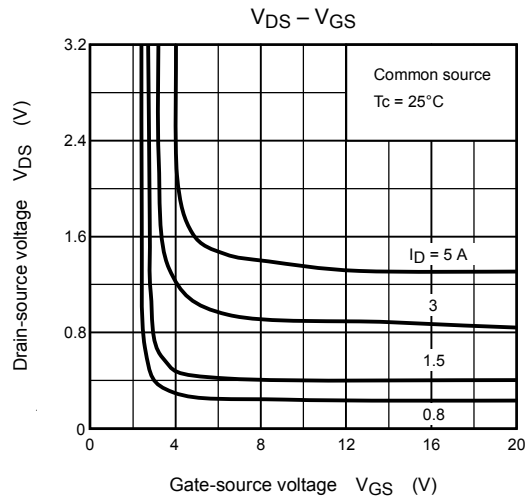
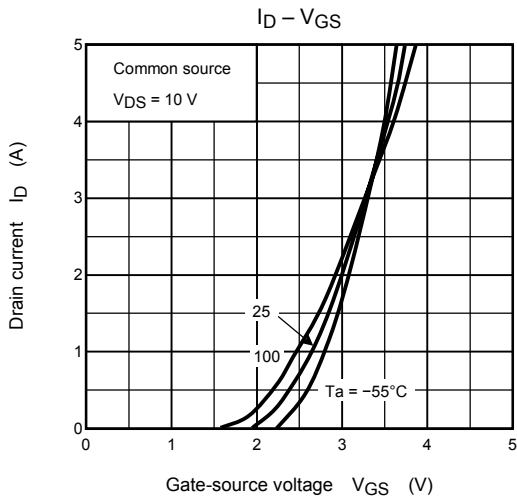
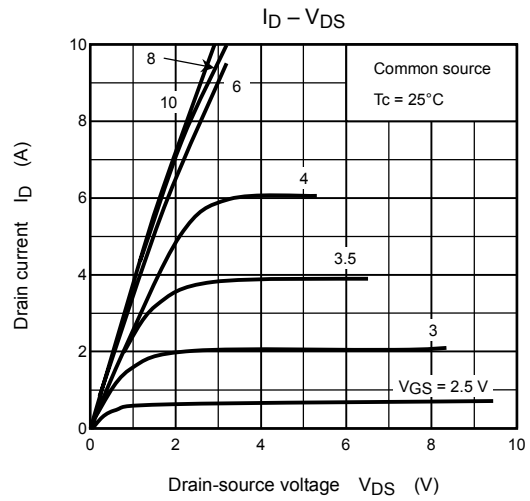
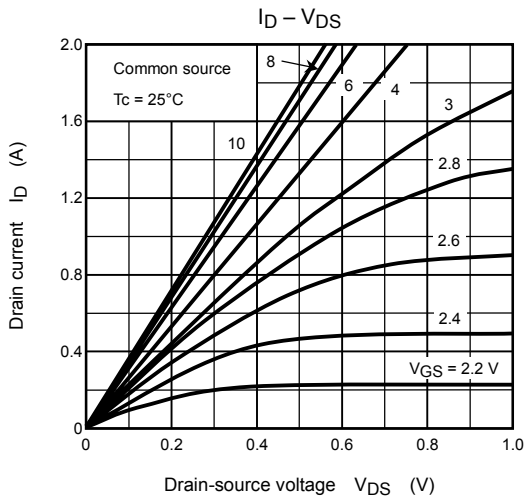

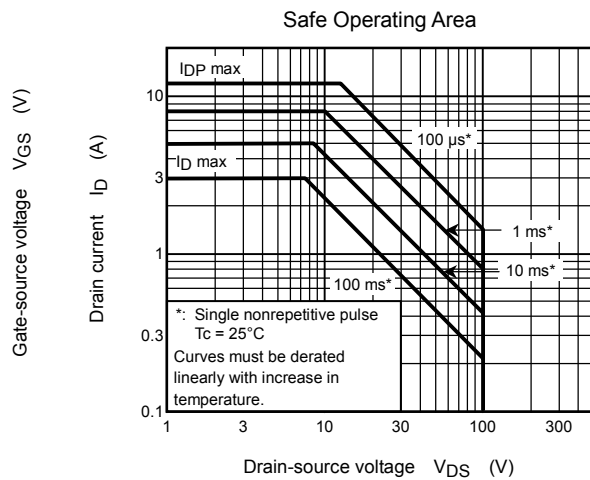
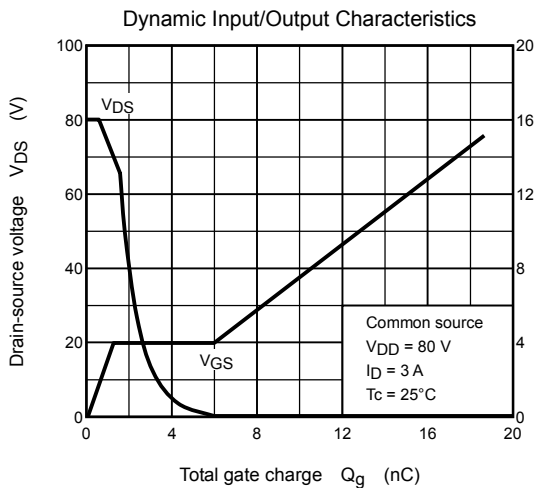
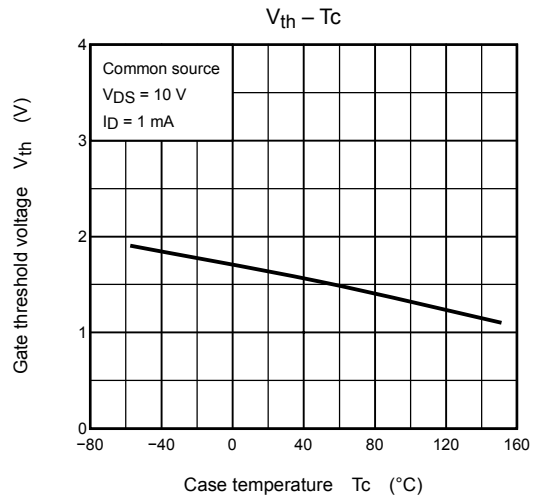
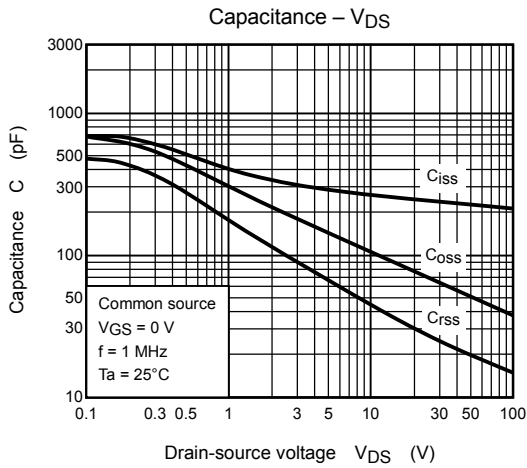
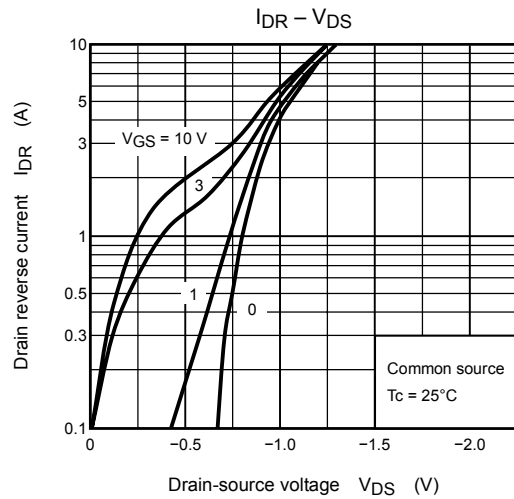
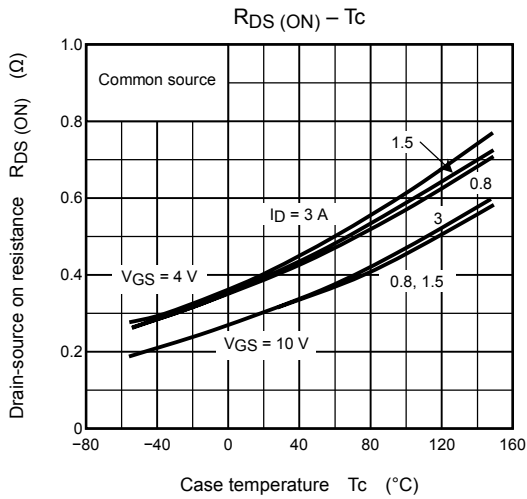

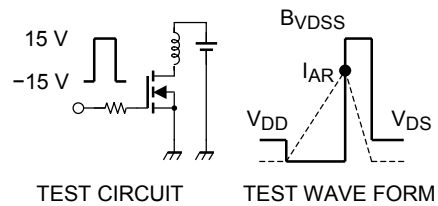
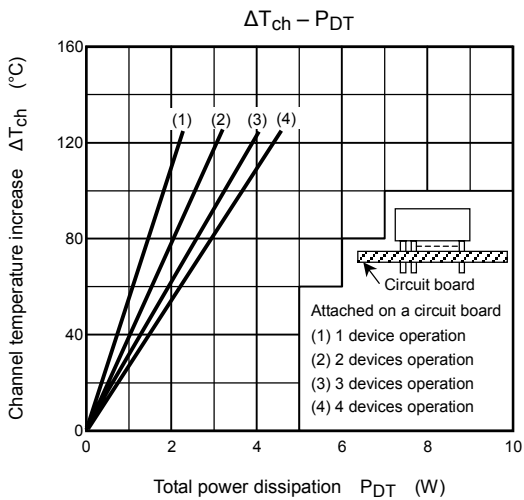
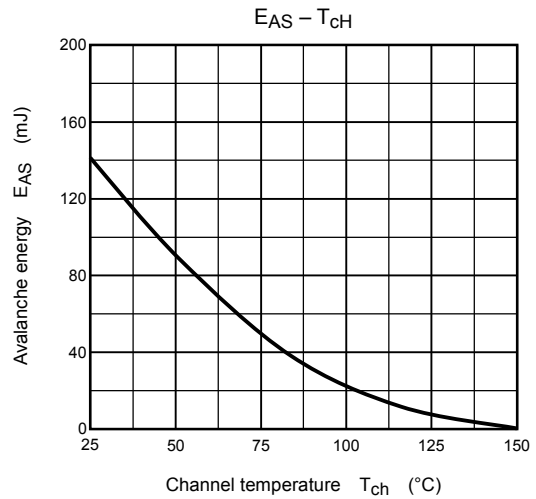
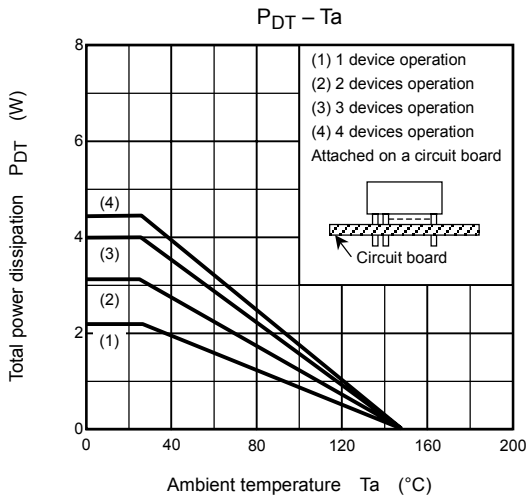
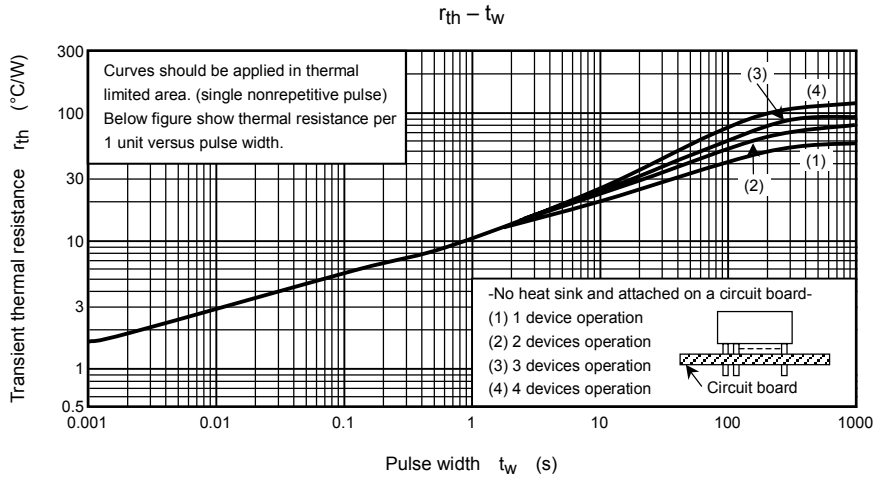

Peak $I_{AR} = 3 \text{ A}$, $R_G = 25 \Omega$
 $V_{DD} = 50 \text{ V}$, $L = 20 \text{ mH}$

$$E_{AS} = \frac{1}{2} \cdot L \cdot I^2 \cdot \left(\frac{BV_{DSS}}{BV_{DSS} - V_{DD}} \right)$$

RESTRICTIONS ON PRODUCT USE

000707EAA

- TOSHIBA is continually working to improve the quality and reliability of its products. Nevertheless, semiconductor devices in general can malfunction or fail due to their inherent electrical sensitivity and vulnerability to physical stress. It is the responsibility of the buyer, when utilizing TOSHIBA products, to comply with the standards of safety in making a safe design for the entire system, and to avoid situations in which a malfunction or failure of such TOSHIBA products could cause loss of human life, bodily injury or damage to property.
In developing your designs, please ensure that TOSHIBA products are used within specified operating ranges as set forth in the most recent TOSHIBA products specifications. Also, please keep in mind the precautions and conditions set forth in the "Handling Guide for Semiconductor Devices," or "TOSHIBA Semiconductor Reliability Handbook" etc..
- The TOSHIBA products listed in this document are intended for usage in general electronics applications (computer, personal equipment, office equipment, measuring equipment, industrial robotics, domestic appliances, etc.). These TOSHIBA products are neither intended nor warranted for usage in equipment that requires extraordinarily high quality and/or reliability or a malfunction or failure of which may cause loss of human life or bodily injury ("Unintended Usage"). Unintended Usage include atomic energy control instruments, airplane or spaceship instruments, transportation instruments, traffic signal instruments, combustion control instruments, medical instruments, all types of safety devices, etc.. Unintended Usage of TOSHIBA products listed in this document shall be made at the customer's own risk.
- The information contained herein is presented only as a guide for the applications of our products. No responsibility is assumed by TOSHIBA CORPORATION for any infringements of intellectual property or other rights of the third parties which may result from its use. No license is granted by implication or otherwise under any intellectual property or other rights of TOSHIBA CORPORATION or others.
- The information contained herein is subject to change without notice.