

FEATURES

- **Gain-Bandwidth Product: 30MHz**
- **Slew Rate: 10V/ μ s**
- **Low Supply Current per Amplifier: 3.5mA**
- Input Common Mode Range Includes Both Rails
- Output Swings Rail-to-Rail
- Input Offset Voltage, Rail-to-Rail: 525 μ V Max
- Input Offset Current: 150nA Max
- Input Bias Current: 1000nA Max
- Open-Loop Gain: 1000V/mV Min
- Low Input Noise Voltage: 6nV/ $\sqrt{\text{Hz}}$ Typ
- Low Distortion: -91dBc at 100kHz
- Wide Supply Range: 2.7V to \pm 15V
- Large Output Drive Current: 35mA Min
- Dual in 8-Pin PDIP and SO Packages
- Quad in Narrow 14-Pin SO Package

APPLICATIONS

- Active Filters
- Rail-to-Rail Buffer Amplifiers
- Driving A/D Converters
- Low Voltage Signal Processing
- Battery-Powered Systems

 LTC and LT are registered trademarks of Linear Technology Corporation.

DESCRIPTION

The LT[®]1630/LT1631 are dual/quad, rail-to-rail input and output op amps with a 30MHz gain-bandwidth product and a 10V/ μ s slew rate.

The LT1630/LT1631 have excellent DC precision over the full range of operation. Input offset voltage is typically less than 150 μ V and the minimum open-loop gain of one million into a 10k load virtually eliminates all gain error. To maximize common mode rejection, the LT1630/LT1631 employ a patented trim technique for both input stages, one at the negative supply and the other at the positive supply, that gives a typical CMRR of 106dB over the full input range.

The LT1630/LT1631 maintain their performance for supplies from 2.7V to 36V and are specified at 3V, 5V and \pm 15V supplies. The inputs can be driven beyond the supplies without damage or phase reversal of the output. The output delivers load currents in excess of 35mA.

The LT1630 is available in 8-pin PDIP and SO packages with the standard dual op amp pinout. The LT1631 features the standard quad op amp configuration and is available in a 14-pin plastic SO package. These devices can be used as plug-in replacements for many standard op amps to improve input/output range and performance.

TYPICAL APPLICATION

Single Supply, 400kHz, 4th Order Butterworth Filter

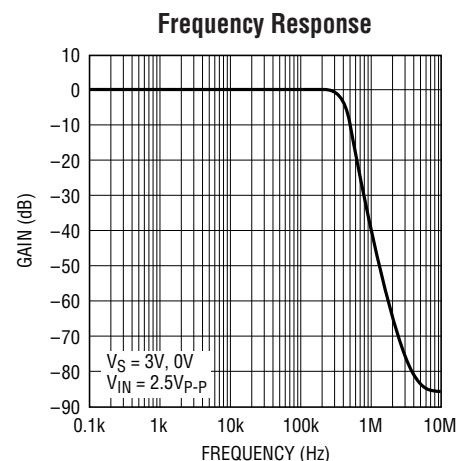
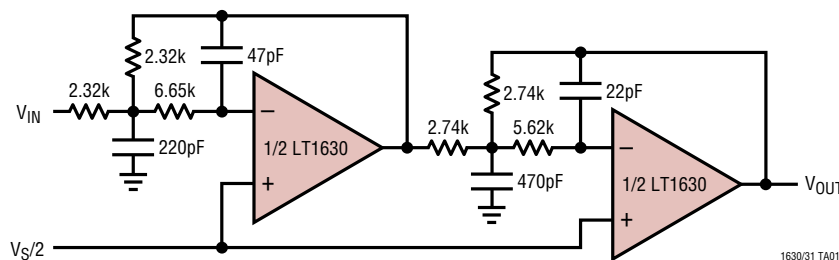

1630/31 TA02

sn16301 16301fs

LT1630/LT1631

ABSOLUTE MAXIMUM RATINGS (Note 1)

Total Supply Voltage (V^+ to V^-)	36V	Specified Temperature Range (Note 4) ...	-40°C to 85°C
Input Current	$\pm 10\text{mA}$	Junction Temperature	150°C
Output Short-Circuit Duration (Note 2)	Continuous	Storage Temperature Range	-65°C to 150°C
Operating Temperature Range	-40°C to 85°C	Lead Temperature (Soldering, 10 sec)	300°C

PACKAGE/ORDER INFORMATION

<p>N8 PACKAGE 8-LEAD PDIP</p> <p>S8 PACKAGE 8-LEAD PLASTIC SO</p> <p>$T_{JMAX} = 150^{\circ}\text{C}$, $\theta_{JA} = 130^{\circ}\text{C/W}$ (N8) $T_{JMAX} = 150^{\circ}\text{C}$, $\theta_{JA} = 190^{\circ}\text{C/W}$ (S8)</p>	ORDER PART NUMBER	<p>S PACKAGE 14-LEAD PLASTIC SO</p> <p>$T_{JMAX} = 150^{\circ}\text{C}$, $\theta_{JA} = 150^{\circ}\text{C/W}$</p>	ORDER PART NUMBER
	LT1630CN8 LT1630CS8 LT1630IN8 LT1630IS8		S8 PART MARKING
	1630 1630I		

Consult factory for Military and Industrial grade parts.

ELECTRICAL CHARACTERISTICS

$T_A = 25^{\circ}\text{C}$, $V_S = 5\text{V}$, 0V ; $V_S = 3\text{V}$, 0V ; $V_{CM} = V_{OUT} = \text{half supply}$, unless otherwise noted.

SYMBOL	PARAMETER	CONDITIONS	MIN	TYP	MAX	UNITS
V_{OS}	Input Offset Voltage	$V_{CM} = V^+$		150	525	μV
		$V_{CM} = V^-$		150	525	μV
ΔV_{OS}	Input Offset Shift	$V_{CM} = V^-$ to V^+		150	525	μV
		Input Offset Voltage Match (Channel-to-Channel)	$V_{CM} = V^-, V^+$ (Note 5)	200	950	μV
I_B	Input Bias Current	$V_{CM} = V^+$	0	540	1000	nA
		$V_{CM} = V^-$	-1000	-540	0	nA
ΔI_B	Input Bias Current Shift	$V_{CM} = V^-$ to V^+		1080	2000	nA
		Input Bias Current Match (Channel-to-Channel)	$V_{CM} = V^+$ (Note 5) $V_{CM} = V^-$ (Note 5)	25	300	nA
I_{OS}	Input Offset Current	$V_{CM} = V^+$		20	150	nA
		$V_{CM} = V^-$		20	150	nA
ΔI_{OS}	Input Offset Current Shift	$V_{CM} = V^-$ to V^+		40	300	nA
		Input Noise Voltage	0.1Hz to 10Hz		300	nV _{p-p}
e_n	Input Noise Voltage Density	$f = 1\text{kHz}$		6	nV/ $\sqrt{\text{Hz}}$	
i_n	Input Noise Current Density	$f = 1\text{kHz}$		0.9	pA/ $\sqrt{\text{Hz}}$	
C_{IN}	Input Capacitance			5	pF	
A_{VOL}	Large-Signal Voltage Gain	$V_S = 5\text{V}$, $V_O = 300\text{mV}$ to 4.7V , $R_L = 10\text{k}$	500	3500		V/mV
		$V_S = 3\text{V}$, $V_O = 300\text{mV}$ to 2.7V , $R_L = 10\text{k}$	400	2000		V/mV

sn16301 16301fs

ELECTRICAL CHARACTERISTICS

$T_A = 25^\circ\text{C}$, $V_S = 5\text{V}, 0\text{V}$; $V_S = 3\text{V}, 0\text{V}$; $V_{CM} = V_{OUT} = \text{half supply}$, unless otherwise noted.

SYMBOL	PARAMETER	CONDITIONS	MIN	TYP	MAX	UNITS
CMRR	Common Mode Rejection Ratio	$V_S = 5\text{V}, V_{CM} = V^- \text{ to } V^+$	79	90		dB
		$V_S = 3\text{V}, V_{CM} = V^- \text{ to } V^+$	75	86		dB
	CMRR Match (Channel-to-Channel) (Note 5)	$V_S = 5\text{V}, V_{CM} = V^- \text{ to } V^+$	72	96		dB
		$V_S = 3\text{V}, V_{CM} = V^- \text{ to } V^+$	67	88		dB
PSRR	Power Supply Rejection Ratio	$V_S = 2.7\text{V to } 12\text{V}, V_{CM} = V_O = 0.5\text{V}$	87	105		dB
		PSRR Match (Channel-to-Channel) (Note 5)	80	107		dB
	Minimum Supply Voltage (Note 9)	$V_{CM} = V_O = 0.5\text{V}$		2.6	2.7	V
V_{OL}	Output Voltage Swing Low (Note 6)	No Load		14	30	mV
		$I_{SINK} = 0.5\text{mA}$		31	60	mV
		$I_{SINK} = 25\text{mA}, V_S = 5\text{V}$		600	1200	mV
		$I_{SINK} = 20\text{mA}, V_S = 3\text{V}$		500	1000	mV
V_{OH}	Output Voltage Swing High (Note 6)	No Load		15	40	mV
		$I_{SOURCE} = 0.5\text{mA}$		42	80	mV
		$I_{SOURCE} = 20\text{mA}, V_S = 5\text{V}$		900	1800	mV
		$I_{SOURCE} = 15\text{mA}, V_S = 3\text{V}$		680	1400	mV
I_{SC}	Short-Circuit Current	$V_S = 5\text{V}$	± 20	± 41		mA
		$V_S = 3\text{V}$	± 15	± 30		mA
I_S	Supply Current per Amplifier			3.5	4.4	mA
GBW	Gain-Bandwidth Product (Note 7)	$f = 100\text{kHz}$	15	30		MHz
SR	Slew Rate (Note 8)	$V_S = 5\text{V}, A_V = -1, R_L = \text{Open}, V_O = 4\text{V}$	4.6	9.2		V/ μs
		$V_S = 3\text{V}, A_V = -1, R_L = \text{Open}$	4.2	8.5		V/ μs
t_S	Settling Time	$V_S = 5\text{V}, A_V = 1, R_L = 1\text{k}, 0.01\%, V_{STEP} = 2\text{V}$		520		ns

$0^\circ\text{C} < T_A < 70^\circ\text{C}$, $V_S = 5\text{V}, 0\text{V}$; $V_S = 3\text{V}, 0\text{V}$; $V_{CM} = V_{OUT} = \text{half supply}$, unless otherwise noted.

SYMBOL	PARAMETER	CONDITIONS	MIN	TYP	MAX	UNITS
V_{OS}	Input Offset Voltage	$V_{CM} = V^+ - 0.1\text{V}$	●	175	700	μV
		$V_{CM} = V^- + 0.2\text{V}$	●	175	700	μV
$V_{OS\ TC}$	Input Offset Voltage Drift (Note 3)	$V_{CM} = V^+ - 0.1\text{V}$	●	2.5	5.5	$\mu\text{V}/^\circ\text{C}$
		$V_{CM} = V^- + 0.2\text{V}$	●	1	3.5	$\mu\text{V}/^\circ\text{C}$
ΔV_{OS}	Input Offset Voltage Shift	$V_{CM} = V^- + 0.2\text{V to } V^+ - 0.1\text{V}$	●	175	750	μV
		Input Offset Voltage Match (Channel-to-Channel)	$V_{CM} = V^- + 0.2\text{V}, V^+ - 0.1\text{V}$ (Note 5)	●	200	1200
I_B	Input Bias Current	$V_{CM} = V^+ - 0.1\text{V}$	●	0	585	nA
		$V_{CM} = V^- + 0.2\text{V}$	●	-1100	-585	0
ΔI_B	Input Bias Current Shift	$V_{CM} = V^- + 0.2\text{V to } V^+ - 0.1\text{V}$	●	1170	2200	nA
		Input Bias Current Match (Channel-to-Channel)	$V_{CM} = V^+ - 0.1\text{V}$ (Note 5)	●	25	340
		$V_{CM} = V^- + 0.2\text{V}$ (Note 5)	●	25	340	nA
I_{OS}	Input Offset Current	$V_{CM} = V^+ - 0.1\text{V}$	●	20	170	nA
		$V_{CM} = V^- + 0.2\text{V}$	●	20	170	nA
ΔI_{OS}	Input Offset Current Shift	$V_{CM} = V^- + 0.2\text{V to } V^+ - 0.1\text{V}$	●	40	340	nA
A_{VOL}	Large-Signal Voltage Gain	$V_S = 5\text{V}, V_O = 300\text{mV to } 4.7\text{V}, R_L = 10\text{k}$	●	450	3500	V/mV
		$V_S = 3\text{V}, V_O = 300\text{mV to } 2.7\text{V}, R_L = 10\text{k}$	●	350	2000	V/mV
CMRR	Common Mode Rejection Ratio	$V_S = 5\text{V}, V_{CM} = V^- + 0.2\text{V to } V^+ - 0.1\text{V}$	●	75	89	dB
		$V_S = 3\text{V}, V_{CM} = V^- + 0.2\text{V to } V^+ - 0.1\text{V}$	●	71	83	dB
	CMRR Match (Channel-to-Channel) (Note 5)	$V_S = 5\text{V}, V_{CM} = V^- + 0.2\text{V to } V^+ - 0.1\text{V}$	●	70	90	dB
		$V_S = 3\text{V}, V_{CM} = V^- + 0.2\text{V to } V^+ - 0.1\text{V}$	●	65	85	dB

sn16301 16301fs

ELECTRICAL CHARACTERISTICS

0°C < T_A < 70°C, V_S = 5V, 0V; V_S = 3V, 0V; V_{CM} = V_{OUT} = half supply, unless otherwise noted.

SYMBOL	PARAMETER	CONDITIONS	MIN	TYP	MAX	UNITS	
PSRR	Power Supply Rejection Ratio	V _S = 3V to 12V, V _{CM} = V _O = 0.5V	●	82	101	dB	
	PSRR Match (Channel-to-Channel) (Note 5)	V _S = 3V to 12V, V _{CM} = V _O = 0.5V	●	78	102	dB	
	Minimum Supply Voltage (Note 9)	V _{CM} = V _O = 0.5V	●		2.6	2.7	V
V _{OL}	Output Voltage Swing Low (Note 6)	No Load	●		17	40	mV
		I _{SINK} = 0.5mA	●		36	80	mV
		I _{SINK} = 25mA, V _S = 5V	●		700	1400	mV
		I _{SINK} = 20mA, V _S = 3V	●		560	1200	mV
V _{OH}	Output Voltage Swing High (Note 6)	No Load	●		16	40	mV
		I _{SOURCE} = 0.5mA	●		50	100	mV
		I _{SOURCE} = 15mA, V _S = 5V	●		820	1600	mV
		I _{SOURCE} = 10mA, V _S = 3V	●		550	1100	mV
I _{SC}	Short-Circuit Current	V _S = 5V	●	±18	±36	mA	
		V _S = 3V	●	±13	±25	mA	
I _S	Supply Current per Amplifier		●	4.0	5.1	mA	
GBW	Gain-Bandwidth Product (Note 7)	f = 100kHz	●	14	28	MHz	
SR	Slew Rate (Note 8)	V _S = 5V, A _V = -1, R _L = Open, V _O = 4V	●	4.2	8.3	V/μs	
		V _S = 3V, A _V = -1, R _L = Open	●	3.9	7.7	V/μs	

-40°C < T_A < 85°C, V_S = 5V, 0V; V_S = 3V, 0V; V_{CM} = V_{OUT} = half supply, unless otherwise noted. (Note 4)

SYMBOL	PARAMETER	CONDITIONS	MIN	TYP	MAX	UNITS	
V _{OS}	Input Offset Voltage	V _{CM} = V ⁺ - 0.1V	●		250	775	μV
		V _{CM} = V ⁻ + 0.2V	●		250	775	μV
V _{OS} TC	Input Offset Voltage Drift (Note 3)		●		2.5	5.5	μV/°C
		V _{CM} = V ⁺ - 0.1V	●		1	3.5	μV/°C
ΔV _{OS}	Input Offset Voltage Shift	V _{CM} = V ⁻ + 0.2V to V ⁺ - 0.1V	●		200	750	μV
		Input Offset Voltage Match (Channel-to-Channel)	●		210	1500	μV
I _B	Input Bias Current	V _{CM} = V ⁺ - 0.1V	●	0	650	1300	nA
		V _{CM} = V ⁻ + 0.2V	●	-1300	-650	0	nA
ΔI _B	Input Bias Current Shift	V _{CM} = V ⁻ + 0.2V to V ⁺ - 0.1V	●		1300	2600	nA
		Input Bias Current Match (Channel-to-Channel)	●		25	390	nA
I _{OS}	Input Offset Current	V _{CM} = V ⁺ - 0.1V	●		25	195	nA
		V _{CM} = V ⁻ + 0.2V	●		25	195	nA
ΔI _{OS}	Input Offset Current Shift	V _{CM} = V ⁻ + 0.2V to V ⁺ - 0.1V	●		50	390	nA
A _{VOL}	Large-Signal Voltage Gain	V _S = 5V, V _O = 300mV to 4.7V, R _L = 10k	●	400	3500	V/mV	
		V _S = 3V, V _O = 300mV to 2.7V, R _L = 10k	●	300	1800	V/mV	
CMRR	Common Mode Rejection Ratio	V _S = 5V, V _{CM} = V ⁻ + 0.2V to V ⁺ - 0.1V	●	75	87	dB	
		V _S = 3V, V _{CM} = V ⁻ + 0.2V to V ⁺ - 0.1V	●	71	83	dB	
		CMRR Match (Channel-to-Channel) (Note 5)	●	69	89	dB	
PSRR	Power Supply Rejection Ratio	V _S = 3V to 12V, V _{CM} = V _O = 0.5V	●	82	98	dB	
		PSRR Match (Channel-to-Channel) (Note 5)	●	78	102	dB	
		Minimum Supply Voltage (Note 9)	●		2.6	2.7	V
V _{OL}	Output Voltage Swing Low (Note 6)	No Load	●		18	40	mV
		I _{SINK} = 0.5mA	●		38	80	mV
		I _{SINK} = 25mA, V _S = 5V	●		730	1500	mV
		I _{SINK} = 20mA, V _S = 3V	●		580	1200	mV

sn16301 16301fs

ELECTRICAL CHARACTERISTICS

$-40^{\circ}\text{C} < T_A < 85^{\circ}\text{C}$, $V_S = 5\text{V}, 0\text{V}; V_S = 3\text{V}, 0\text{V}; V_{CM} = V_{OUT} = \text{half supply}$, unless otherwise noted. (Note 4)

SYMBOL	PARAMETER	CONDITIONS	MIN	TYP	MAX	UNITS
V _{OH}	Output Voltage Swing High (Note 6)	No Load		15	40	mV
		I _{SOURCE} = 0.5mA		55	110	mV
		I _{SOURCE} = 15mA, V _S = 5V		860	1700	mV
		I _{SOURCE} = 10mA, V _S = 3V		580	1200	mV
I _{SC}	Short-Circuit Current	V _S = 5V	±17	±34		mA
		V _S = 3V	±12	±24		mA
I _S	Supply Current per Amplifier			4.1	5.2	mA
GBW	Gain-Bandwidth Product (Note 7)	f = 100kHz	14	28		MHz
SR	Slew Rate (Note 8)	V _S = 5V, A _V = -1, R _L = Open, V _O = 4V	3.5	7		V/μs
		V _S = 3V, A _V = -1, R _L = Open	3.3	6.5		V/μs

$T_A = 25^{\circ}\text{C}$, $V_S = \pm 15\text{V}$, $V_{CM} = 0\text{V}$, $V_{OUT} = 0\text{V}$, unless otherwise noted.

SYMBOL	PARAMETER	CONDITIONS	MIN	TYP	MAX	UNITS
V _{OS}	Input Offset Voltage	V _{CM} = V ⁺		220	1000	μV
		V _{CM} = V ⁻		220	1000	μV
ΔV _{OS}	Input Offset Voltage Shift	V _{CM} = V ⁻ to V ⁺		150	1000	μV
		Input Offset Voltage Match (Channel-to-Channel)	V _{CM} = V ⁻ , V ⁺ (Note 5)		200	1500
I _B	Input Bias Current	V _{CM} = V ⁺	0	550	1100	nA
		V _{CM} = V ⁻	-1100	-550	0	nA
ΔI _B	Input Bias Current Shift	V _{CM} = V ⁻ to V ⁺		1100	2200	nA
		Input Bias Current Match (Channel-to-Channel)	V _{CM} = V ⁺ (Note 5) V _{CM} = V ⁻ (Note 5)		20	300
I _{OS}	Input Offset Current	V _{CM} = V ⁺		20	150	nA
		V _{CM} = V ⁻		20	150	nA
ΔI _{OS}	Input Offset Current Shift	V _{CM} = V ⁻ to V ⁺		40	300	nA
		Input Noise Voltage	0.1Hz to 10Hz		300	
e _n	Input Noise Voltage Density	f = 1kHz		6		nV/√Hz
i _n	Input Noise Current Density	f = 1kHz		0.9		pA/√Hz
C _{IN}	Input Capacitance	f = 100kHz		3		pF
A _{VOL}	Large-Signal Voltage Gain	V _O = -14.5V to 14.5V, R _L = 10k	1000	5000		V/mV
		V _O = -10V to 10V, R _L = 2k	650	3500		V/mV
	Channel Separation	V _O = -10V to 10V, R _L = 2k	112	134		dB
CMRR	Common Mode Rejection Ratio	V _{CM} = V ⁻ to V ⁺	89	106		dB
		CMRR Match (Channel-to-Channel) (Note 5)	86	110		dB
PSRR	Power Supply Rejection Ratio	V _S = ±5V to ±15V	87	105		dB
		PSRR Match (Channel-to-Channel) (Note 5)	82	107		dB
V _{OL}	Output Voltage Swing Low (Note 6)	No Load		16	35	mV
		I _{SINK} = 5mA		150	300	mV
		I _{SINK} = 25mA		600	1200	mV
V _{OH}	Output Voltage Swing High (Note 6)	No Load		15	40	mV
		I _{SOURCE} = 5mA		250	500	mV
		I _{SOURCE} = 25mA		1200	2400	mV

ELECTRICAL CHARACTERISTICS

$T_A = 25^\circ\text{C}$, $V_S = \pm 15\text{V}$, $V_{CM} = 0\text{V}$, $V_{OUT} = 0\text{V}$, unless otherwise noted.

SYMBOL	PARAMETER	CONDITIONS	MIN	TYP	MAX	UNITS
I_{SC}	Short-Circuit Current		± 35	± 70		mA
I_S	Supply Current per Amplifier			4.1	5.0	mA
GBW	Gain-Bandwidth Product (Note 7)	$f = 100\text{kHz}$	15	30		MHz
SR	Slew Rate	$A_V = -1$, $R_L = \text{Open}$, $V_O = \pm 10\text{V}$, Measure at $V_O = \pm 5\text{V}$	5	10		V/ μs
t_S	Settling Time	0.01%, $V_{STEP} = 10\text{V}$, $A_V = 1$, $R_L = 1\text{k}$		1.2		μs

$0^\circ\text{C} < T_A < 70^\circ\text{C}$, $V_S = \pm 15\text{V}$, $V_{CM} = 0\text{V}$, $V_{OUT} = 0\text{V}$, unless otherwise noted.

SYMBOL	PARAMETER	CONDITIONS	MIN	TYP	MAX	UNITS
V_{OS}	Input Offset Voltage	$V_{CM} = V^+ - 0.1\text{V}$ $V_{CM} = V^- + 0.2\text{V}$		300	1250	μV μV
$V_{OS\ TC}$	Input Offset Voltage Drift (Note 3)	$V_{CM} = V^+ - 0.1\text{V}$		4.5	7	$\mu\text{V}/^\circ\text{C}$ $\mu\text{V}/^\circ\text{C}$
ΔV_{OS}	Input Offset Voltage Shift	$V_{CM} = V^- + 0.2\text{V}$ to $V^+ - 0.1\text{V}$		180	1100	μV
	Input Offset Voltage Match (Channel-to-Channel)	$V_{CM} = V^- + 0.2\text{V}$, $V^+ - 0.1\text{V}$ (Note 5)		300	2000	μV
I_B	Input Bias Current	$V_{CM} = V^+ - 0.1\text{V}$ $V_{CM} = V^- + 0.2\text{V}$	0 -1200	600 -600	1200 0	nA nA
ΔI_B	Input Bias Current Shift	$V_{CM} = V^- + 0.2\text{V}$ to $V^+ - 0.1\text{V}$		1200	2400	nA
	Input Bias Current Match (Channel-to-Channel)	$V_{CM} = V^+ - 0.1\text{V}$ (Note 5) $V_{CM} = V^- + 0.2\text{V}$ (Note 5)		30	350	nA nA
I_{OS}	Input Offset Current	$V_{CM} = V^+ - 0.1\text{V}$ $V_{CM} = V^- + 0.2\text{V}$		25	175	nA nA
ΔI_{OS}	Input Offset Current Shift	$V_{CM} = V^- + 0.2\text{V}$ to $V^+ - 0.1\text{V}$		50	350	nA
A_{VOL}	Large-Signal Voltage Gain	$V_O = -14.5\text{V}$ to 14.5V , $R_L = 10\text{k}$ $V_O = -10\text{V}$ to 10V , $R_L = 2\text{k}$	900 600	6000 4000		V/mV V/mV
	Channel Separation	$V_O = -10\text{V}$ to 10V , $R_L = 2\text{k}$	112	132		dB
CMRR	Common Mode Rejection Ratio	$V_{CM} = V^- + 0.2\text{V}$ to $V^+ - 0.1\text{V}$	88	104		dB
	CMRR Match (Channel-to-Channel) (Note 5)	$V_{CM} = V^- + 0.2\text{V}$ to $V^+ - 0.1\text{V}$	84	104		dB
PSRR	Power Supply Rejection Ratio	$V_S = \pm 5\text{V}$ to $\pm 15\text{V}$	86	100		dB
	PSRR Match (Channel-to-Channel) (Note 5)	$V_S = \pm 5\text{V}$ to $\pm 15\text{V}$	80	104		dB
V_{OL}	Output Voltage Swing Low (Note 6)	No Load $I_{SINK} = 5\text{mA}$ $I_{SINK} = 25\text{mA}$		19 175 670	45 350 1400	mV mV mV
V_{OH}	Output Voltage Swing High (Note 6)	No Load $I_{SOURCE} = 5\text{mA}$ $I_{SOURCE} = 25\text{mA}$		15 300 1400	40 600 2800	mV mV mV
I_{SC}	Short-Circuit Current		± 28	± 57		mA
I_S	Supply Current per Amplifier			4.6	5.6	mA
GBW	Gain-Bandwidth Product (Note 7)	$f = 100\text{kHz}$	14	28		MHz
SR	Slew Rate	$A_V = -1$, $R_L = \text{Open}$, $V_O = \pm 10\text{V}$, Measured at $V_O = \pm 5\text{V}$	4.5	9		V/ μs

ELECTRICAL CHARACTERISTICS

–40°C < T_A < 85°C, V_S = ±15V, V_{CM} = 0V, V_{OUT} = 0V, unless otherwise noted. (Note 4)

SYMBOL	PARAMETER	CONDITIONS	MIN	TYP	MAX	UNITS
V _{OS}	Input Offset Voltage	V _{CM} = V ⁺ – 0.1V	●	350	1400	μV
		V _{CM} = V [–] + 0.2V	●	350	1400	μV
V _{OS} TC	Input Offset Voltage Drift (Note 3)	V _{CM} = V ⁺ – 0.1V	●	4.5	7	μV/°C
			●	1.5	4	μV/°C
ΔV _{OS}	Input Offset Voltage Shift	V _{CM} = V [–] + 0.2V to V ⁺ – 0.1V	●	180	1200	μV
	Input Offset Voltage Match (Channel-to-Channel)	V _{CM} = V [–] + 0.2V, V ⁺ – 0.1V (Note 5)	●	350	2200	μV
I _B	Input Bias Current	V _{CM} = V ⁺ – 0.1V	●	0	690	nA
		V _{CM} = V [–] + 0.2V	●	–1400	–690	nA
ΔI _B	Input Bias Current Shift	V _{CM} = V [–] + 0.2V to V ⁺ – 0.1V	●	1380	2800	nA
	Input Bias Current Match (Channel-to-Channel)	V _{CM} = V ⁺ – 0.1V (Note 5) V _{CM} = V [–] + 0.2V (Note 5)	● ●	30 30	420 420	nA nA
I _{OS}	Input Offset Current	V _{CM} = V ⁺ – 0.1V	●	30	210	nA
		V _{CM} = V [–] + 0.2V	●	30	210	nA
ΔI _{OS}	Input Offset Current Shift	V _{CM} = V [–] + 0.2V to V ⁺ – 0.1V	●	60	420	nA
A _{VOL}	Large-Signal Voltage Gain	V _O = –14.5V to 14.5V, R _L = 10k V _O = –10V to 10V, R _L = 2k	● ●	700 400	6000 4000	V/mV V/mV
	Channel Separation	V _O = –10V to 10V, R _L = 2k	●	112	132	dB
CMRR	Common Mode Rejection Ratio	V _{CM} = V [–] + 0.2V to V ⁺ – 0.1V	●	87	104	dB
	CMRR Match (Channel-to-Channel) (Note 5)	V _{CM} = V [–] + 0.2V to V ⁺ – 0.1V	●	84	104	dB
PSRR	Power Supply Rejection Ratio	V _S = ±5V to ±15V	●	84	100	dB
	PSRR Match (Channel-to-Channel) (Note 5)	V _S = ±5V to ±15V	●	80	100	dB
V _{OL}	Output Voltage Swing Low (Note 6)	No Load	●	22	50	mV
		I _{SINK} = 5mA	●	180	350	mV
		I _{SINK} = 25mA	●	700	1400	mV
V _{OH}	Output Voltage Swing High (Note 6)	No Load	●	15	40	mV
		I _{SOURCE} = 5mA	●	300	600	mV
		I _{SOURCE} = 25mA	●	1500	3000	mV
I _{SC}	Short-Circuit Current		●	±27	±54	mA
I _S	Supply Current per Amplifier		●	4.8	5.9	mA
GBW	Gain-Bandwidth Product (Note 7)	f = 100kHz	●	14	27	MHz
SR	Slew Rate	A _V = –1, R _L = Open, V _O = ±10V, Measure at V _O = ±5V	●	4.2	8.5	V/μs

The ● denotes specifications that apply over the full operating temperature range.

Note 1: Absolute Maximum Ratings are those values beyond which the life of a device may be impaired.

Note 2: A heat sink may be required to keep the junction temperature below the absolute maximum rating when the output is shorted indefinitely.

Note 3: This parameter is not 100% tested.

Note 4: The LT1630C/LT1631C are guaranteed to meet specified performance from 0°C to 70°C and are designed, characterized and expected to meet these extended temperature limits, but are not tested at –40°C and 85°C. Guaranteed I grade parts are available, consult factory.

Note 5: Matching parameters are the difference between amplifiers A and D and between B and C on the LT1631; between the two amplifiers on the LT1630.

Note 6: Output voltage swings are measured between the output and power supply rails.

Note 7: V_S = 3V, V_S = ±15V GBW limit guaranteed by correlation to 5V tests.

Note 8: V_S = 3V, V_S = 5V slew rate limit guaranteed by correlation to ±15V tests.

Note 9: Minimum supply voltage is guaranteed by testing the change of V_{OS} to be less than 250μV when the supply voltage is varied from 3V to 2.7V.

TYPICAL PERFORMANCE CHARACTERISTICS

V_{OS} Distribution, $V_{CM} = 0V$ (PNP Stage)

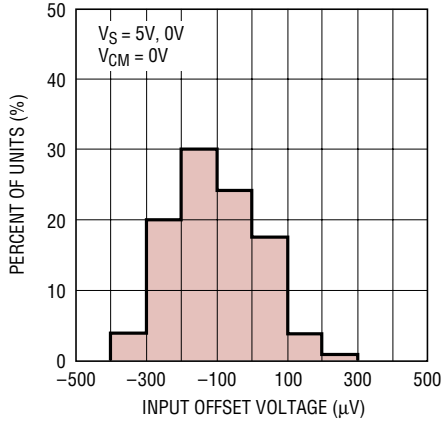

1630/31 G32

V_{OS} Distribution, $V_{CM} = 5V$ (NPN Stage)

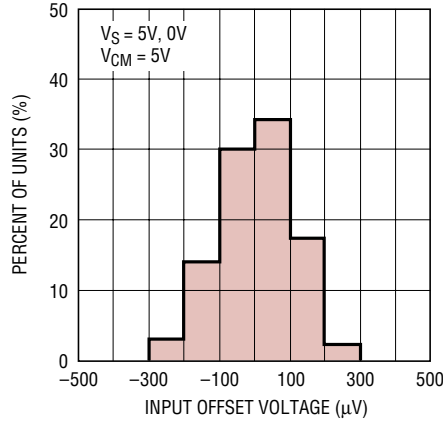

1630/31 G33

ΔV_{OS} Shift for $V_{CM} = 0V$ to $5V$

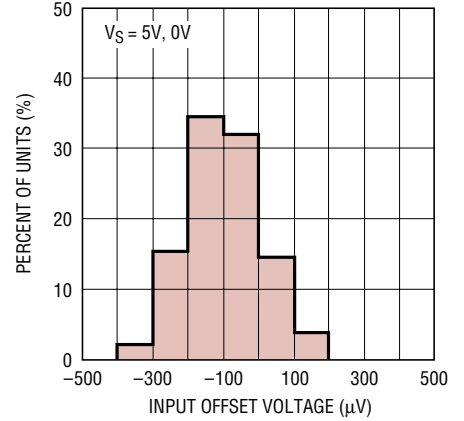

1630/31 G34

Supply Current vs Supply Voltage

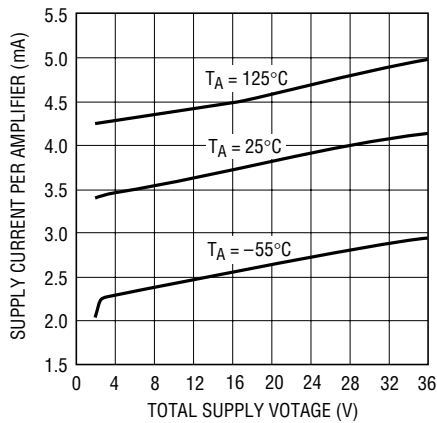

1630/31 G01

Supply Current vs Temperature

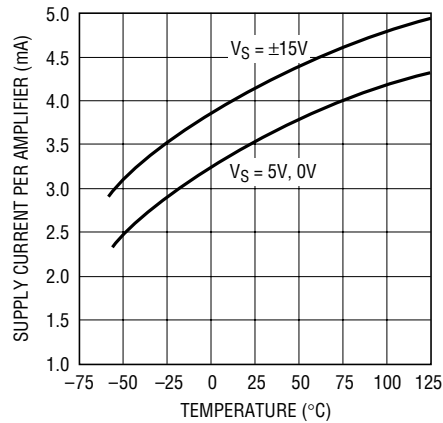

1630/31 G02

Input Bias Current vs Common Mode Voltage

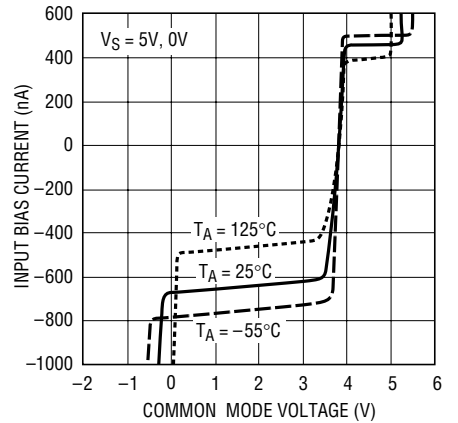

1630/31 G03

Input Bias Current vs Temperature

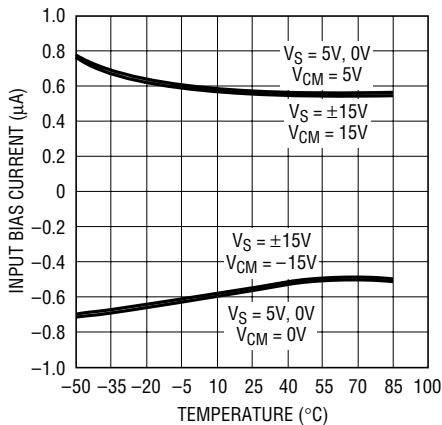

1630/31 G04

Output Saturation Voltage vs Load Current (Output Low)

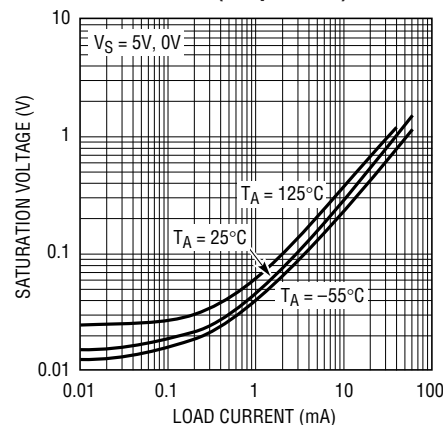

1630/31 G05

Output Saturation Voltage vs Load Current (Output High)

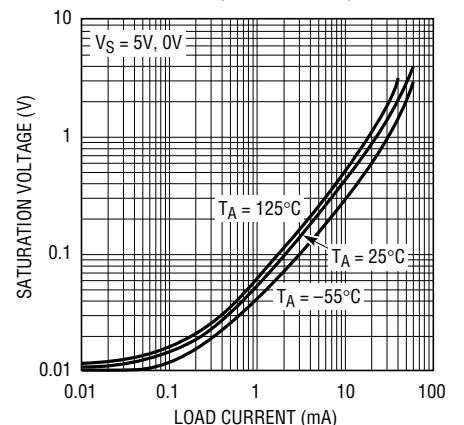

1630/31 G06

TYPICAL PERFORMANCE CHARACTERISTICS

Minimum Supply Voltage

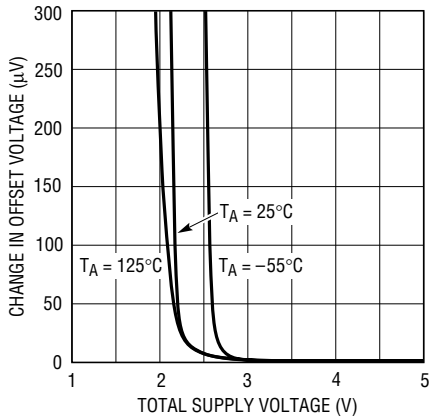

1630/31 G07

Noise Voltage Spectrum

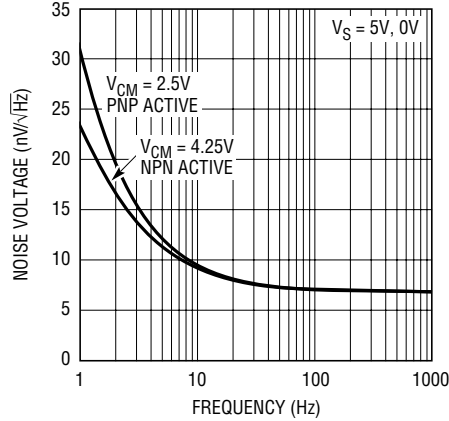

11630/31 G09

Current Noise Spectrum

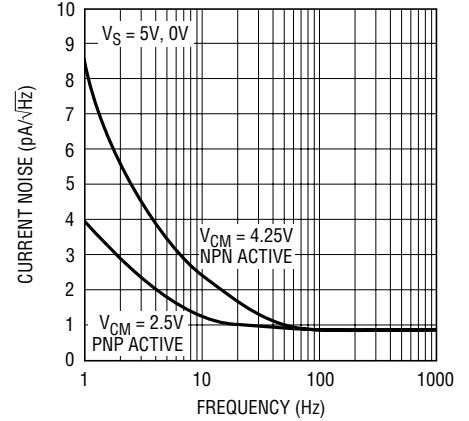

1630/31 G10

0.1Hz to 10Hz Output Voltage Noise

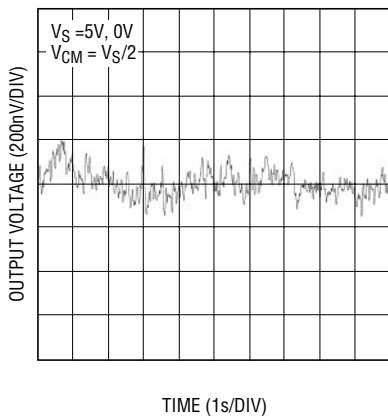

1630/31 G25

Gain and Phase vs Frequency

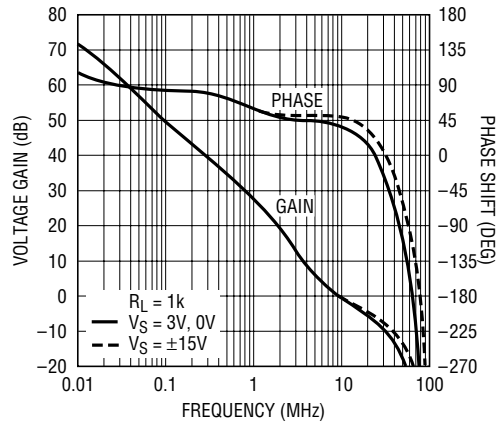

1630/31 G11

Gain Bandwidth and Phase Margin vs Supply Voltage

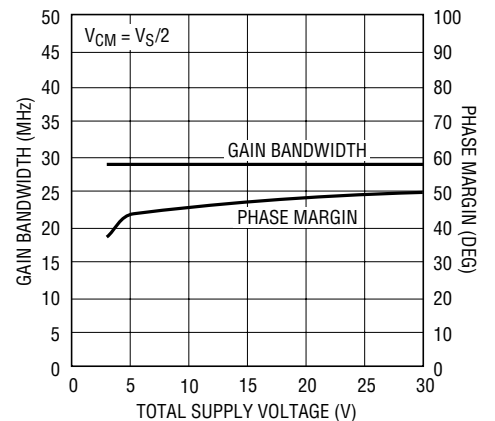

1630/31 G14

CMRR vs Frequency

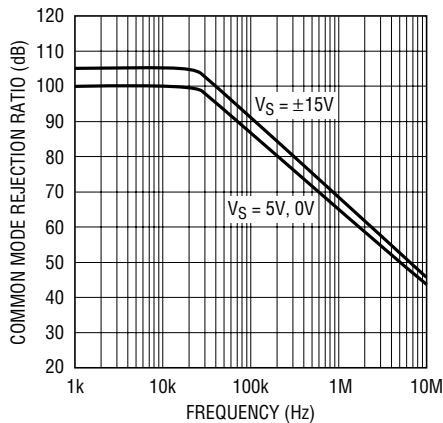

1630/31 G12

PSRR vs Frequency

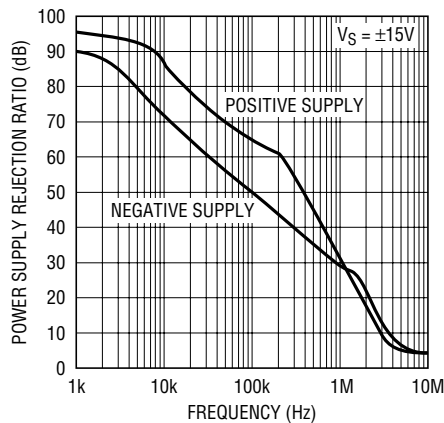

1630/31 G13

Channel Separation vs Frequency

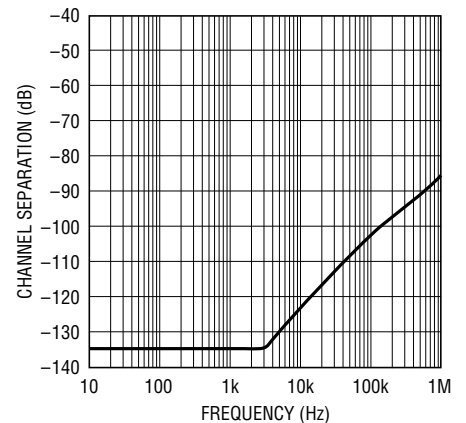

1630/31 G15

TYPICAL PERFORMANCE CHARACTERISTICS

Capacitive Load Handling

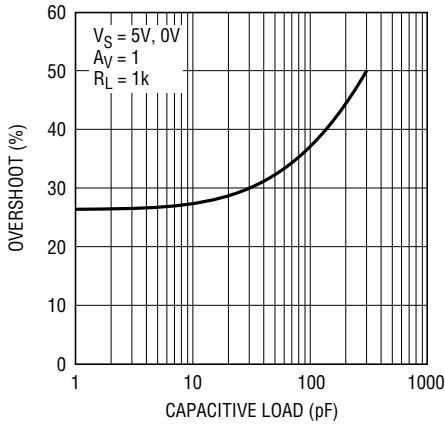

1630/31 G16

Slew Rate vs Supply Voltage

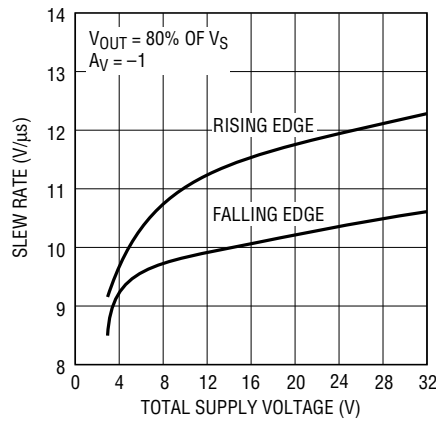

1630/31 G17

Output Step vs Settling Time to 0.01%

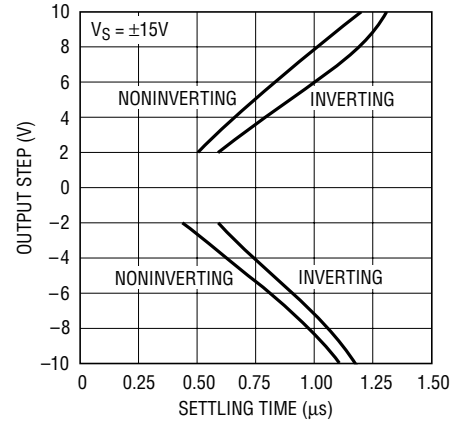

1630/31 G18

Open-Loop Gain

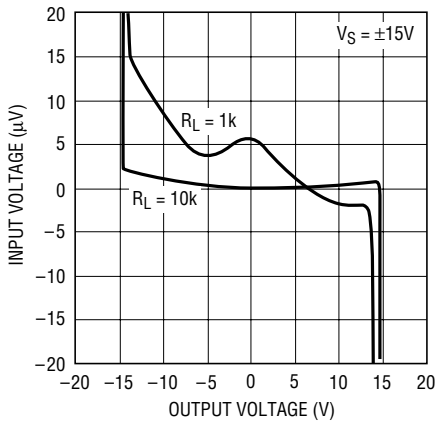

1630/31 G19

Open-Loop Gain

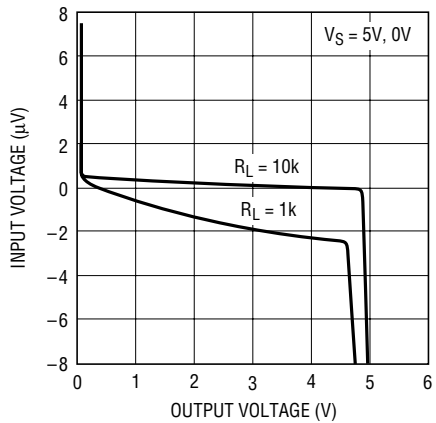

1630/31 G20

Open-Loop Gain

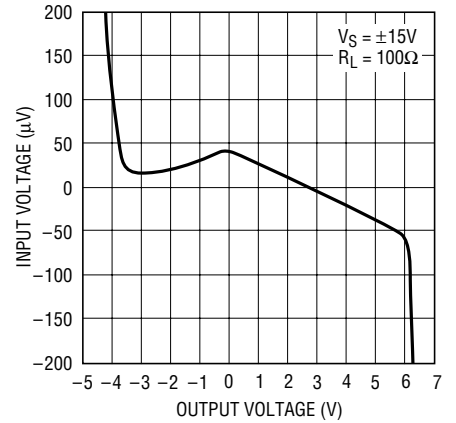

1630/31 G21

Warm-Up Drift vs Time

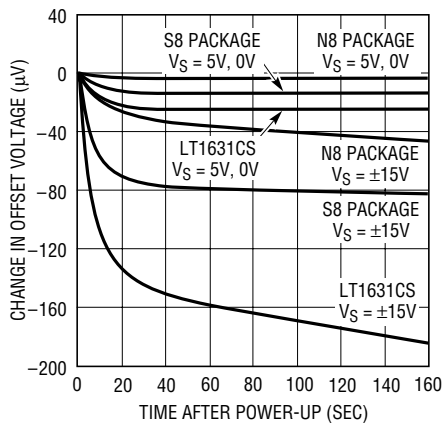

1630/31 G22

Maximum Undistorted Output Signal vs Frequency

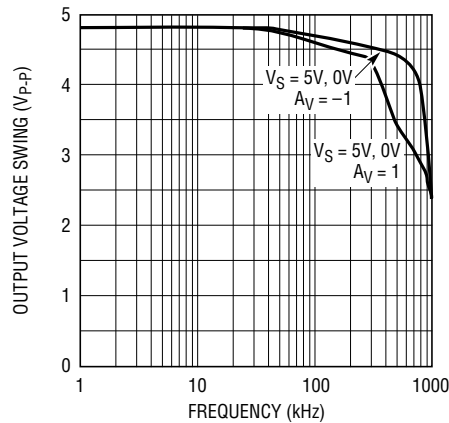

1630/31 G24

Total Harmonic Distortion + Noise vs Frequency

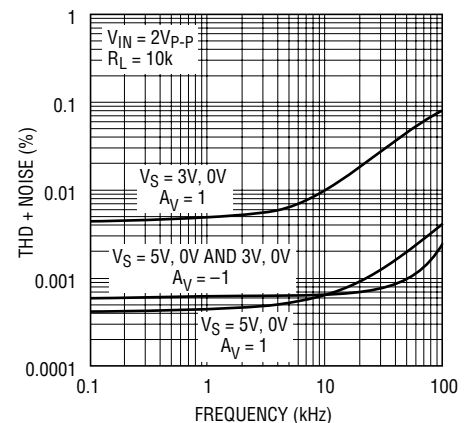

163031 G23

TYPICAL PERFORMANCE CHARACTERISTICS

Harmonic Distortion vs Frequency

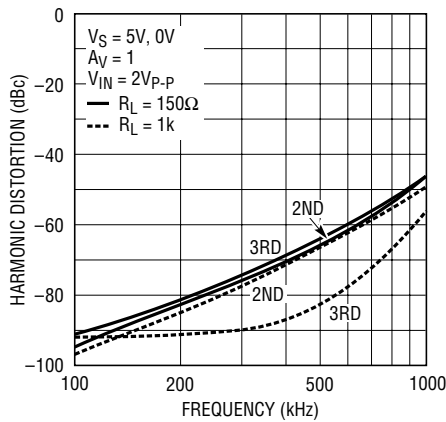

5V Small-Signal Response

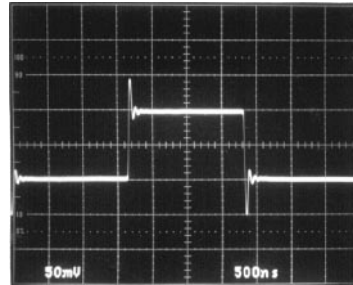

$V_S = 5V, 0V$
 $A_V = 1$
 $R_L = 1k$

5V Large-Signal Response

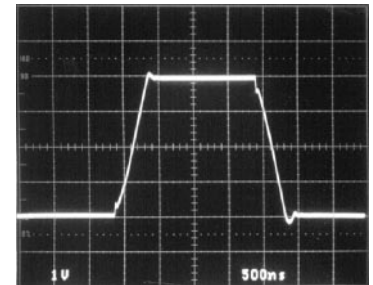

$V_S = 5V, 0V$
 $A_V = 1$
 $R_L = 1k$

Harmonic Distortion vs Frequency

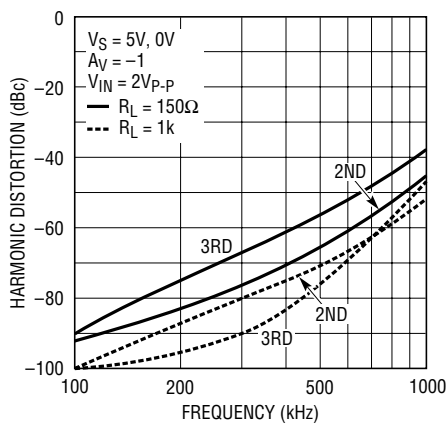

±15V Small-Signal Response

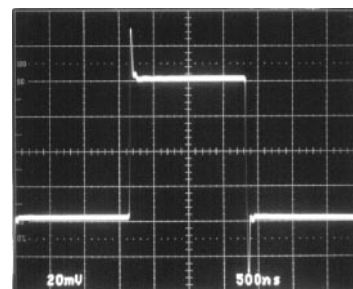

$V_S = \pm 15V$
 $A_V = 1$
 $R_L = 1k$

±15V Large-Signal Response

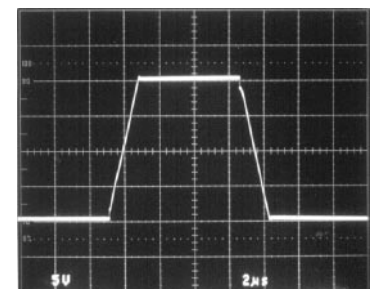

$V_S = \pm 15V$
 $A_V = 1$
 $R_L = 1k$

APPLICATIONS INFORMATION

Rail-to-Rail Input and Output

The LT1630/LT1631 are fully functional for an input and output signal range from the negative supply to the positive supply. Figure 1 shows a simplified schematic of the amplifier. The input stage consists of two differential amplifiers, a PNP stage Q1/Q2 and an NPN stage Q3/Q4 that are active over different ranges of input common mode voltage. The PNP differential input pair is active for input common mode voltages V_{CM} between the negative supply to approximately 1.4V below the positive supply. As V_{CM} moves closer toward the positive supply, the

transistor Q5 will steer the tail current I_1 to the current mirror Q6/Q7, activating the NPN differential pair and the PNP pair becomes inactive for the rest of the input common mode range up to the positive supply.

The output is configured with a pair of complementary common emitter stages Q14/Q15 that enables the output to swing from rail to rail. These devices are fabricated on Linear Technology's proprietary complementary bipolar process to ensure similar DC and AC characteristics. Capacitors C1 and C2 form local feedback loops that lower the output impedance at high frequencies.

APPLICATIONS INFORMATION

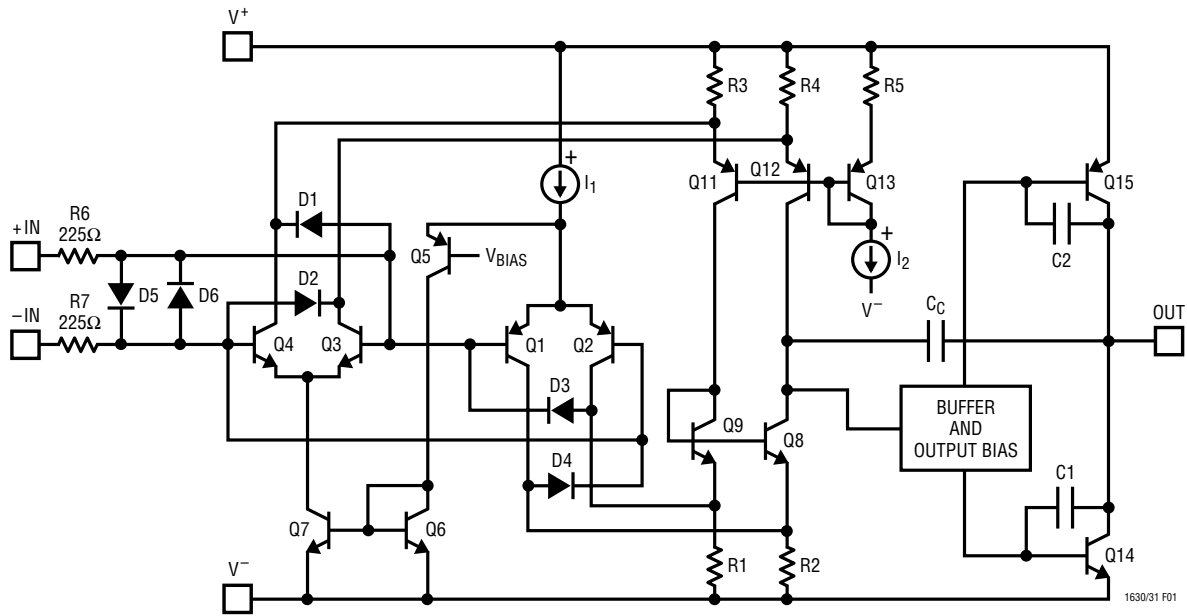

Figure 1. LT1630 Simplified Schematic Diagram

Power Dissipation

The LT1630/LT1631 amplifiers combine high speed and large output current drive in a small package. Because the amplifiers operate over a very wide supply range, it is possible to exceed the maximum junction temperature of 150°C in plastic packages under certain conditions. Junction temperature T_J is calculated from the ambient temperature T_A and power dissipation P_D as follows:

$$\begin{aligned} \text{LT1630CN8: } T_J &= T_A + (P_D \cdot 130^\circ\text{C/W}) \\ \text{LT1630CS8: } T_J &= T_A + (P_D \cdot 190^\circ\text{C/W}) \\ \text{LT1631CS: } T_J &= T_A + (P_D \cdot 150^\circ\text{C/W}) \end{aligned}$$

The power dissipation in the IC is the function of the supply voltage, output voltage and load resistance. For a given supply voltage, the worst-case power dissipation $P_{D\text{MAX}}$ occurs at the maximum supply current and when the output voltage is at half of either supply voltage (or the maximum swing if less than 1/2 supply voltage). Therefore $P_{D\text{MAX}}$ is given by:

$$P_{D\text{MAX}} = (V_S \cdot I_{S\text{MAX}}) + (V_S/2)^2/R_L$$

To ensure that the LT1630/LT1631 are used properly, calculate the worst-case power dissipation, get the thermal resistance for a chosen package and its maximum junction temperature to derive the maximum ambient temperature.

Example: An LT1630CS8 operating on $\pm 15\text{V}$ supplies and driving a 500Ω , the worst-case power dissipation per amplifier is given by:

$$\begin{aligned} P_{D\text{MAX}} &= (30\text{V} \cdot 4.75\text{mA}) + (15\text{V} - 7.5\text{V})(7.5/500) \\ &= 0.143 + 0.113 = 0.256\text{W} \end{aligned}$$

If both amplifiers are loaded simultaneously, then the total power dissipation is 0.512W . The SO-8 package has a junction-to-ambient thermal resistance of 190°C/W in still air. Therefore, the maximum ambient temperature that the part is allowed to operate is:

$$\begin{aligned} T_A &= T_J - (P_{D\text{MAX}} \cdot 190^\circ\text{C/W}) \\ T_A &= 150^\circ\text{C} - (0.512\text{W} \cdot 190^\circ\text{C/W}) = 53^\circ\text{C} \end{aligned}$$

For a higher operating temperature, lower the supply voltage or use the DIP package part.

APPLICATIONS INFORMATION

Input Offset Voltage

The offset voltage changes depending upon which input stage is active, and the maximum offset voltages are trimmed to less than $525\mu\text{V}$. To maintain the precision characteristics of the amplifier, the change of V_{OS} over the entire input common mode range (CMRR) is guaranteed to be less than $525\mu\text{V}$ on a single 5V supply.

Input Bias Current

The input bias current polarity depends on the input common mode voltage. When the PNP differential pair is active, the input bias currents flow out of the input pins. They flow in the opposite direction when the NPN input stage is active. The offset voltage error due to input bias currents can be minimized by equalizing the noninverting and inverting input source impedance.

Output

The outputs of the LT1630/LT1631 can deliver large load currents; the short-circuit current limit is 70mA. Take care to keep the junction temperature of the IC below the absolute maximum rating of 150°C (refer to the Power Dissipation section). The output of these amplifiers have reverse-biased diodes to each supply. If the output is forced beyond either supply, unlimited current will flow through these diodes. If the current is transient and limited to several hundred mA, no damage to the part will occur.

Overdrive Protection

To prevent the output from reversing polarity when the input voltage exceeds the power supplies, two pairs of crossing diodes D1 to D4 are employed. When the input voltage exceeds either power supply by approximately 700mV, D1/D2 or D3/D4 will turn on, forcing the output to the proper polarity. For this phase reversal protection to work properly, the input current must be limited to less than 5mA. If the amplifier is to be severely overdriven, an external resistor should be used to limit the overdrive current.

The LT1630/LT1631's input stages are protected against large differential input voltages by a pair of back-to-back diodes D5/D6. When a differential voltage of more than 0.7V is applied to the inputs, these diodes will turn on, preventing the emitter-base breakdown of the input transistors. The current in D5/D6 should be limited to less than 10mA. Internal 225Ω resistors R6 and R7 will limit the input current for differential input signals of 4.5V or less. For larger input levels, a resistor in series with either or both inputs should be used to limit the current. Worst-case differential input voltage usually occurs when the output is shorted to ground. In addition, the amplifier is protected against ESD strikes up to 3kV on all pins.

Capacitive Load

The LT1630/LT1631 are wideband amplifiers that can drive capacitive loads up to 200pF on $\pm 15\text{V}$ supplies in a unity-gain configuration. On a 3V supply, the capacitive load should be kept to less than 100pF. When there is a need to drive larger capacitive loads, a resistor of 20Ω to 50Ω should be connected between the output and the capacitive load. The feedback should still be taken from the output so that the resistor isolates the capacitive load to ensure stability.

Feedback Components

The low input bias currents of the LT1630/LT1631 make it possible to use the high value feedback resistors to set the gain. However, care must be taken to ensure that the pole formed by the feedback resistors and the total capacitance at the inverting input does not degrade stability. For instance, the LT1630/LT1631 in a noninverting gain of 2, set with two 20k resistors, will probably oscillate with 10pF total input capacitance (5pF input capacitance and 5pF board capacitance). The amplifier has a 5MHz crossing frequency and a 52° phase margin at 6dB of gain. The feedback resistors and the total input capacitance form a pole at 1.6MHz that induces a phase shift of 72° at 5MHz! The solution is simple: either lower the value of the resistors or add a feedback capacitor of 10pF or more.

TYPICAL APPLICATIONS

Single Supply, 40dB Gain, 350kHz Instrumentation Amplifier

An instrumentation amplifier with a rail-to-rail output swing, operating from a 3V supply can be constructed with the LT1630 as shown in Figure 2. The amplifier has a nominal gain of 100, which can be adjusted with resistor R5. The DC output level is set by the difference of the two inputs multiplied by the gain of 100. Common mode range can be calculated by the equations shown with Figure 2. For example, the common mode range is from 0.15V to 2.65V if the output is set at one half of the 3V supply. The common mode rejection is greater than 110dB at 100Hz when trimmed with resistor R1. The amplifier has a bandwidth of 355kHz as shown in Figure 3.

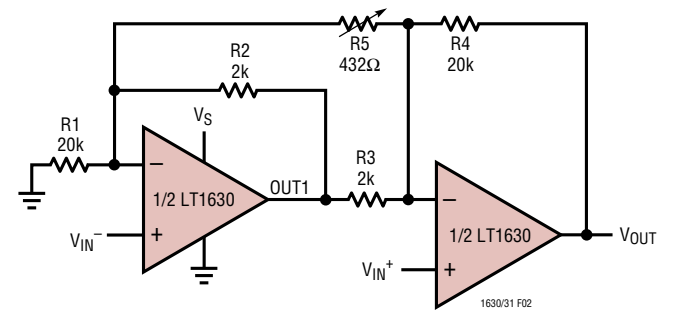

BW = 355kHz

$$A_V = \frac{R_4}{R_3} \left(1 + \frac{R_2}{R_1} + \frac{R_3 + R_2}{R_5} \right) = 100$$

$$V_{OUT} = (V_{IN}^+ - V_{IN}^-) \cdot A_V$$

LOWER LIMIT COMMON MODE INPUT VOLTAGE

$$V_{CML} = \left[\left(\frac{V_{OUT}}{A_V} \right) \frac{R_2}{R_5} + 0.1V \right] \frac{1.0}{1.1}$$

UPPER LIMIT COMMON MODE INPUT VOLTAGE

$$V_{CMH} = \left[\left(\frac{V_{OUT}}{A_V} \right) \frac{R_2}{R_5} + (V_S - 0.15V) \right] \frac{1.0}{1.1}$$

WHERE V_S IS THE SUPPLY VOLTAGE

Figure 2. Single Supply, 40dB Gain Instrumentation Amplifier

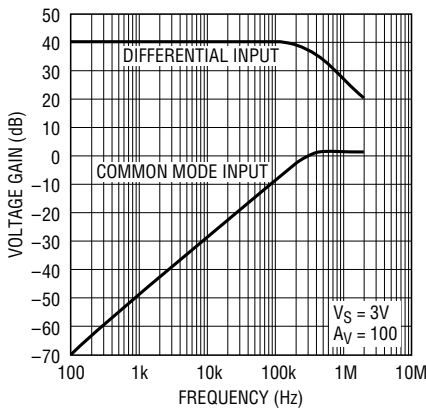

Figure 3. Frequency Response

Tunable Q Notch Filter

A single supply, tunable Q notch filter as shown in Figure 4 is built with LT1630 to maximize the output swing. The filter has a gain of 2, and the notch frequency (f_0) is set by the values of R and C. The resistors R10 and R11 set up the DC level at the output. The Q factor can be adjusted by varying the value of R8. The higher value of R8 will decrease Q as depicted in Figure 5, because the output induces less of feedback to amplifier A2. The value of R7 should be equal or greater than R9 to prevent oscillation. If R8 is a short and R9 is larger than R7, then the positive feedback from the output will create phase inversion at the output of amplifier A2, which will lead to oscillation.

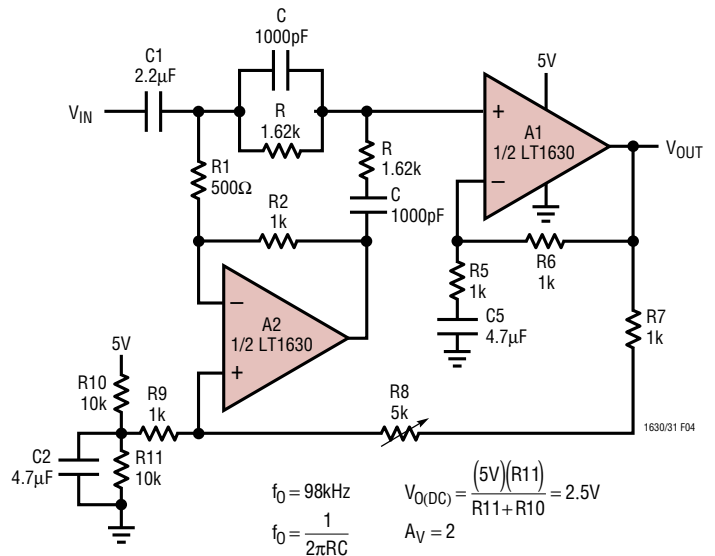

Figure 4. Tunable Q Notch Filter

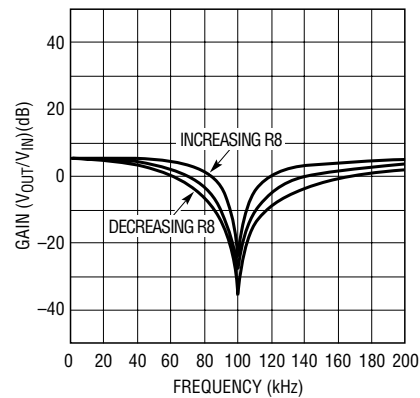
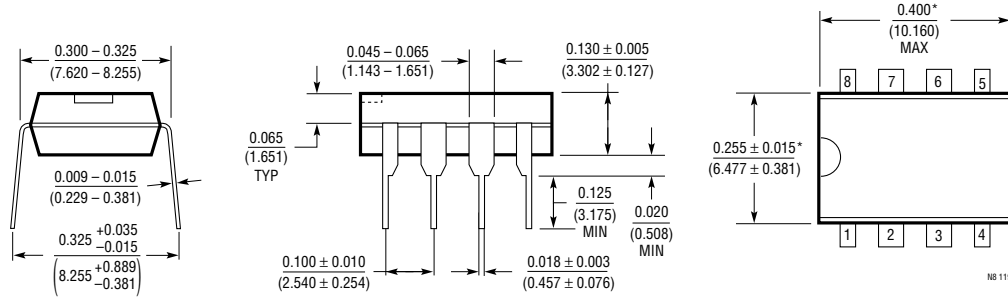

Figure 5. Frequency Response

PACKAGE DESCRIPTION Dimensions in inches (millimeters) unless otherwise noted.

N8 Package
8-Lead PDIP (Narrow 0.300)
 (LTC DWG # 05-08-1510)



*THESE DIMENSIONS DO NOT INCLUDE MOLD FLASH OR PROTRUSIONS.
 MOLD FLASH OR PROTRUSIONS SHALL NOT EXCEED 0.010 INCH (0.254mm)

S8 Package
8-Lead Plastic Small Outline (Narrow 0.150)
 (LTC DWG # 05-08-1610)

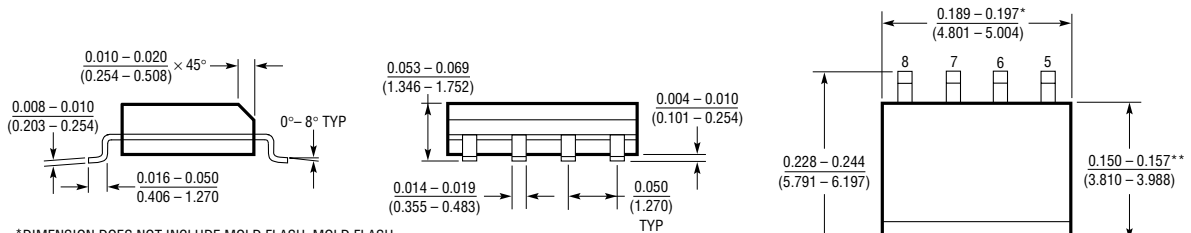

DIMENSION DOES NOT INCLUDE MOLD FLASH. MOLD FLASH SHALL NOT EXCEED 0.006 (0.152mm) PER SIDE

**DIMENSION DOES NOT INCLUDE INTERLEAD FLASH. INTERLEAD FLASH SHALL NOT EXCEED 0.010* (0.254mm) PER SIDE

S Package
14-Lead Plastic Small Outline (Narrow 0.150)
 (LTC DWG # 05-08-1610)

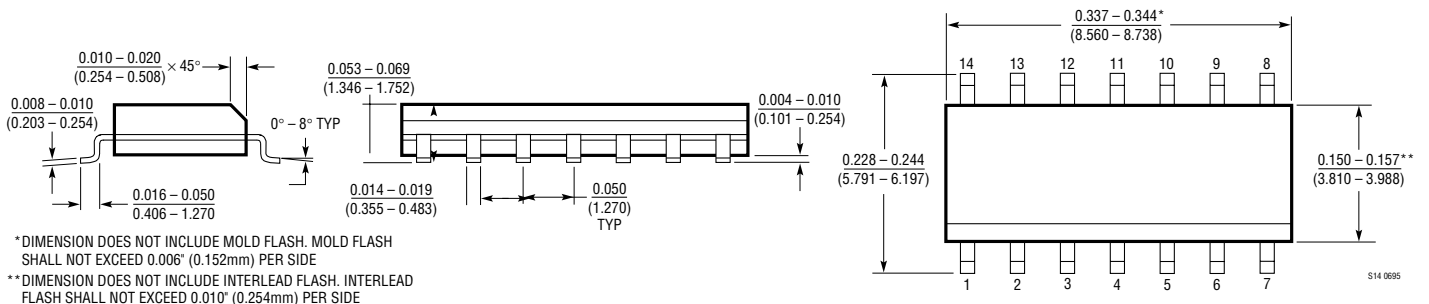

DIMENSION DOES NOT INCLUDE MOLD FLASH. MOLD FLASH SHALL NOT EXCEED 0.006 (0.152mm) PER SIDE

**DIMENSION DOES NOT INCLUDE INTERLEAD FLASH. INTERLEAD FLASH SHALL NOT EXCEED 0.010* (0.254mm) PER SIDE

