

PLEASE CHECK WWW.MOLEX.COM FOR LATEST PART INFORMATION

Part Number: [0442480001](#)
Status: **Active**
Overview: [modular_plugs_jacks](#)
Description: Modular Jack, Right Angle, Low Profile, Inverted, Lightpipes, 8/8, 2 Ports

Documents:

[3D Model](#) [Product Specification PS-43860-003 \(PDF\)](#)
[Drawing \(PDF\)](#) [RoHS Certificate of Compliance \(PDF\)](#)

Agency Certification

CSA LR19980
 UL E107635

General

Product Family Modular Jacks/Plugs
 Series [44248](#)
 Comments Industry Compatible
 Component Type PCB Jack
 Magnetic No
 Overview [modular_plugs_jacks](#)
 Performance Category 3
 Power over Ethernet (PoE) N/A
 Product Name RJ45

Physical

Boot Color N/A
 Color - Resin Black, Clear
 Durability (mating cycles max) 500
 Flammability 94V-0
 Inverted / Top Latch Yes
 Lightpipes/LEDs Lightpipes
 Material - Metal Phosphor Bronze
 Material - Plating Mating Gold
 Material - Plating Termination Tin
 Material - Resin Polycarbonate, Polyester
 Orientation Right Angle (Side Entry)
 PCB Locator Yes
 PCB Retention Yes
 PCB Thickness Recommended (in) 0.062 In
 PCB Thickness Recommended (mm) 1.57 mm
 Packaging Type Tray
 Panel Mount With Flange
 Pitch - Mating Interface (in) 0.040 In
 Pitch - Mating Interface (mm) 1.02 mm
 Pitch - Term. Interface (in) 0.040 In
 Pitch - Term. Interface (mm) 1.02 mm
 Plating min: Mating (µin) 50
 Plating min: Mating (µm) 1.25
 Plating min: Termination (µin) 100
 Plating min: Termination (µm) 2.5
 Ports 2
 Positions / Loaded Contacts 8/8
 Surface Mount Compatible (SMC) No
 Temperature Range - Operating -40°C to +85°C
 Termination Interface: Style Through Hole
 Waterproof / Dustproof No

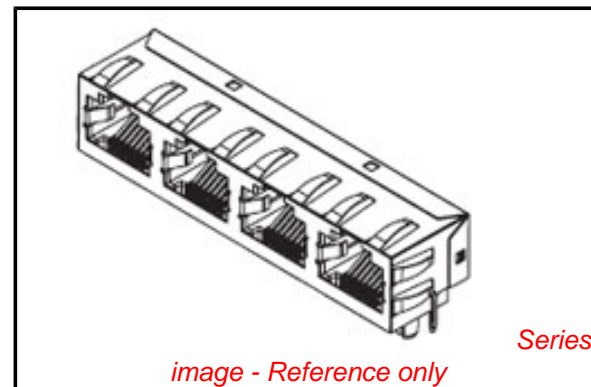

EU RoHS

**ELV and RoHS
 Compliant**
REACH SVHC
 Not Reviewed
**Halogen-Free
 Status**

China RoHS



**Need more information on product
 environmental compliance?**

Email productcompliance@molex.com
 For a multiple part number RoHS Certificate of
 Compliance, [click here](#)

Please visit the [Contact Us](#) section for any
 non-product compliance questions.

Search Parts in this Series

[44248Series](#)

Mates With

FCC 68 Plugs

Wire/Cable Type	N/A
Electrical	
Current - Maximum per Contact	1.5A
Grounding to PCB	No
Shielded	No
Voltage - Maximum	150V AC (RMS)

Solder Process Data

Lead-free Process Capability	Wave Capable (TH only)
------------------------------	------------------------

Material Info**Reference - Drawing Numbers**

Application Specification	AS-43860-001
Packaging Specification	PK-44248-004
Product Specification	PS-43860-003, RPS-43860-004, RPS-43860-007, RPS-43860-008, RPS-43860-013
Sales Drawing	SD-44248-001
Test Summary	TS-43860-001

This document was generated on 06/07/2010

PLEASE CHECK WWW.MOLEX.COM FOR LATEST PART INFORMATION

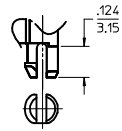

SNAP-FIT PEG OPTION

SCALE: NTS
SEE NOTE #8

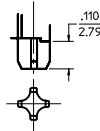

PRESS-FIT PEG OPTION

SCALE: NTS
SEE NOTE #8

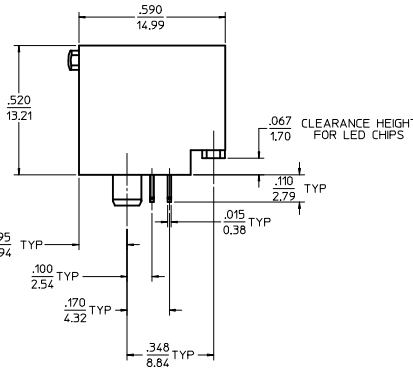
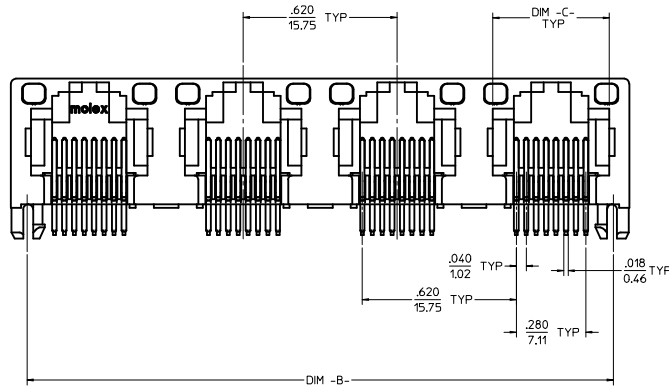
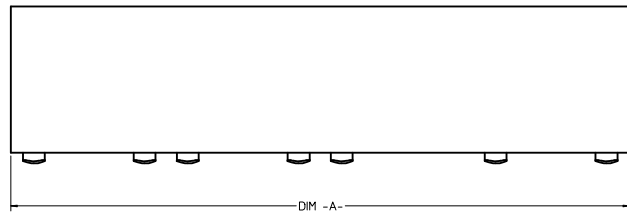

8 CIRCUIT HOUSING(S)

ASSEMBLY MATERIAL NUMBER	NUMBER OF CIRCUITS	NUMBER OF PORTS	PEG STYLE	DIM -A-	DIM -B-	DIM -C-
44248-0001	8	2	SNAP-FIT	1.250/31.75	1.120/28.45	.469/11.92
44248-0002	8	4	SNAP-FIT	2.490/63.25	2.360/59.94	.469/11.92
44248-0005	8	2	PRESS-FIT	1.250/31.75	1.120/28.45	.469/11.92
44248-0006	8	4	PRESS-FIT	2.490/63.25	2.360/59.94	.469/11.92

6 CIRCUIT HOUSING(S)

ASSEMBLY MATERIAL NUMBER	NUMBER OF CIRCUITS	NUMBER OF PORTS	PEG STYLE	DIM -A-	DIM -B-	DIM -C-
44248-0009	6	2	SNAP-FIT	1.250/31.75	1.120/28.45	.389/9.88
44248-0010	4	2	SNAP-FIT	1.250/31.75	1.120/28.45	.389/9.88
44248-0011	6	4	SNAP-FIT	2.490/63.25	2.360/59.94	.389/9.88
44248-0012	4	4	SNAP-FIT	2.490/63.25	2.360/59.94	.389/9.88
44248-0017	6	2	PRESS-FIT	1.250/31.75	1.120/28.45	.389/9.88
44248-0018	4	2	PRESS-FIT	1.250/31.75	1.120/28.45	.389/9.88
44248-0019	6	4	PRESS-FIT	2.490/63.25	2.360/59.94	.389/9.88
44248-0020	4	4	PRESS-FIT	2.490/63.25	2.360/59.94	.389/9.88

- NOTES:**
- MATERIAL:
HOUSING: POLYESTER(PBT), GLASS FILLED, UL94V-0, COLOR: BLACK
LIGHT PIPES: POLYCARBONATE, UL-94V2, COLOR: CLEAR
TERMINALS: PHOSPHOR BRONZE
 - FINISH:
TERMINALS:
*SELECT GOLD IN CONTACT AREA: 50 MICRONCHES (127 MICROMETERS) MIN.
*SELECT TIN IN PC TAIL AREA: 100 MICRONCHES (2.54 MICROMETERS) MIN.
WITH OVERALL NICKEL UNDERPLATE: 50 MICRONCHES (1.27 MICROMETERS) MIN.
*THE PRIMARY SHIPPING CARTON WILL BE LABELED "COMPLIANT TO RoHS DIRECTIVE 2002/95/EC AND ELV ANNEX II OF DIRECTIVE 2000/53/EC."
CARTONS WITHOUT THIS LABEL MAY CONTAIN PRODUCT WITH TIN-LEAD IN THE PC TAILS.
 - PRODUCT SPECIFICATION AND PROCESSING PARAMETERS: PS-43860-003.
SPECIFICATION PK-44248-004.
 - PACKAGING SPECIFICATION:
CONNECTOR ASSEMBLIES IN THERMOFORMED TRAYS PER MOLEX PACKAGING
 - APPLICATION SPECIFICATION: AS-43860-001
 - ALL UNTOLERANCED DIMENSIONS ARE SHOWN FOR REFERENCE ONLY.
 - CONFORMS TO FCC REGULATION PART 68.5 FOR MODULAR JACKS.
 - MODJACKS AVAILABLE WITH EITHER SNAP-FIT OR PRESS-FIT PEGS.
THIS DRAWING SHOWS SNAP-FIT PEGS.
 - PCB LAYOUT AND PANEL CUT-OUT SHOWN ON SHEETS (5) AND (6).
 - THIS PART CONFORMS TO CLASS B REQUIREMENTS OF COSMETIC SPECIFICATION PS-45499-002.

UNSHIELDED
WITH LIGHT PIPES

CHGD 0117 TO 0119 IEC NO: UCP2009-1482 DRAWN: KLOSTNER 2008/12/10 CHKD: BELL 2008/12/10 APPROVED: SMITH 2008/12/10 REV 4	QUALITY SYMBOLS ▽=0 ▽=0	GENERAL TOLERANCES (UNLESS SPECIFIED): <table border="1"> <thead> <tr> <th></th> <th>mm</th> <th>INCH</th> </tr> </thead> <tbody> <tr> <td>4 PLACES</td> <td>±.010</td> <td>±.0004</td> </tr> <tr> <td>3 PLACES</td> <td>±.015</td> <td>±.0006</td> </tr> <tr> <td>2 PLACES</td> <td>±.025</td> <td>±.0010</td> </tr> <tr> <td>1 PLACE</td> <td>±.050</td> <td>±.0020</td> </tr> </tbody> </table> ANGULAR ±1/2°		mm	INCH	4 PLACES	±.010	±.0004	3 PLACES	±.015	±.0006	2 PLACES	±.025	±.0010	1 PLACE	±.050	±.0020	DIMENSION STYLE IN/MM	SCALE 4:1	DESIGN UNITS INCH	THIRD ANGLE PROJECTION
		mm	INCH																		
	4 PLACES	±.010	±.0004																		
	3 PLACES	±.015	±.0006																		
2 PLACES	±.025	±.0010																			
1 PLACE	±.050	±.0020																			
DRAWN BY: MMAYO CHECKED BY: JROBERTS APPROVED BY: JROBERTS	DATE: 98/10/06 DATE: 98/10/06 DATE: 98/10/06	TITLE GANGED INVERTED MODJACK ASSEMBLY	MOLEX INCORPORATED																		
DRAFT WHERE APPLICABLE MUST REMAIN WITHIN DIMENSIONS		MATERIAL NO. SEE CHART	DOCUMENT NO. SD-44248-001	SHEET NO. 1 OF 6	THIS DRAWING CONTAINS INFORMATION THAT IS PROPRIETARY TO MOLEX INCORPORATED AND SHOULD NOT BE USED WITHOUT WRITTEN PERMISSION																

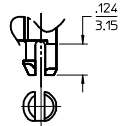

(SNAP-FIT PEG OPTION)

SCALE: NTS.
SEE NOTE #8

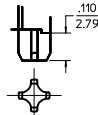

(PRESS-FIT PEG OPTION)

SCALE: NTS.
SEE NOTE #8

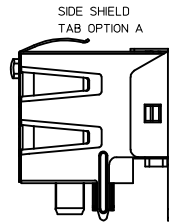

SIDE SHIELD
TAB OPTION A

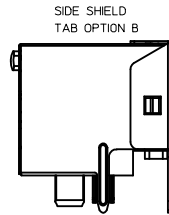

SIDE SHIELD
TAB OPTION B

(8) CIRCUIT HOUSING(S)							
ASSEMBLY MATERIAL NUMBER	NUMBER OF CIRCUITS	NUMBER OF PORTS	PEG STYLE	SIDE SHIELD TAB OPTION	DIM -A-	DIM -B-	DIM -C-
44248-0029	8	2	SNAP-FIT	A	1.274/32.36	1.120/28.45	.469/11.92
44248-0030	8	4	SNAP-FIT	A	2.514/63.86	2.360/59.94	.469/11.92
44248-0033	8	2	PRESS-FIT	A	1.274/32.36	1.120/28.45	.469/11.92
44248-0034	8	4	PRESS-FIT	A	2.514/63.86	2.360/59.94	.469/11.92

(6) CIRCUIT HOUSING(S)							
ASSEMBLY MATERIAL NUMBER	NUMBER OF CIRCUITS	NUMBER OF PORTS	PEG STYLE	SIDE SHIELD TAB OPTION	DIM -A-	DIM -B-	DIM -C-
44248-0037	6	2	SNAP-FIT	A	1.274/32.36	1.120/28.45	.389/9.88
44248-0038	4	2	SNAP-FIT	A	1.274/32.36	1.120/28.45	.389/9.88
44248-0039	6	4	SNAP-FIT	A	2.514/63.86	2.360/59.94	.389/9.88
44248-0040	4	4	SNAP-FIT	A	2.514/63.86	2.360/59.94	.389/9.88
44248-0045	6	2	PRESS-FIT	A	1.274/32.36	1.120/28.45	.389/9.88
44248-0046	4	2	PRESS-FIT	A	1.274/32.36	1.120/28.45	.389/9.88
44248-0047	6	4	PRESS-FIT	A	2.514/63.86	2.360/59.94	.389/9.88
44248-0048	4	4	PRESS-FIT	A	2.514/63.86	2.360/59.94	.389/9.88

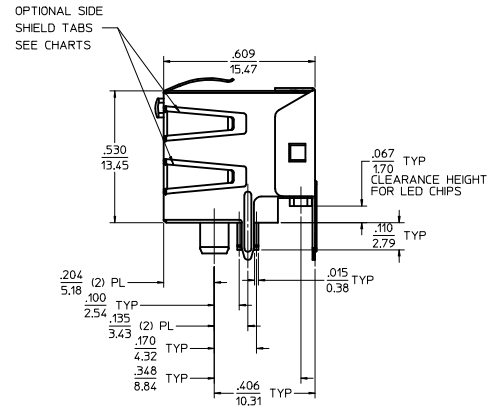
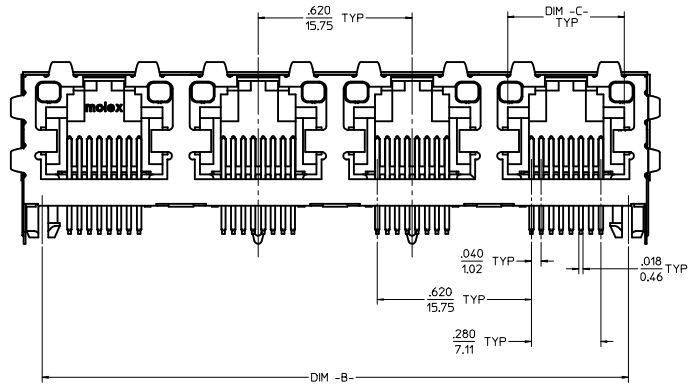
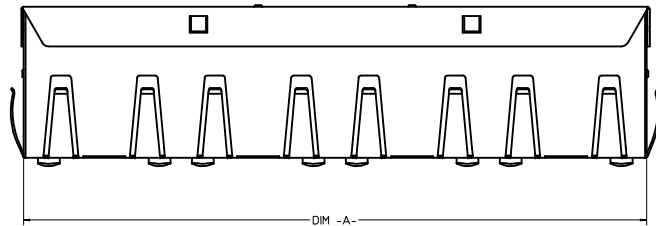

OPTIONAL SIDE SHIELD TABS SEE CHARTS

- NOTES:
- MATERIAL: HOUSING: POLYESTER(PBT), GLASS FILLED, UL94V-0, COLOR: BLACK
LIGHT PIPES: POLYCARBONATE, UL-94V2, COLOR: CLEAR
TERMINALS: PHOSPHOR BRONZE
SHIELD: BRASS
 - FINISH: TERMINALS:
*SELECT GOLD IN CONTACT AREA: 50 MICROINCHES (1.27 MICROMETERS) MIN.
*SELECT TIN IN PC TAIL AREA: 100 MICROINCHES (2.54 MICROMETERS) MIN., WITH OVERALL NICKEL UNDERPLATE: 50 MICROINCHES (1.27 MICROMETERS) MIN.
SHIELD:
*100 MICROINCHES (2.54 MICROMETERS) NICKEL OVER 50 MICROINCHES (1.27 MICROMETERS) COPPER UNDERPLATE PCB GROUND TABS DIPPED IN TIN
*THE PRIMARY SHIPPING CARTON WILL BE LABELED "COMPLIANT TO RoHS DIRECTIVE 2002/95/EC AND ELV ANNEX II OF DIRECTIVE 2000/53/EC". CARTONS WITHOUT THIS LABEL MAY CONTAIN PRODUCT WITH TIN-LEAD IN THE PC TAILS AND/OR SHIELD.
 - PRODUCT SPECIFICATION AND PROCESSING PARAMETERS: PS-43860-003.
 - PACKAGING SPECIFICATION: CONNECTOR ASSEMBLIES IN THERMOFORMED TRAYS PER MOLEX PACKAGING SPECIFICATION PK-44248-004.
 - APPLICATION SPECIFICATION: AS-43860-001
 - ALL UNTOLERANCED DIMENSIONS ARE SHOWN FOR REFERENCE ONLY.
 - CONFORMS TO FCC REGULATION PART 68.5 FOR MODULAR JACKS.
 - MODJACKS AVAILABLE WITH EITHER SNAP-FIT OR PRESS-FIT PEGS. THIS DRAWING SHOWS SNAP-FIT PEGS.
 - PCB LAYOUT AND PANEL CUT-OUT SHOWN ON SHEETS (5) AND (6).
 - THIS PART CONFORMS TO CLASS B REQUIREMENTS OF COSMETIC SPECIFICATION PS-45499-002.

SHIELDED WITH LIGHT PIPES

SEE SHEET 1 IEC NO: UCP2009-1482 DRAWN: KLOSTNER/ER 2008/12/10 CHKD: BELL 2008/12/10 APPROVED: SMITH 2008/12/10 REV DESCRIPTION	QUALITY SYMBOLS	GENERAL TOLERANCES (UNLESS SPECIFIED)	DIMENSION STYLE	SCALE	DESIGN UNITS	THIRD ANGLE PROJECTION
	$\nabla=0$ $\nabla=0$	± mm ± INCH 4 PLACES ± --- ± --- 3 PLACES ± --- ± .010 2 PLACES ± 0.25 ± --- 1 PLACE ± --- ± --- ANGULAR ±1/2°	IN/MM DRAWN BY DATE M MAYO 98/10/06 CHECKED BY DATE J ROBERTS 98/10/06 APPROVED BY DATE J ROBERTS 98/10/06	4:1	INCH	TITLE GANGED INVERTED MODJACK ASSEMBLY
	DRAFT WHERE APPLICABLE MUST REMAIN WITHIN DIMENSIONS	MATERIAL NO. SEE CHART SIZE D THIS DRAWING CONTAINS INFORMATION THAT IS PROPRIETARY TO MOLEX INCORPORATED AND SHOULD NOT BE USED WITHOUT WRITTEN PERMISSION	MOLEX INCORPORATED DOCUMENT NO. SD-44248-001	SHEET NO. 2 OF 6		

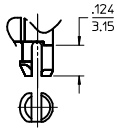

SNAP-FIT PEG OPTION
SCALE: NTS,
SEE NOTE #7

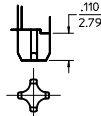

PRESS-FIT PEG OPTION
SCALE: NTS,
SEE NOTE #7

8 CIRCUIT HOUSING(S)						
ASSEMBLY MATERIAL NUMBER	NUMBER OF CIRCUITS	NUMBER OF PORTS	PEG STYLE	DIM -A-	DIM -B-	DIM -C-
44248-0057	8	2	SNAP-FIT	1.250/31.75	1.120/28.45	.469/11.92
44248-0058	8	4	SNAP-FIT	2.490/63.25	2.360/59.94	.469/11.92
44248-0061	8	2	PRESS-FIT	1.250/31.75	1.120/28.45	.469/11.92
44248-0062	8	4	PRESS-FIT	2.490/63.25	2.360/59.94	.469/11.92

6 CIRCUIT HOUSING(S)						
ASSEMBLY MATERIAL NUMBER	NUMBER OF CIRCUITS	NUMBER OF PORTS	PEG STYLE	DIM -A-	DIM -B-	DIM -C-
44248-0065	6	2	SNAP-FIT	1.250/31.75	1.120/28.45	.389/9.88
44248-0066	4	2	SNAP-FIT	1.250/31.75	1.120/28.45	.389/9.88
44248-0067	6	4	SNAP-FIT	2.490/63.25	2.360/59.94	.389/9.88
44248-0068	4	4	SNAP-FIT	2.490/63.25	2.360/59.94	.389/9.88
44248-0073	6	2	PRESS-FIT	1.250/31.75	1.120/28.45	.389/9.88
44248-0074	4	2	PRESS-FIT	1.250/31.75	1.120/28.45	.389/9.88
44248-0075	6	4	PRESS-FIT	2.490/63.25	2.360/59.94	.389/9.88
44248-0076	4	4	PRESS-FIT	2.490/63.25	2.360/59.94	.389/9.88

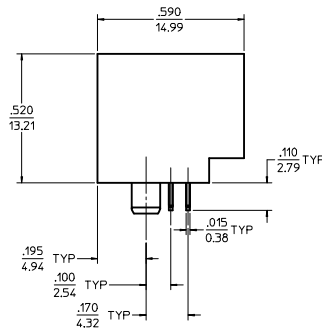
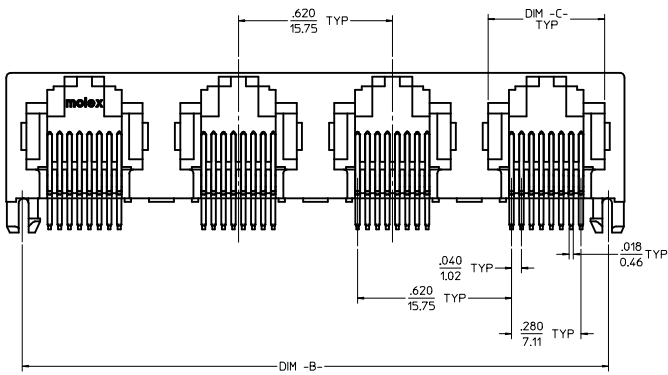

- NOTES:
 1) MATERIAL:
 HOUSING: POLYESTER(PBT), GLASS FILLED, UL94V-0, COLOR: BLACK
 TERMINALS: PHOSPHOR BRONZE
 2) FINISH:
 TERMINALS:
 *SELECT GOLD IN CONTACT AREA: 50 MICROINCHES (1.27 MICROMETERS) MIN.
 *SELECT TIN IN PC TAIL AREA: 100 MICROINCHES (2.54 MICROMETERS) MIN.
 WITH OVERALL NICKEL UNDERPLATE: 50 MICROINCHES (1.27 MICROMETERS) MIN.
 *THE PRIMARY SHIPPING CARTON WILL BE LABELED "COMPLIANT TO RoHS DIRECTIVE 2002/95/EC AND ELV ANNEX II OF DIRECTIVE 2000/53/EC". CARTONS WITHOUT THIS LABEL MAY CONTAIN PRODUCT WITH TIN-LEAD IN THE PC TAILS.
 3) PRODUCT SPECIFICATION AND PROCESSING PARAMETERS: PS-43860-003.
 4) PACKAGING SPECIFICATION:
 CONNECTOR ASSEMBLIES IN THERMOFORMED TRAYS PER MOLEX PACKAGING SPECIFICATION PK-44248-004.
 5) ALL UNTOLERANCED DIMENSIONS ARE SHOWN FOR REFERENCE ONLY.
 6) CONFORMS TO FCC REGULATION PART 68.5 FOR MODULAR JACKS.
 7) MODJACKS AVAILABLE WITH EITHER SNAP-FIT OR PRESS-FIT PEGS. THIS DRAWING SHOWS SNAP-FIT PEGS.
 8) PCB LAYOUT AND PANEL CUT-OUT SHOWN ON SHEETS (5) AND (6).
 9) THIS PART CONFORMS TO CLASS B REQUIREMENTS OF COSMETIC SPECIFICATION PS-45499-002.

UNSHIELDED

SEE SHEET 1 IEC NO: UCP2009-1482 DRAWN: KLOSTNER 2008/12/10 CHKD: BELL 2008/12/10 APPROVED: SMITH 2008/12/10	QUALITY SYMBOLS	GENERAL TOLERANCES (UNLESS SPECIFIED)	DIMENSION STYLE	SCALE	DESIGN UNITS	THIRD ANGLE PROJECTION
	▽=0 ▽=0	mm INCH 4 PLACES ± .--- ± .--- 3 PLACES ± .--- ± .010 2 PLACES ± 0.25 ± .--- 1 PLACE ± .--- ± .--- ANGULAR ±1/2°	IN/MM DRAWN BY: MMAYO DATE: 98/10/06 CHECKED BY: JROBERTS DATE: 98/10/06 APPROVED BY: JROBERTS DATE: 98/10/06	4:1	INCH	GANGED INVERTED MODJACK ASSEMBLY
	DRAFT WHERE APPLICABLE MUST REMAIN WITHIN DIMENSIONS	SEE CHART	MATERIAL NO.	DOCUMENT NO.	MOLEX INCORPORATED SD-44248-001	
		SIZE D	THIS DRAWING CONTAINS INFORMATION THAT IS PROPRIETARY TO MOLEX INCORPORATED AND SHOULD NOT BE USED WITHOUT WRITTEN PERMISSION		SHEET NO. 3 OF 6	

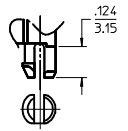

SNAP-FIT PEG OPTION

SCALE: NTS
SEE NOTE #7

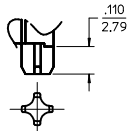

PRESS-FIT PEG OPTION

SCALE: NTS
SEE NOTE #7

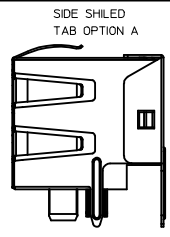

SIDE SHIELDED
TAB OPTION A

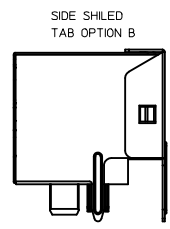

SIDE SHIELDED
TAB OPTION B

(8) CIRCUIT HOUSING(S)								
X = NOT TOOLED	ASSEMBLY MATERIAL NUMBER	NUMBER OF CIRCUITS	NUMBER OF PORTS	PEG STYLE	SIDE SHIELD TAB OPTION	DIM -A-	DIM -B-	DIM -C-
	44248-0085	8	2	SNAP-FIT	A	1.274/32.36	1.120/28.45	.469/11.92
	44248-0086	8	4	SNAP-FIT	A	2.514/63.86	2.360/59.94	.469/11.92
	44248-0089	8	2	PRESS-FIT	A	1.274/32.36	1.120/28.45	.469/11.92
	44248-0090	8	4	PRESS-FIT	A	2.514/63.86	2.360/59.94	.469/11.92
X	44248-0119	8	4	PRESS FIT	B	2.514/63.86	2.360/59.94	.469/11.92

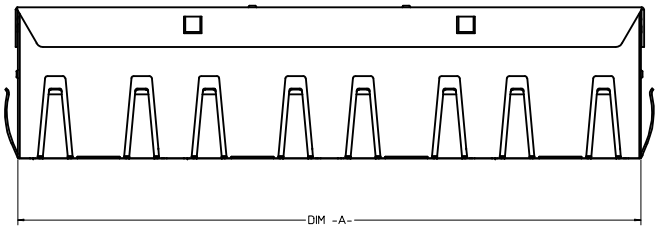

(6) CIRCUIT HOUSING(S)								
ASSEMBLY MATERIAL NUMBER	NUMBER OF CIRCUITS	NUMBER OF PORTS	PEG STYLE	SIDE SHIELD TAB OPTION	DIM -A-	DIM -B-	DIM -C-	
44248-0093	6	2	SNAP-FIT	A	1.274/32.36	1.120/28.45	.389/9.88	
44248-0094	4	2	SNAP-FIT	A	1.274/32.36	1.120/28.45	.389/9.88	
44248-0095	6	4	SNAP-FIT	A	2.514/63.86	2.360/59.94	.389/9.88	
44248-0096	4	4	SNAP-FIT	A	2.514/63.86	2.360/59.94	.389/9.88	
44248-0101	6	2	PRESS-FIT	A	1.274/32.36	1.120/28.45	.389/9.88	
44248-0102	4	2	PRESS-FIT	A	1.274/32.36	1.120/28.45	.389/9.88	
44248-0103	6	4	PRESS-FIT	A	2.514/63.86	2.360/59.94	.389/9.88	
44248-0104	4	4	PRESS-FIT	A	2.514/63.86	2.360/59.94	.389/9.88	

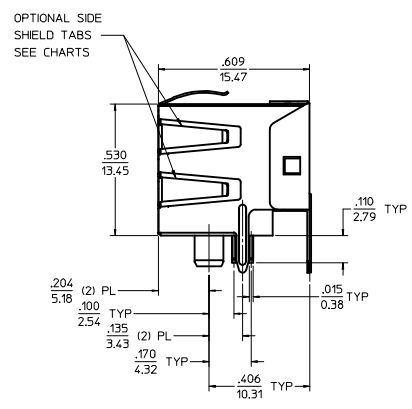
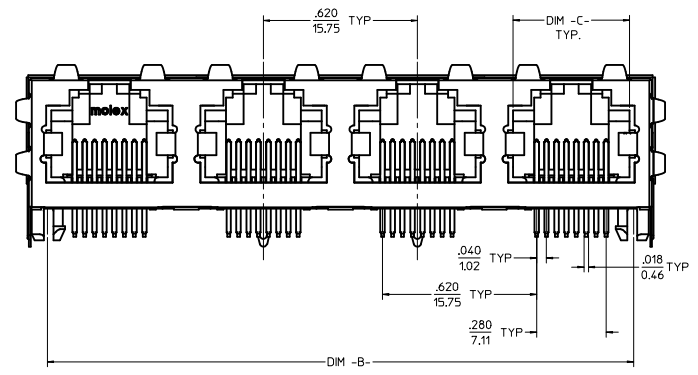

- NOTES:
- MATERIAL:
HOUSING: POLYESTER(PBT), GLASS FILLED, UL94V-0, COLOR: BLACK
TERMINALS: PHOSPHOR BRONZE
SHIELD: BRASS
 - FINISH:
TERMINALS:
*SELECT GOLD IN CONTACT AREA: 50 MICRONCHES (1.27 MICROMETERS) MIN.
*SELECT TIN IN PC-TAIL AREA: 100 MICRONCHES (2.54 MICROMETERS) MIN.
WITH OVERALL NICKEL UNDERPLATE: 50 MICRONCHES (1.27 MICROMETERS) MIN.
SHIELD:
*100 MICRONCHES (2.54 MICROMETERS) NICKEL OVER 50 MICRONCHES (1.27 MICROMETERS) COPPER UNDERPLATE PCB GROUND TABS DIPPED IN TIN
*THE PRIMARY SHIPPING CARTON WILL BE LABELED "COMPLIANT TO RoHS DIRECTIVE 2002/95/EC AND ELV ANNEX II OF DIRECTIVE 2000/53/EC"
CARTONS WITHOUT THIS LABEL MAY CONTAIN PRODUCT WITH TIN-LEAD IN THE PC TAILS AND/OR SHIELD.
 - PRODUCT SPECIFICATION AND PROCESSING PARAMETERS: PS-43860-003.
 - PACKAGING SPECIFICATION:
CONNECTOR ASSEMBLIES IN THERMOFORMED TRAYS PER MOLEX PACKAGING SPECIFICATION PK-44248-004.
 - ALL UNTOLERANCED DIMENSIONS ARE SHOWN FOR REFERENCE ONLY.
 - CONFORMS TO FCC REGULATION PART 68.5 FOR MODULAR JACKS.
 - MODJACKS AVAILABLE WITH EITHER SNAP-FIT OR PRESS-FIT PEGS.
THIS DRAWING SHOWS SNAP-FIT PEGS.
 - PCB LAYOUT AND PANEL CUT-OUT SHOWN ON SHEETS (5) AND (6).
 - THIS PART CONFORMS TO CLASS B REQUIREMENTS OF COSMETIC SPECIFICATION PS-43499-002.

SHIELDED

CHGD 0117 TO 0119 IEC NO: UCP2009-1482 DRAWN: KLOS/TEHLER 2008/12/10 CHKD: BELL 2008/12/10 APPROV: SMITH 2008/12/10 REV: C4	QUALITY SYMBOLS ▽=0 ▽=0	GENERAL TOLERANCES (UNLESS SPECIFIED) <table border="1"> <tr> <th></th> <th>mm</th> <th>INCH</th> </tr> <tr> <td>4 PLACES ±</td> <td>---</td> <td>±.010</td> </tr> <tr> <td>3 PLACES ±</td> <td>---</td> <td>±.025</td> </tr> <tr> <td>2 PLACES ±</td> <td>0.25</td> <td>---</td> </tr> <tr> <td>1 PLACE ±</td> <td>---</td> <td>---</td> </tr> </table> ANGULAR ±1/2°		mm	INCH	4 PLACES ±	---	±.010	3 PLACES ±	---	±.025	2 PLACES ±	0.25	---	1 PLACE ±	---	---	DIMENSION STYLE IN/MM SCALE 4:1 DESIGN UNITS INCH THIRD ANGLE PROJECTION	DRAWN BY MMAYO DATE 98/10/06 CHECKED BY JROBERTS DATE 98/10/06 APPROVED BY JROBERTS DATE 98/10/06	TITLE GANGED INVERTED MODJACK ASSEMBLY MOLEX INCORPORATED MATERIAL NO. SD-44248-001 DOCUMENT NO. 4 OF 6 SHEET NO.
		mm	INCH																	
	4 PLACES ±	---	±.010																	
	3 PLACES ±	---	±.025																	
2 PLACES ±	0.25	---																		
1 PLACE ±	---	---																		
DRAFT WHERE APPLICABLE MUST REMAIN WITHIN DIMENSIONS																				
SEE CHART																				
THIS DRAWING CONTAINS INFORMATION THAT IS PROPRIETARY TO MOLEX INCORPORATED AND SHOULD NOT BE USED WITHOUT WRITTEN PERMISSION																				

