

M54563WP

8-UNIT 500mA SOURCE TYPE DARLINGTON TRANSISTOR ARRAY WITH CLAMP DIODE

DESCRIPTION

M54563WP is eight-circuit output-sourcing darlington transistor array. The circuits are made of PNP and NPN transistors. This semiconductor integrated circuit performs high current driving with extremely low input-current supply.

FEATURES

- High breakdown voltage ($BV_{CEO} \geq 50V$)
- High-current driving ($I_o(max) = -500mA$)
- With clamping diodes
- Driving available with PMOS IC output of 6 ~ 16V or with TTL output
- Output current-sourcing type

APPLICATIONS

Drives of relays, printers, LEDs, fluorescent display tubes and lamps, and interfaces between MOS-bipolar logic systems and relays, solenoids, or small motors

FUNCTION

The M54563WP each have eight circuits, which are made of input inverters and current-sourcing outputs.

The outputs are made of PNP transistors and NPN Darlington transistors. The PNP transistor base current is constant. A clamping diode is provided between each output and GND. V_s and GND are used commonly among the eight circuits.

The inputs have resistance of $3k\Omega$, and voltage of up to 10V is applicable. Output current is 500 mA maximum. Supply voltage V_s is 50V maximum.

PIN CONFIGURATION

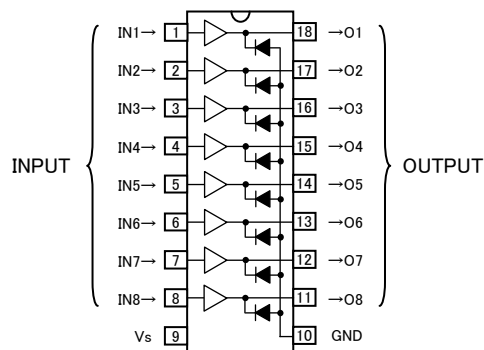

Package type 18P4X

CIRCUIT DIAGRAM

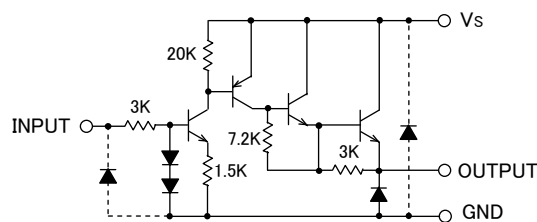

The eight circuits share the V_s and GND.
The diode, indicated with the dotted line, is parasitic, and cannot be used.

Unit: Ω

ABSOLUTE MAXIMUM RATINGS (Unless otherwise noted, $T_a = -20 \sim +75^\circ C$)

Symbol	Parameter	Conditions	Ratings	Unit
V_{CEO} #	Collector-emitter voltage	Output, L	-0.5 ~ +50	V
V_s	Supply voltage		50	V
V_i	Input voltage		-0.5 ~ +10	V
I_o	Output current	Current per circuit output, H	- 500	mA
I_F	Clamping diode forward current		- 500	mA
V_R #	Clamping diode reverse voltage		50	V
P_d	Power dissipation	$T_a = 25^\circ C$, when mounted on board	1.79	W
T_{opr}	Operating temperature		-20 ~ +75	$^\circ C$
T_{stg}	Storage temperature		-55 ~ +125	$^\circ C$

: Unused Input pins must be connected to GND.

8-UNIT 500mA SOURCE TYPE DARLINGTON TRANSISTOR ARRAY WITH CLAMP DIODE

RECOMMENDED OPERATING (Unless otherwise noted, Ta = -20 ~ +75°C)

Symbol	Parameter	Limits			Unit	
		min	typ	max		
Vs	Supply voltage	0	—	50	V	
Io	Output current (Current per 1 circuit when 8 circuits are coming on simultaneously)	Duty Cycle no more than 8%	0	—	-350	mA
		Duty Cycle no more than 55%	0	—	-100	
VIH	“H” input voltage	2.4	—	10	V	
VIL	“L” input voltage	0	—	0.2	V	

ELECTRICAL CHARACTERISTICS (Unless otherwise noted, Ta = -20 ~ +75°C)

Symbol	Parameter	Test conditions	Limits			Unit	
			min	typ*	max		
IS(leak) #	Supply leak current	Vs = 50V, VI = 0.2V	—	—	100	μA	
VCE(sat)	Collector-emitter saturation voltage	Vs = 10V, VI = 2.4V	Io = -350mA	—	1.6	2.4	V
			Io = -100mA	—	1.45	2.0	
Ii	Input current	VI = 3V	—	0.6	1.0	mA	
		VI = 10V	—	3.0	5.0		
IS	Supply current	Vs = 50V, VI = 3V(all input)	—	5.6	15.0	mA	
VF	Clamping diode forward voltage	IF = -350mA	—	-1.35	-2.4	V	
IR #	Clamping diode reverse current	VR = 50V	—	—	100	μA	

*: The typical values are those measured under ambient temperature (Ta) of 25°C. There is no guarantee that these values are obtained under any conditions.
 #: Unused Input pins must be connected to GND.

SWITCHING CHARACTERISTICS (Unless otherwise noted, Ta = 25°C)

Symbol	Parameter	Test conditions	Limits			Unit
			min	typ	max	
ton	Turn-on time	CL = 15pF (note 1)	—	100	—	ns
toff	Turn-off time		—	4800	—	ns

NOTE 1 TEST CIRCUIT

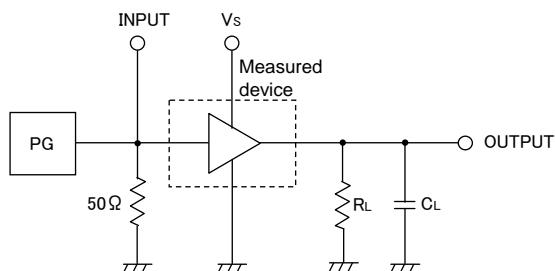

- (1) Pulse generator (PG) characteristics: PRR = 1kHz, tw = 10 μs, tr = 6ns, tf = 6ns, Zo = 50 Ω, VI = 0 to 2.4V
- (2) Input-output conditions : RL = 30 Ω, Vs = 10V
- (3) Electrostatic capacity CL includes floating capacitance at connections and input capacitance at probes

TIMING DIAGRAM

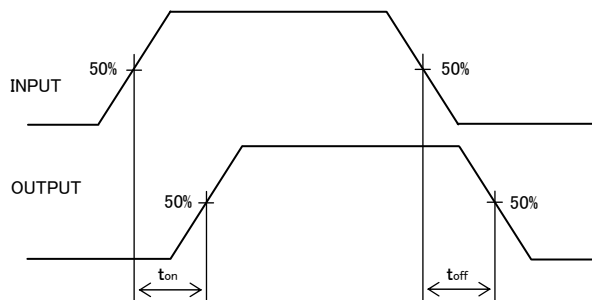

TYPICAL CHARACTERISTICS

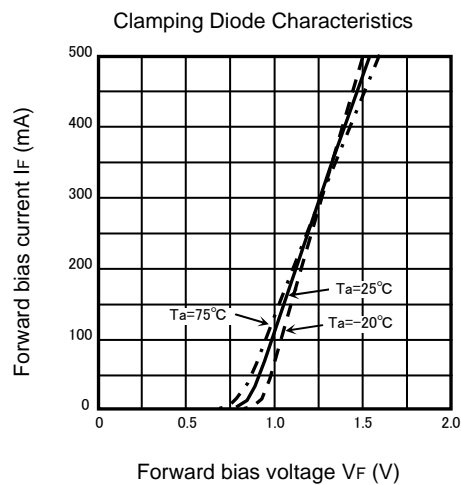
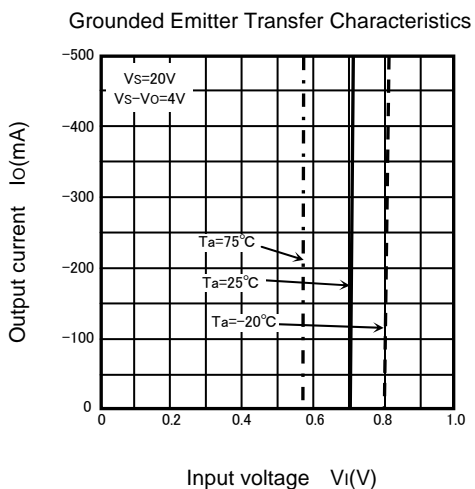
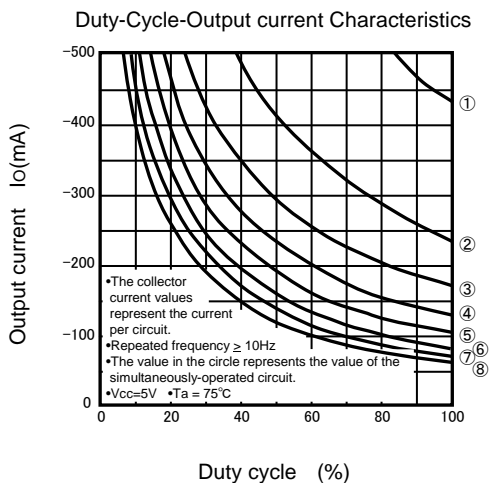
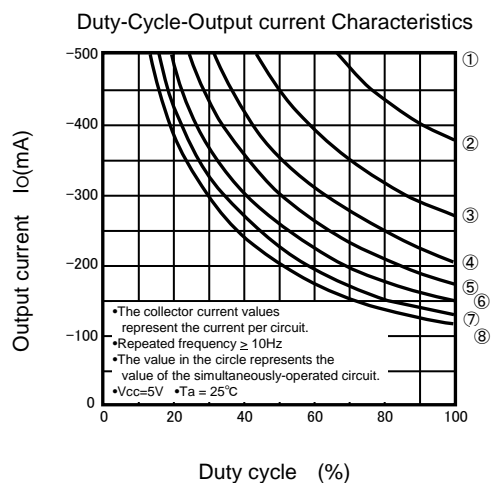
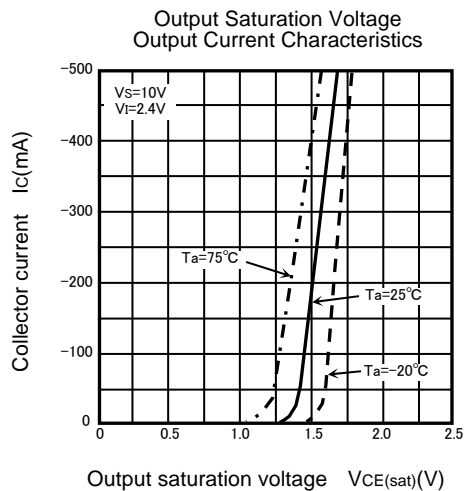
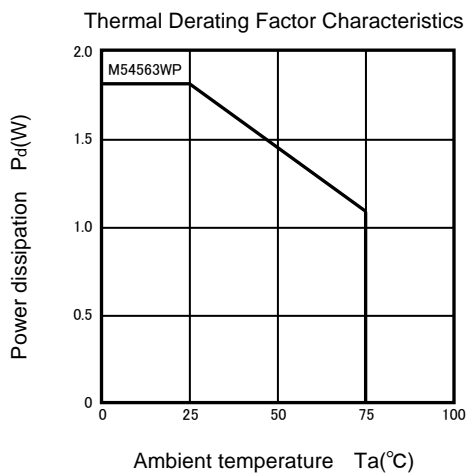

8-UNIT 500mA SOURCE TYPE DARLINGTON TRANSISTOR ARRAY WITH CLAMP DIODE

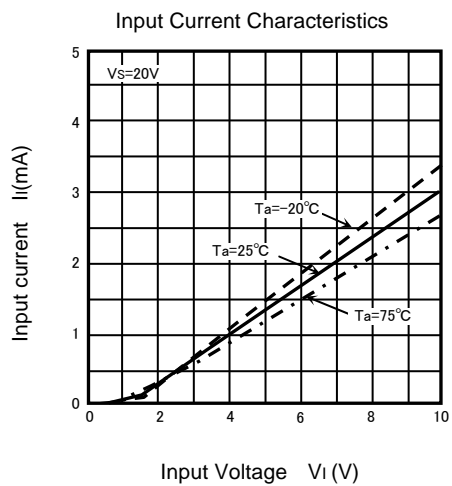
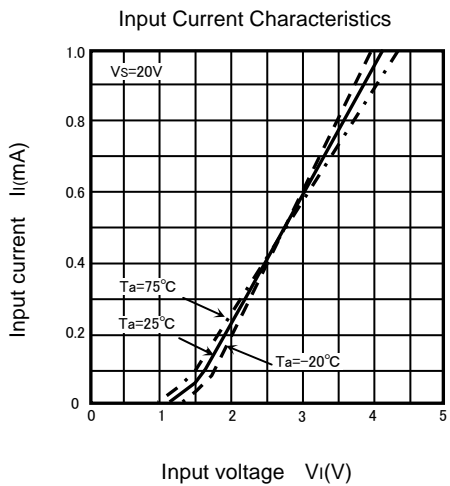

PACKAGE OUTLINE

18P4X

Plastic 18pin 300mil DIP

