

WIDEBAND POWER AMPLIFIER MODULE, 0.01 - 20 GHz



Features

- Gain: 12 dB
- P1dB Output Power: +28 dBm
- Regulated Supply and Bias Sequencing
- Hermetically Sealed Module
- Field Replaceable SMA connectors
- 0 to +85°C Operating Temperature

Typical Applications

The HMC-C057 Wideband PA is ideal for:

- Telecom Infrastructure
- Microwave Radio & VSAT
- Military & Space
- Test Instrumentation
- Fiber Optics

Functional Diagram

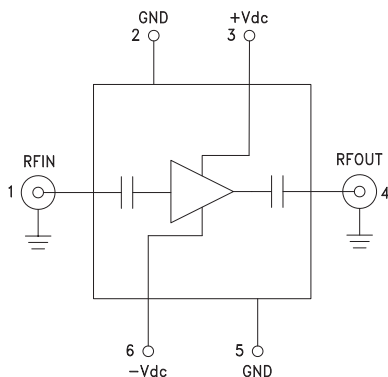

General Description

The HMC-C057 is a GaAs MMIC PHEMT Power Amplifier in a miniature, hermetic module with replaceable SMA connectors which operates between 0.01 GHz and 20 GHz. The amplifier provides 12 dB of gain, up to +36 dBm output IP3 and up to +28 dBm of output power at 1 dB gain compression. Gain flatness is excellent from 2 - 18 GHz making the HMC-C057 ideal for EW, ECM, Radar, Fiber Optic and test equipment applications. The wideband amplifier I/Os are internally matched to 50 Ohms and are DC blocked. Integrated voltage regulators allow for flexible biasing of both the negative and positive supply pins, while internal bias sequencing circuitry assures robust operation.

Electrical Specifications, $T_A = +25^\circ \text{C}$, $+V_{dc} = +11\text{V to } +16\text{V}$, $-V_{dc} = -3\text{V to } -12\text{V}$

Parameter	Min.	Typ.	Max.	Min.	Typ.	Max.	Min.	Typ.	Max.	Units
Frequency Range	0.5 - 6.0			6 - 12			12 - 20			GHz
Gain	9	12		9	12		8	11		dB
Gain Flatness		± 0.3			± 0.3			± 0.5		dB
Gain Variation Over Temperature		0.02			0.02			0.02		dB/°C
Noise Figure		4.5			3.5			5.0		dB
Input Return Loss		25			17			15		dB
Output Return Loss		20			17			12		dB
Output Power for 1 dB Compression (P1dB)	25	28		24	27		20	24		dBm
Saturated Output Power (Psat)		29			27.5			26		dBm
Output Third Order Intercept (IP3)		36			34			29		dBm
Positive Supply Current (+IDC)		345			345			345		mA
Negative Supply Current (-IDC)		-5			-5			-5		mA

WIDEBAND POWER AMPLIFIER MODULE, 0.01 - 20 GHz

Gain & Return Loss

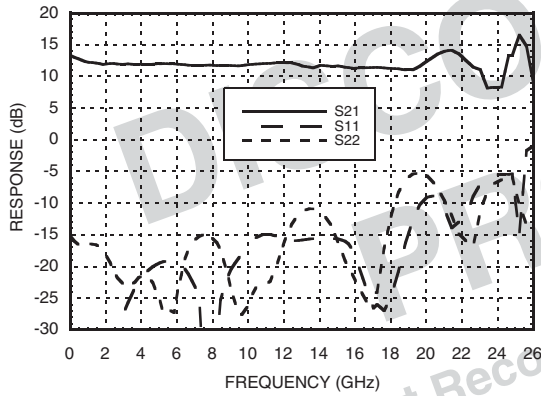

Gain vs. Temperature

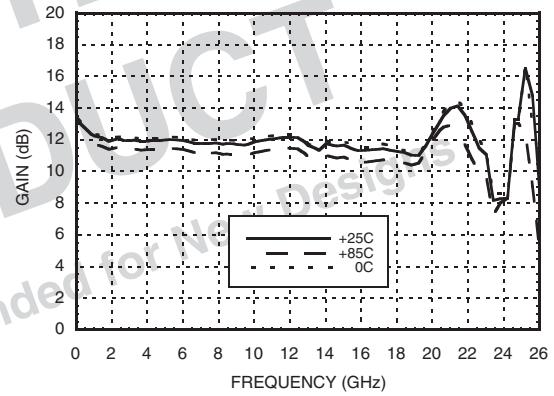

Input Return Loss vs. Temperature

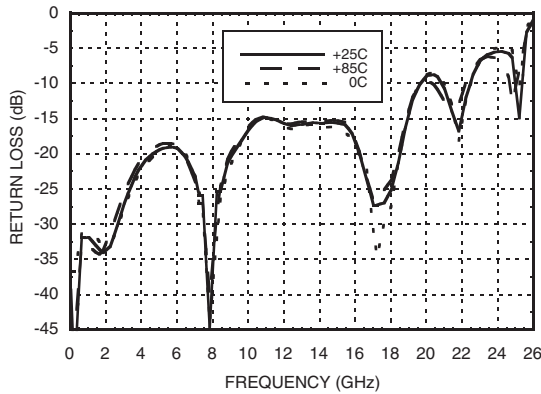

Output Return Loss vs. Temperature

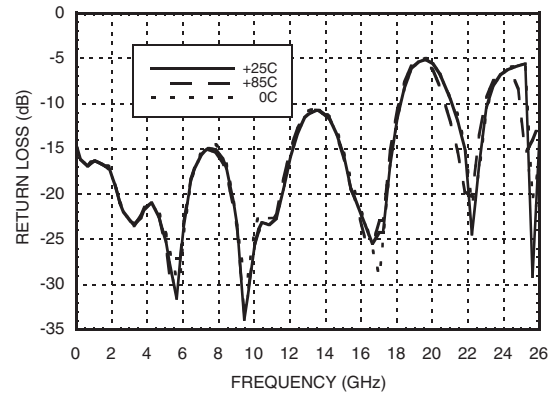

Reverse Isolation vs. Temperature

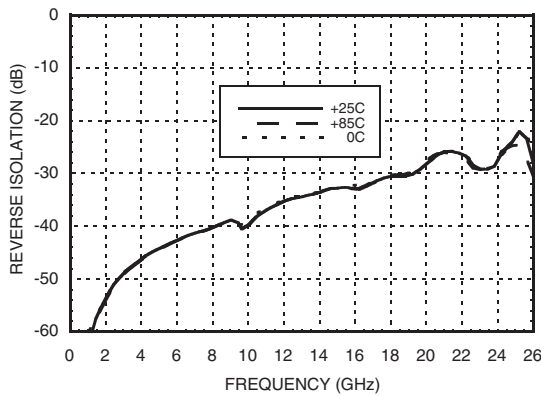

Noise Figure vs. Temperature

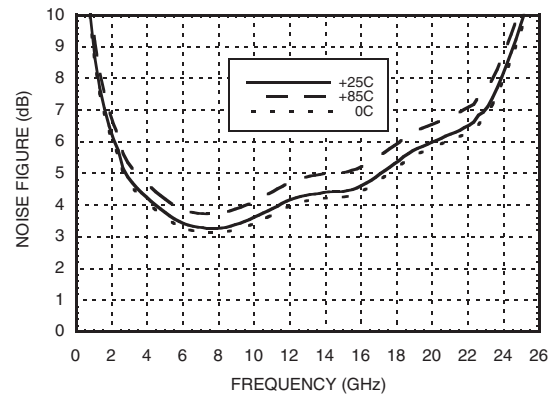



**WIDEBAND POWER AMPLIFIER
MODULE, 0.01 - 20 GHz**

P1dB vs. Temperature

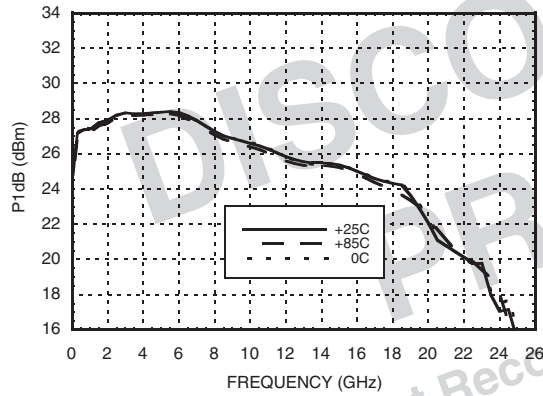

Psat vs. Temperature

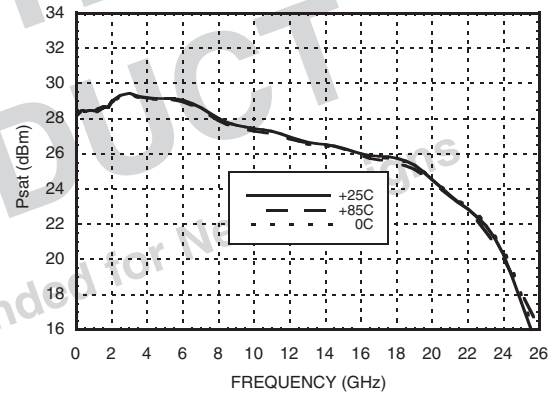

Output IP3 vs. Temperature

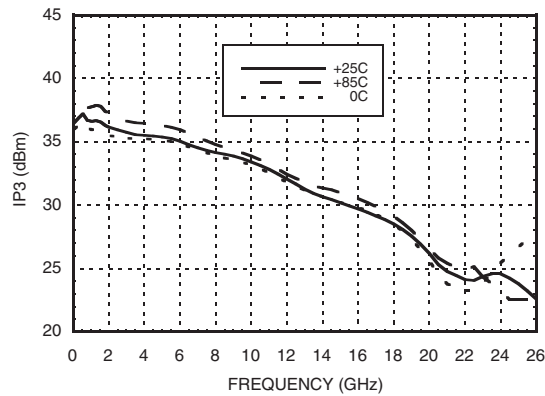





**WIDEBAND POWER AMPLIFIER
MODULE, 0.01 - 20 GHz**
Absolute Maximum Ratings

Positive Bias Supply Voltage (+Vdc)	+17V Max
Negative Bias Supply (-Vdc)	-16V Min.
Maximum RF Input Power	
Peak	24 dBm
CW @ 0.01 - 6 GHz	22 dBm
CW @ 6 - 12 GHz	21 dBm
CW @ 12 - 20 GHz	18 dBm
Storage Temperature	-65 to +150 °C
Operating Temperature	0 to +85 °C

**ELECTROSTATIC SENSITIVE DEVICE
OBSERVE HANDLING PRECAUTIONS**

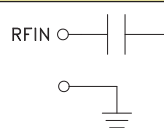
CONTINUED
 PRODUCT
 Not Recommended for New Designs

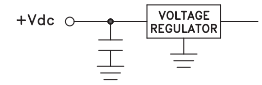
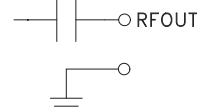
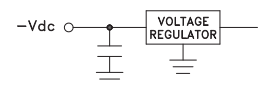
Pin Descriptions

Pin Number	Function	Description	Interface Schematic
1	RFIN & RF Ground	RF input connector, SMA female, field replaceable. This pin is AC coupled and matched to 50 Ohms.	
2, 5	GND	Power supply ground.	
3	+Vdc	Positive power supply voltage for the amplifier.	
4	RFOUT & RF Ground	RF output connector, SMA female. This pin is AC coupled and matched to 50 Ohms.	
6	-Vdc	Negative power supply voltage for the amplifier	



**WIDEBAND POWER AMPLIFIER
MODULE, 0.01 - 20 GHz**

Outline Drawing

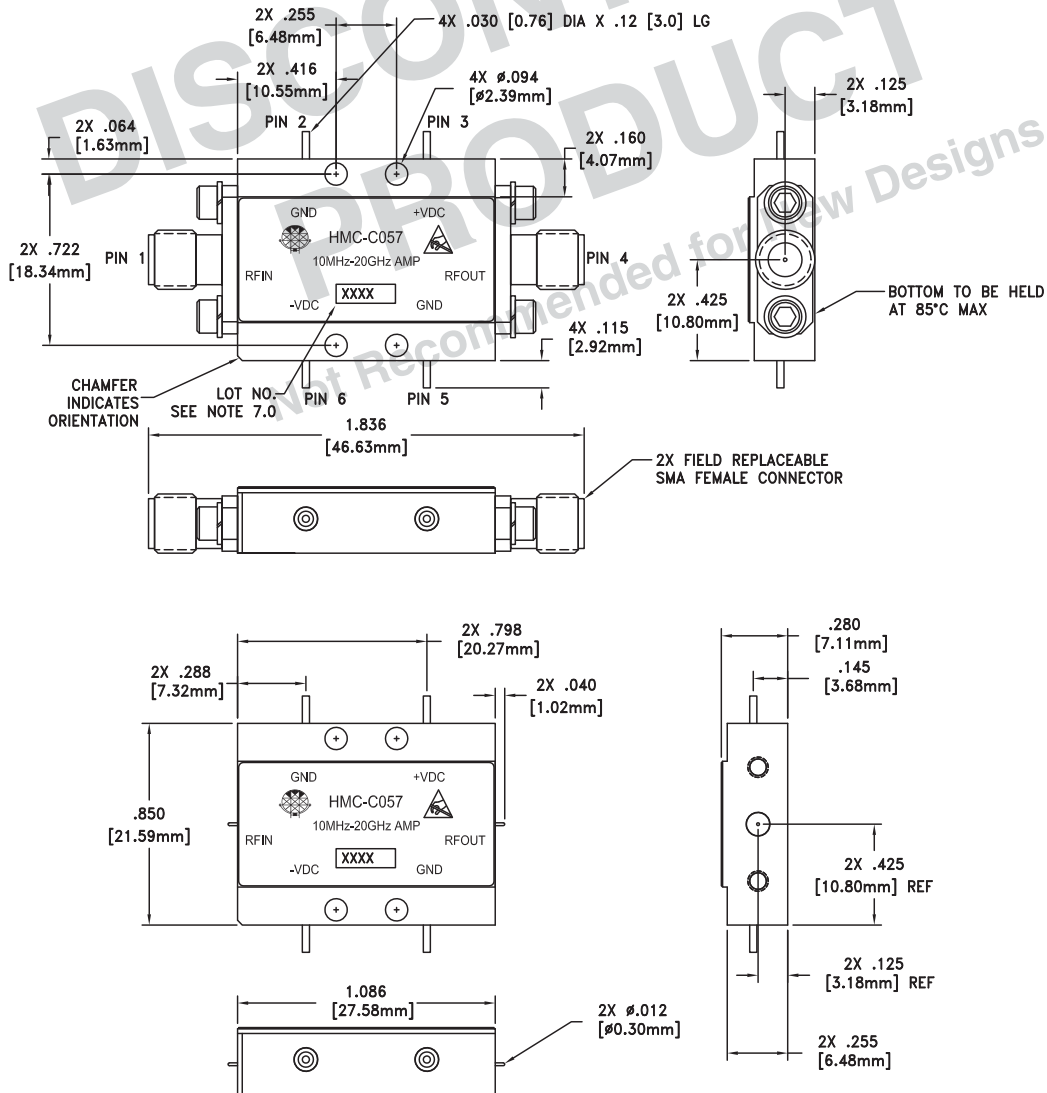

VIEW SHOWN WITH CONNECTORS REMOVED

Package Information

Package Type	C-10B
Package Weight [1]	23.1 gms [2]
Spacer Weight	N/A

[1] Includes the connectors

[2] \pm 1 gms Tolerance

NOTES:

1. PACKAGE, LEADS, COVER MATERIAL: KOVAR™
2. SPACER MATERIAL: ALUMINUM
3. PLATING: ELECTROLYTIC GOLD 50 MICROINCHES MIN., OVER ELECTROLYTIC NICKEL 75 MICROINCHES MIN.
4. ALL DIMENSIONS ARE IN INCHES [MILLIMETERS].
5. TOLERANCES \pm 0.010 [0.25] UNLESS OTHERWISE SPECIFIED.
6. FIELD REPLACEABLE SMA CONNECTORS. TENSOLITE 5602 - 5CCSF OR EQUIVALENT.



MICROWAVE CORPORATION v03.0709



HMC-C057

**WIDEBAND POWER AMPLIFIER
MODULE, 0.01 - 20 GHz**

Notes:

**DISCONTINUED
PRODUCT**
Not Recommended for New Designs