

Darlington

2SB1383

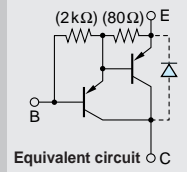

Equivalent circuit

Silicon PNP Epitaxial Planar Transistor (Complement to type 2SD2083)

Application : Chopper Regulator, DC Motor Driver and General Purpose

■ Absolute maximum ratings (Ta=25°C)

Symbol	Ratings	Unit
V _{CB0}	-120	V
V _{CEO}	-120	V
V _{EB0}	-6	V
I _C	-25(Pulse-40)	A
I _B	-2	A
P _C	120(T _C =25°C)	W
T _J	150	°C
T _{stg}	-55 to +150	°C

■ Electrical Characteristics (Ta=25°C)

Symbol	Conditions	Ratings	Unit
I _{CB0}	V _{CB} =-120V	-10max	μA
I _{EB0}	V _{EB} =-6V	-10max	mA
V(BR) _{CEO}	I _C =-25mA	-120min	V
h _{FE}	V _{CE} =-4V, I _C =-12A	2000min	
V _{CE(sat)}	I _C =-12A, I _B =-24mA	-1.8max	V
V _{BE(sat)}	I _C =-12A, I _B =-24mA	-2.5max	V
f _r	V _{CE} =-12V, I _E =1A	50typ	MHz
COB	V _{CB} =-10V, f=1MHz	230typ	pF

External Dimensions MT-100(TO3P)

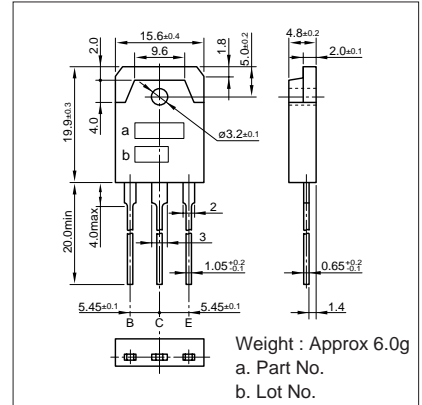

■ Typical Switching Characteristics (Common Emitter)

V _{CC} (V)	R _L (Ω)	I _C (A)	V _{BB1} (V)	V _{BB2} (V)	I _{B1} (mA)	I _{B2} (mA)	t _{on} (μs)	t _{stg} (μs)	t _f (μs)
-24	2	-12	-10	5	-24	24	1.0typ	3.0typ	1.0typ

I_C-V_{CE} Characteristics (Typical)

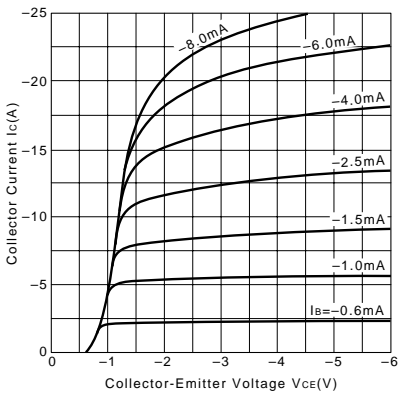

V_{CE(sat)}-I_B Characteristics (Typical)

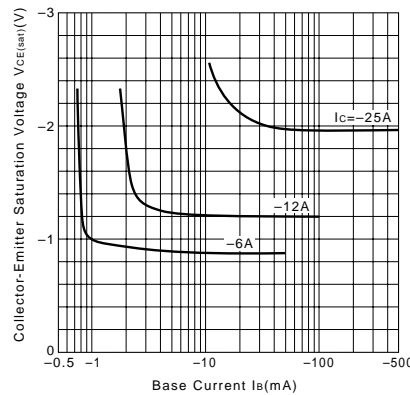

I_C-V_{BE} Temperature Characteristics (Typical)

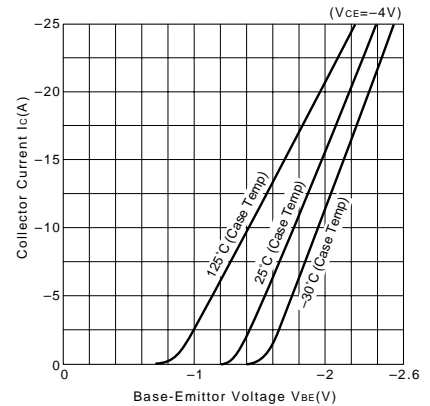

h_{FE}-I_C Characteristics (Typical)

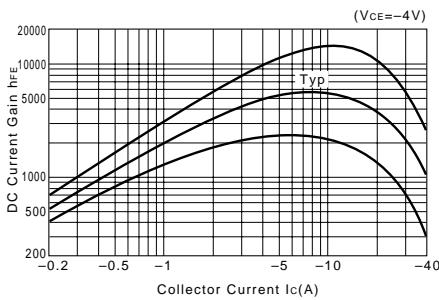

h_{FE}-I_C Temperature Characteristics (Typical)

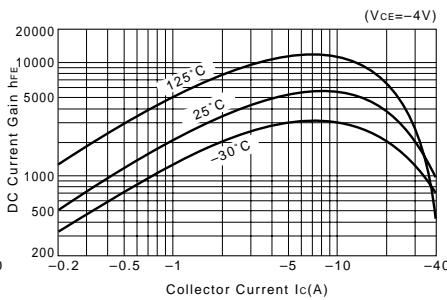

θ_{j-a}-t Characteristics

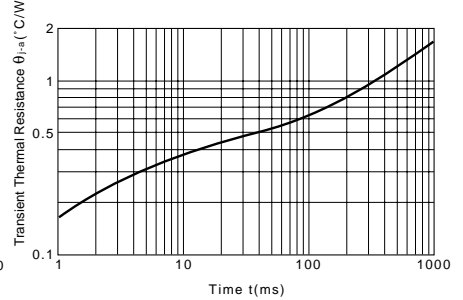

f_T-I_E Characteristics (Typical)

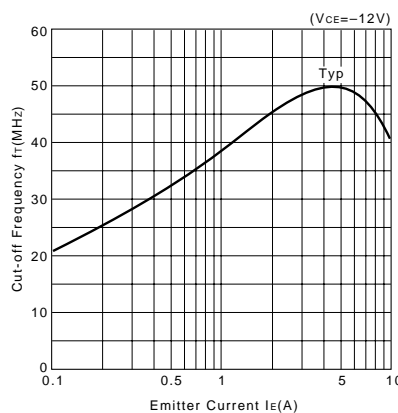

Safe Operating Area (Single Pulse)

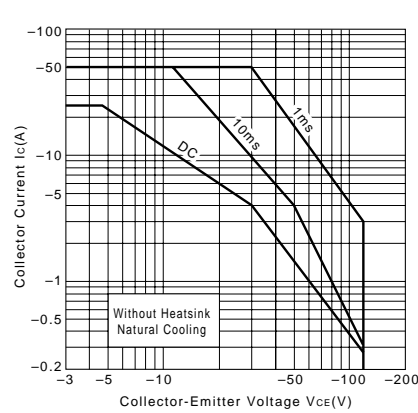

P_C-T_a Derating

