

SHINDENGEN

HVX-2 Series Power MOSFET

N-Channel Enhancement type

2SK2677
(FP10W90HVX2)

900V 10A

FEATURES

- Input capacitance (Ciss) is small. Especially, input capacitance at 0 bias is small.
- The static Rds(on) is small.
- The switching time is fast.
- Avalanche resistance guaranteed.

APPLICATION

- Switching power supply of AC 240V input
- High voltage power supply
- Inverter

OUTLINE DIMENSIONS

Case : ITO-3P

(Unit : mm)

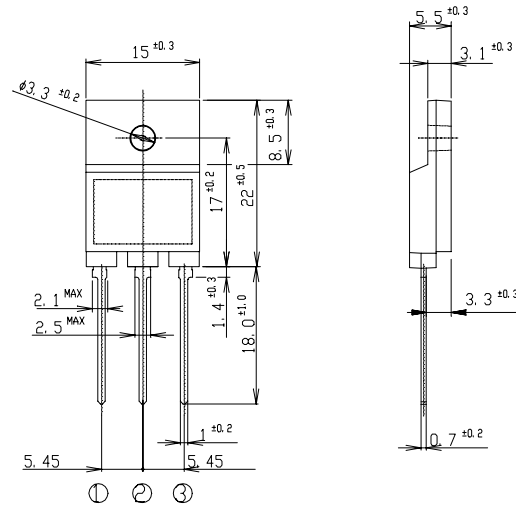

① : G
② : D
③ : S

RATINGS

- Absolute Maximum Ratings (Tc = 25°C)

| Item | Symbol | Conditions | Ratings | Unit |
|---------------------------------|------------------|---|---------|------|
| Storage Temperature | T _{stg} | | -55~150 | °C |
| Channel Temperature | T _{ch} | | 150 | |
| Drain-Source Voltage | V _{DSS} | | 900 | V |
| Gate-Source Voltage | V _{GSS} | | ±30 | |
| Continuous Drain Current (DC) | I _D | | 10 | A |
| Continuous Drain Current (Peak) | I _{DP} | Pulse width ≤ 10 μs, Duty cycle ≤ 1/100 | 20 | |
| Continuous Source Current (DC) | I _S | | 10 | |
| Total Power Dissipation | P _T | | 65 | W |
| Repetitive Avalanche Current | I _{AR} | T _{ch} = 150°C | 10 | A |
| Single Avalanche Energy | E _{AS} | T _{ch} = 25°C | 260 | mJ |
| Repetitive Avalanche Energy | E _{AR} | T _{ch} = 25°C | 26 | |
| Dielectric Strength | V _{dis} | Terminals to case, AC 1 minute | 2 | kV |
| Mounting Torque | TOR | (Recommended torque : 0.5 N·m) | 0.8 | N·m |

● Electrical Characteristics $T_c = 25^\circ\text{C}$

| Item | Symbol | Conditions | Min. | Typ. | Max. | Unit |
|---|---------------|---|------|------|-----------|---------------------------|
| Drain-Source Breakdown Voltage | $V_{(BR)DSS}$ | $I_D = 1\text{mA}, V_{GS} = 0\text{V}$ | 900 | | | V |
| Zero Gate Voltage Drain Current | I_{DSS} | $V_{DS} = 900\text{V}, V_{GS} = 0\text{V}$ | | | 250 | μA |
| Gate-Source Leakage Current | I_{GSS} | $V_{GS} = \pm 30\text{V}, V_{DS} = 0\text{V}$ | | | ± 0.1 | |
| Forward Transconductance | g_{fs} | $I_D = 5\text{A}, V_{DS} = 10\text{V}$ | 4.8 | 8.0 | | S |
| Static Drain-Source On-state Resistance | $R_{DS(ON)}$ | $I_D = 5\text{A}, V_{GS} = 10\text{V}$ | | 1.05 | 1.4 | Ω |
| Gate Threshold Voltage | V_{TH} | $I_D = 1\text{mA}, V_{DS} = 10\text{V}$ | 2.5 | 3.0 | 3.5 | V |
| Source-Drain Diode Forward Voltage | V_{SD} | $I_S = 5\text{A}, V_{GS} = 0\text{V}$ | | | 1.5 | |
| Thermal Resistance | θ_{jC} | junction to case | | | 1.92 | $^\circ\text{C}/\text{W}$ |
| Total Gate Charge | Q_g | $V_{DD} = 400\text{V}, V_{GS} = 10\text{V}, I_D = 10\text{A}$ | | 90 | | nC |
| Input Capacitance | C_{iss} | | | 2150 | | |
| Reverse Transfer Capacitance | C_{rss} | $V_{DS} = 25\text{V}, V_{GS} = 0\text{V}, f = 1\text{MHz}$ | | 50 | | pF |
| Output Capacitance | C_{oss} | | | 210 | | |
| Turn-On Time | t_{on} | $I_D = 5\text{A}, R_L = 30\Omega, V_{GS} = 10\text{V}$ | | 140 | 250 | ns |
| Turn-Off Time | t_{off} | | | 440 | 740 | |

2SK2677

Transfer Characteristics

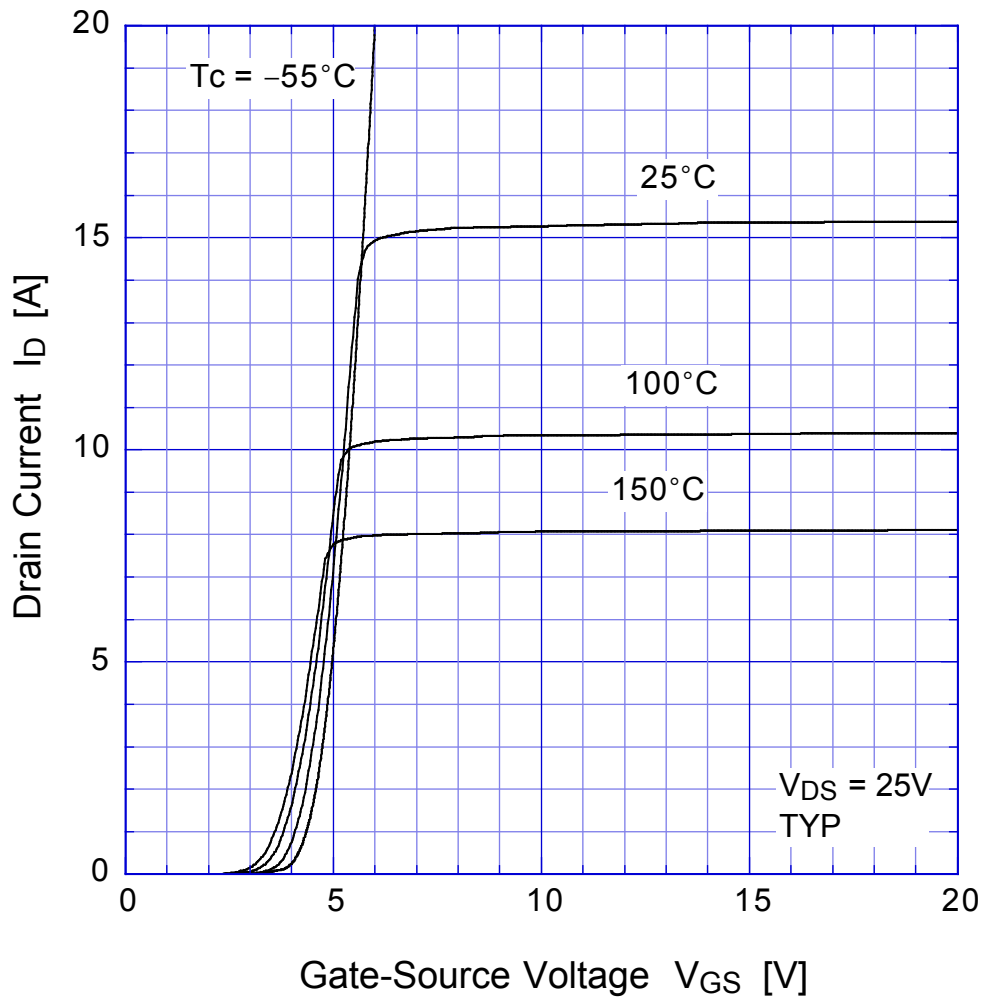

2SK2677 Static Drain-Source On-state Resistance

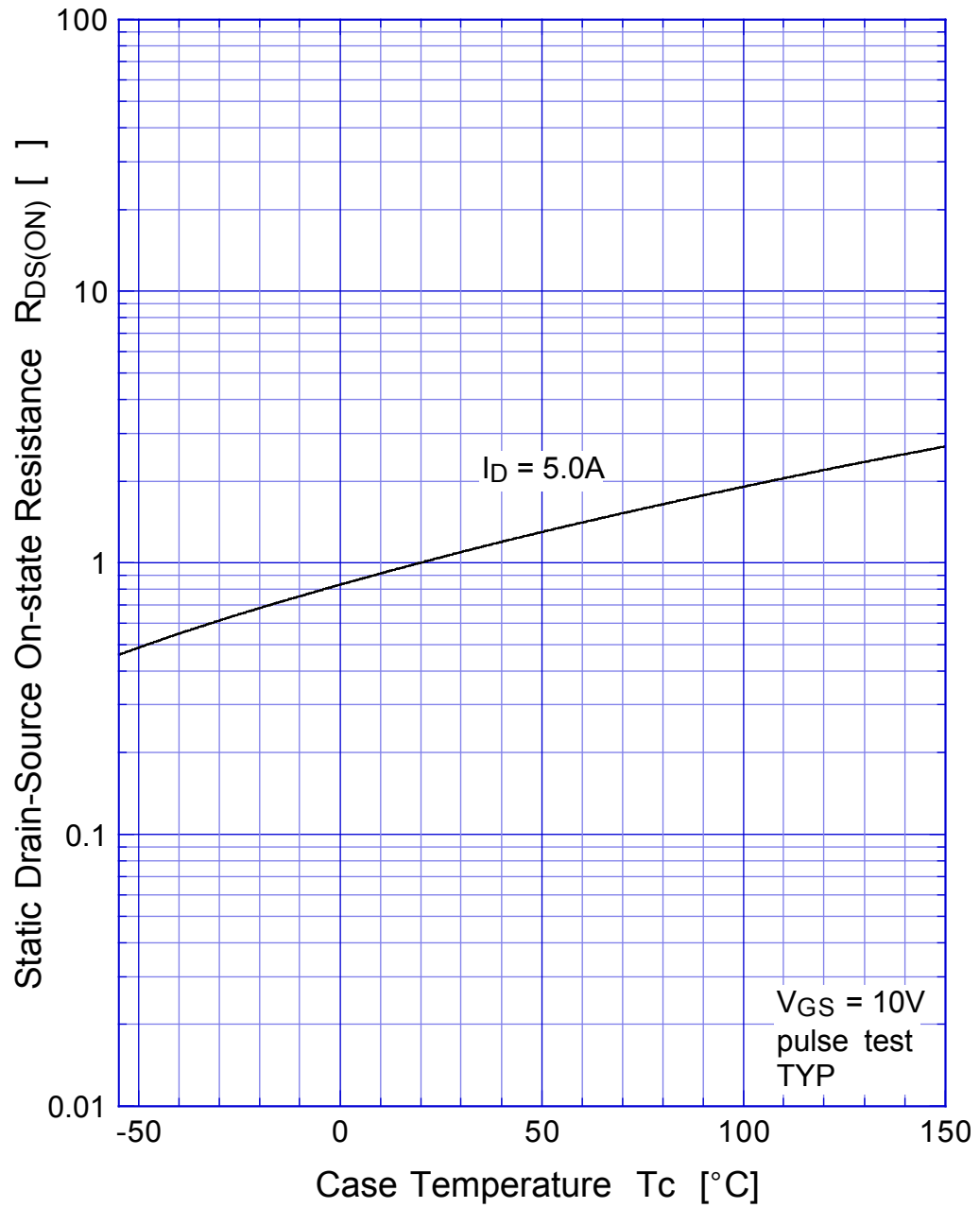

2SK2677 Gate Threshold Voltage

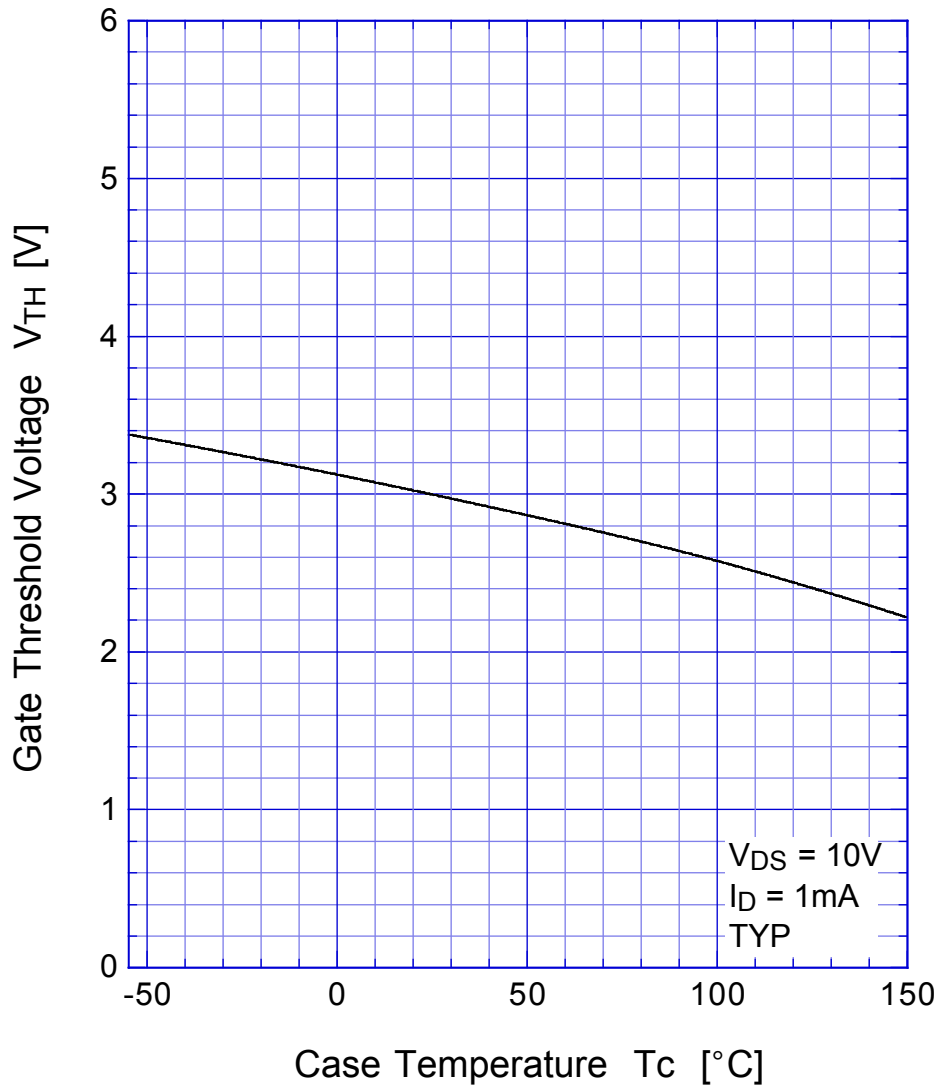

2SK2677 Safe Operating Area

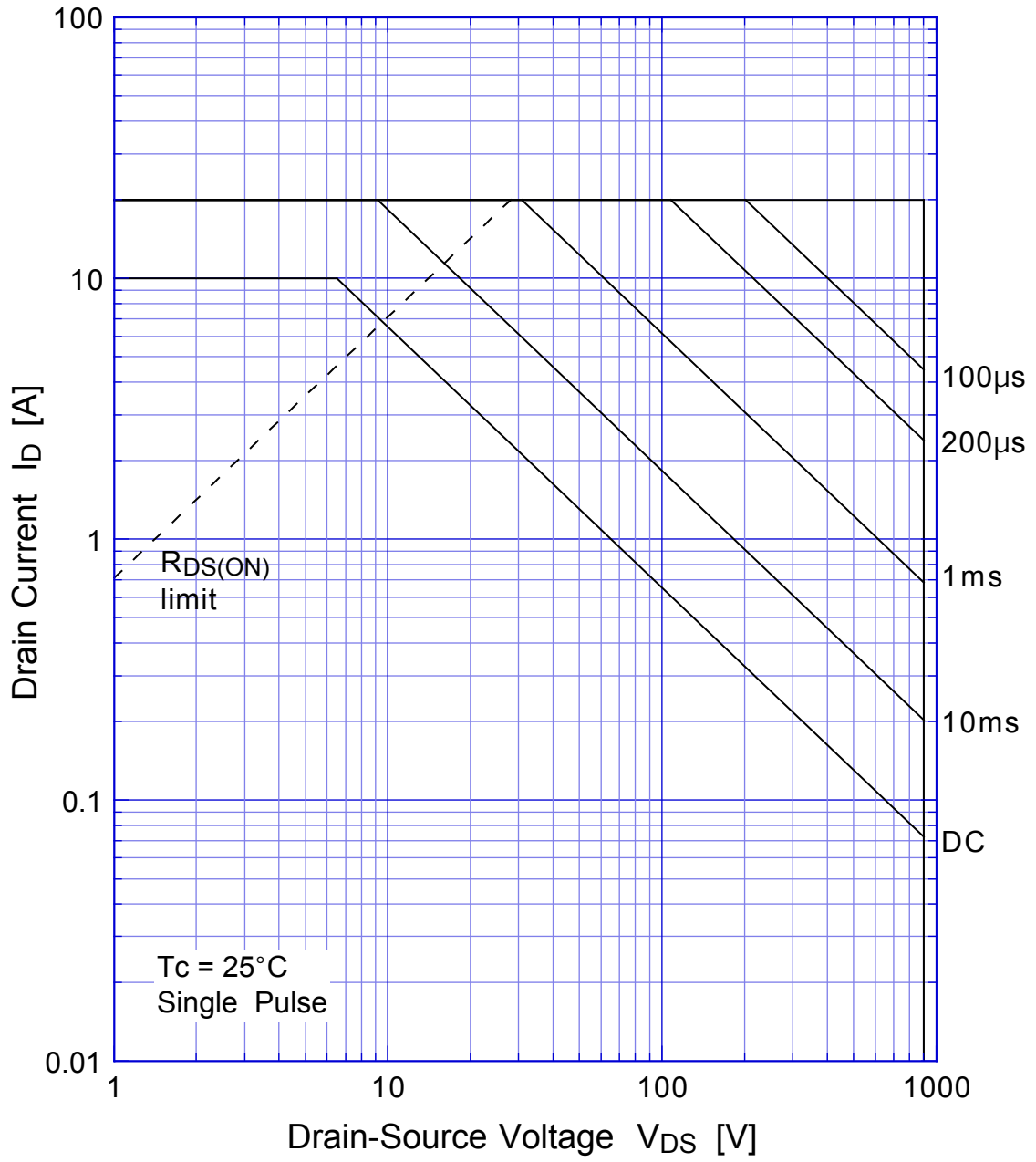

2SK2677 Transient Thermal Impedance

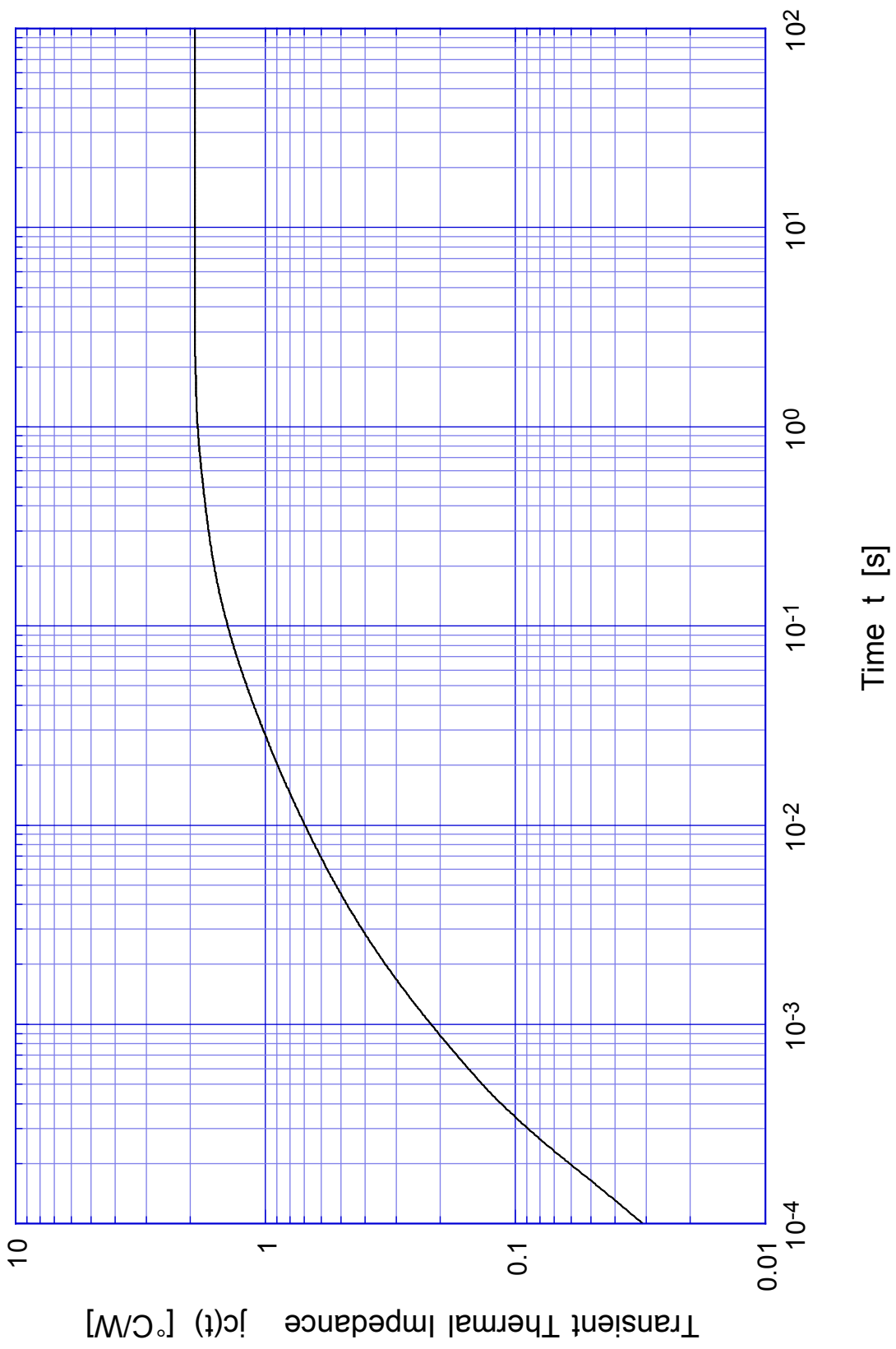

2SK2677 Single Avalanche Energy Derating

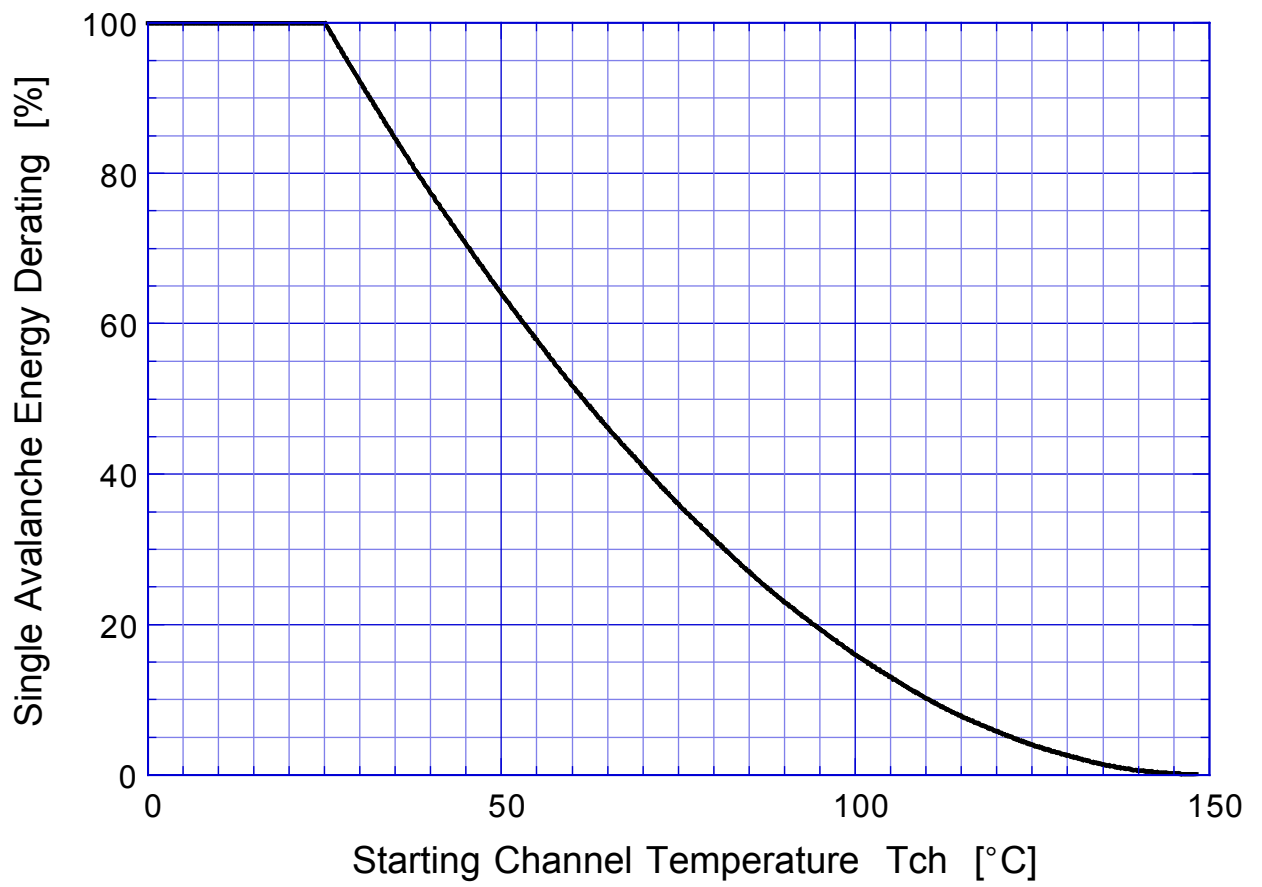

2SK2677

Capacitance

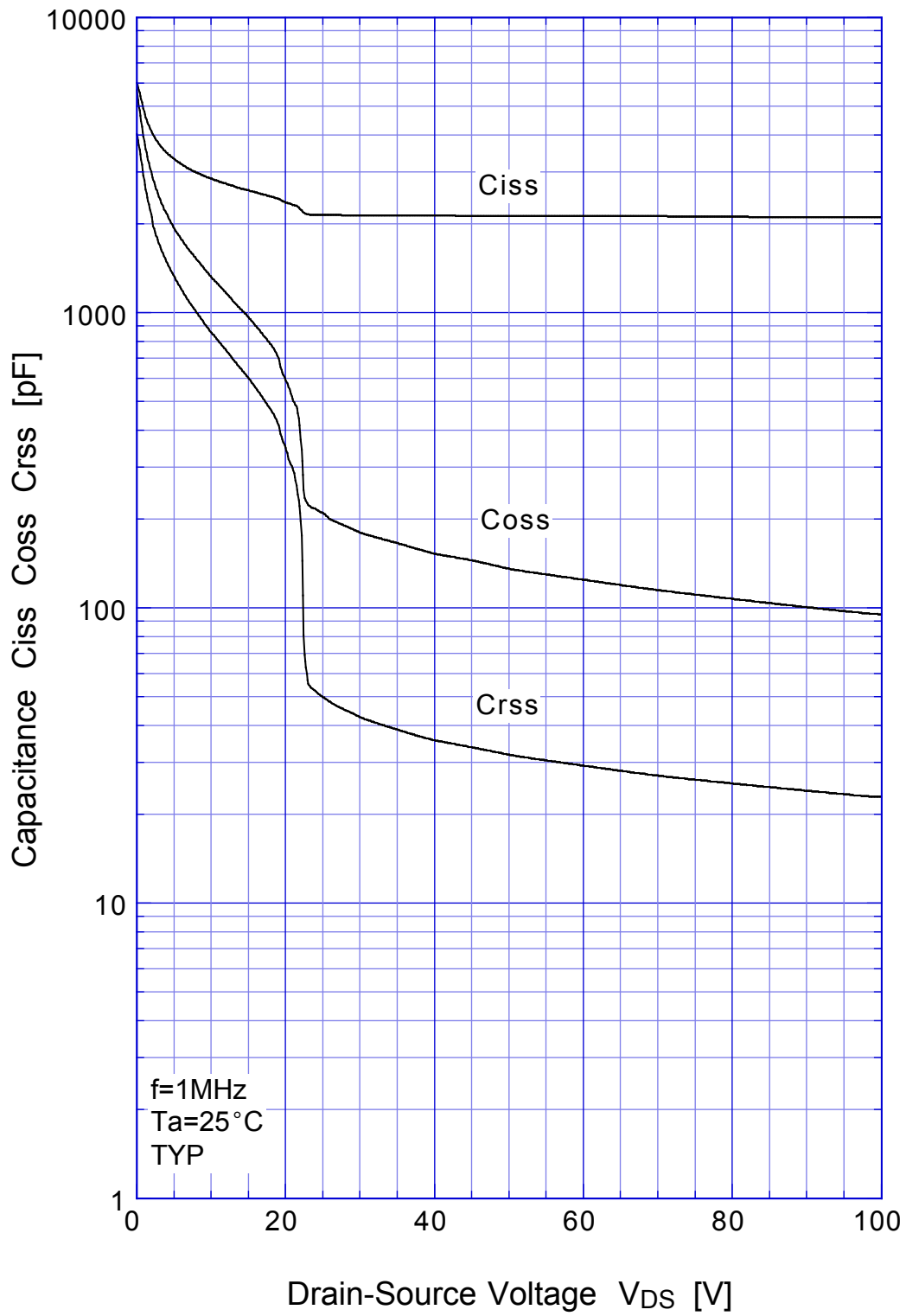

2SK2677 Single Avalanche Current - Inductive Load

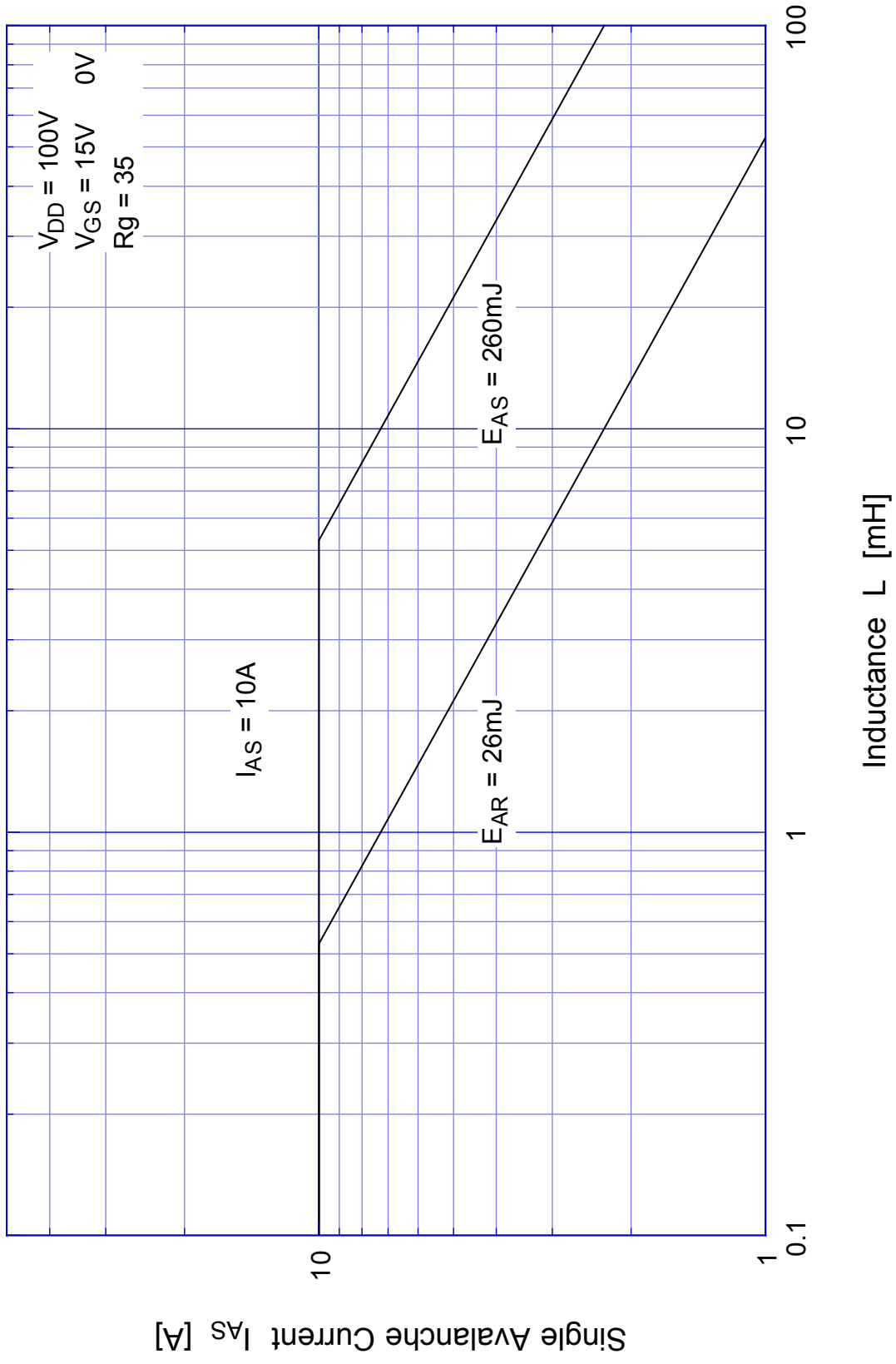

2SK2677

Power Derating

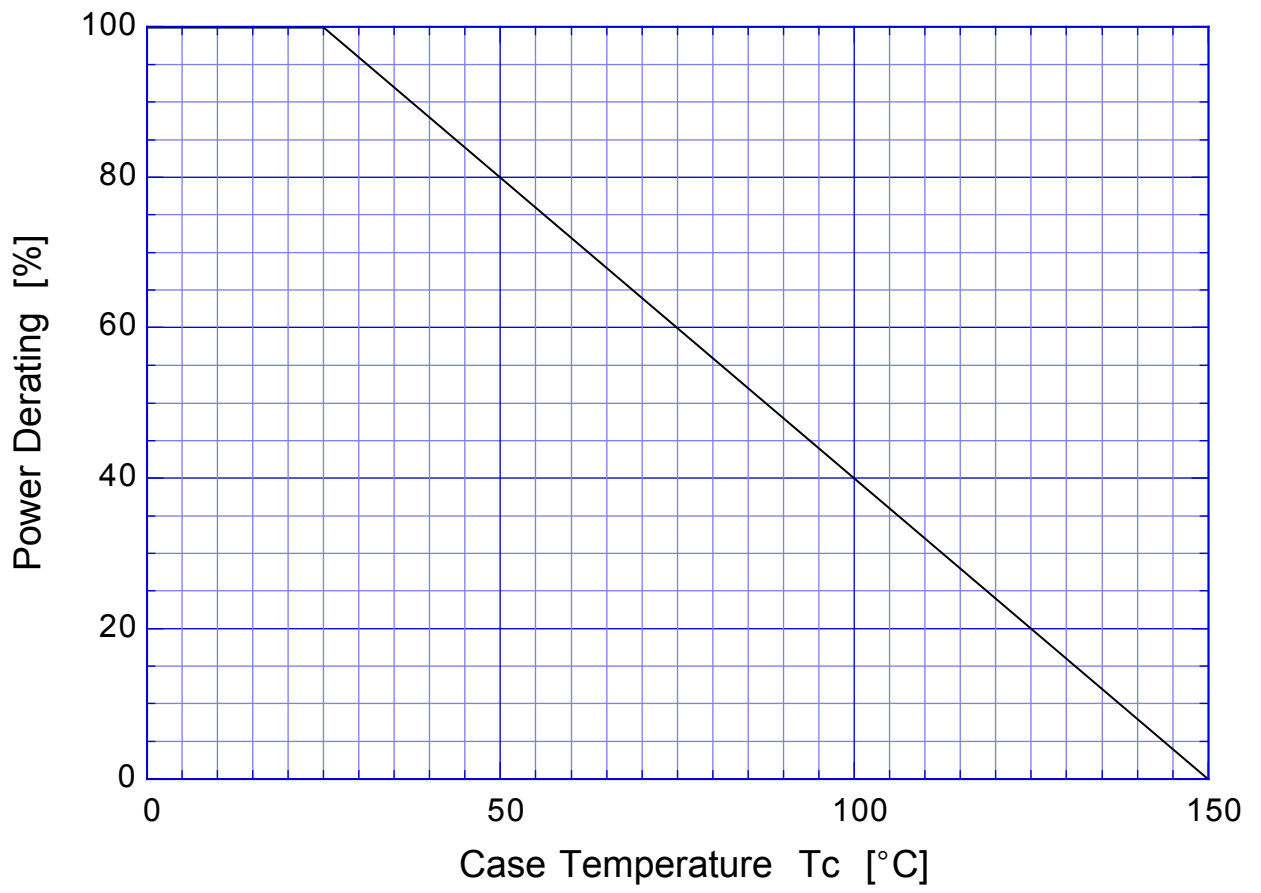

2SK2677 Gate Charge Characteristics

