

INTERNATIONAL RECTIFIER

INTERNATIONAL RECTIFIER **IOR**

T-39-11

HEXFET® TRANSISTORS IRFJ240

**N-CHANNEL
POWER MOSFETS**

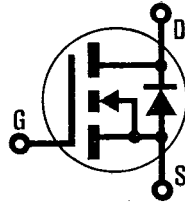

- IRFJ241**
- IRFJ242**
- IRFJ243**

200 Volt, 0.18 Ohm HEXFET

The HEXFET® technology is the key to International Rectifier's advanced line of power MOSFET transistors. The efficient geometry and unique processing of the HEXFET design achieve very low on-state resistance combined with high transconductance and great device ruggedness.

The HEXFET transistors also feature all of the well established advantages of MOSFETs such as voltage control, very fast switching, ease of paralleling, and temperature stability of the electrical parameters.

They are well suited for applications such as switching power supplies, motor controls, inverters, choppers, audio amplifiers, and high energy pulse circuits.

Features:

- Fast Switching
- Low Drive Current
- Ease of Paralleling
- Excellent Temperature Stability

Product Summary

Part Number	V _{DS}	R _{DS(on)}	I _D
IRFJ240	200V	0.18Ω	13A
IRFJ241	150V	0.18Ω	13A
IRFJ242	200V	0.22Ω	11A
IRFJ243	150V	0.22Ω	11A

CASE STYLE AND DIMENSIONS

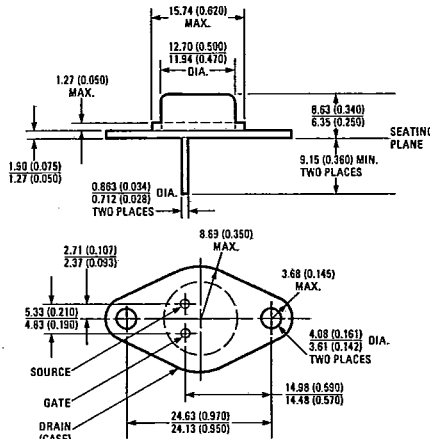
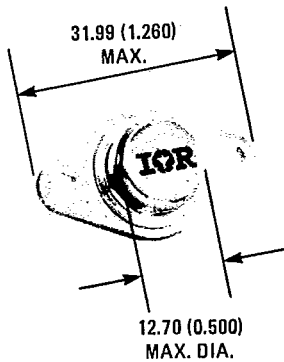

Conforms to JEDEC Case Style TO-213AA (TO-66)
Dimensions in Millimeters and (Inches)



IRFJ240, IRFJ241, IRFJ242, IRFJ243 Devices

INTERNATIONAL RECTIFIER

Absolute Maximum Ratings

T-39-11

11E D

4855452 0009569 9

Parameter	IRFJ240	IRFJ241	IRFJ242	IRFJ243	Units
V _{DS} Drain - Source Voltage (1)	200	150	200	150	V
V _{DGR} Drain - Gate Voltage (R _{GS} = 20 kΩ) (1)	200	150	200	150	V
I _D @ T _C = 25°C Continuous Drain Current	13	13	11	11	A
I _D @ T _C = 100°C Continuous Drain Current	8.0	8.0	7.0	7.0	A
I _{DM} Pulsed Drain Current (3)	50	50	40	40	A
V _{GS} Gate - Source Voltage	± 20				V
P _D @ T _C = 25°C Max. Power Dissipation	70 (See Fig. 14)				W
Linear Derating Factor	0.56 (See Fig. 14)				WK (4)
I _{LM} Inductive Current, Clamped	(See Fig. 15 and 16) L = 100μH				A
	50	50	40	40	
T _J Operating Junction and Storage Temperature Range	-55 to 150				°C
T _{stg} Lead Temperature	300 (0.063 in. (1.6mm) from case for 10s)				°C

Electrical Characteristics @ T_C = 25°C (Unless Otherwise Specified)

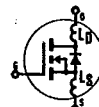
Parameter	Type	Min.	Typ.	Max.	Units	Test Conditions
BV _{DSS} Drain - Source Breakdown Voltage	IRFJ240 IRFJ242	200	-	-	V	V _{GS} = 0V
	IRFJ241 IRFJ243	150	-	-	V	I _D = 250μA
	ALL	2.0	-	4.0	V	V _{DS} = V _{GS} , I _D = 250μA
V _{GS(th)} Gate Threshold Voltage	ALL	2.0	-	4.0	V	V _{DS} = V _{GS} , I _D = 250μA
I _{GSS} Gate - Source Leakage Forward	ALL	-	-	100	nA	V _{GS} = 20V
I _{GSS} Gate - Source Leakage Reverse	ALL	-	-	-100	nA	V _{GS} = -20V
I _{DSS} Zero Gate Voltage Drain Current	ALL	-	-	250	μA	V _{DS} = Max. Rating, V _{GS} = 0V
		-	-	1000	μA	V _{DS} = Max. Rating x 0.8, V _{GS} = 0V, T _C = 125°C
I _{D(on)} On-State Drain Current (2)	IRFJ240 IRFJ241	13	-	-	A	V _{DS} > I _{D(on)} x R _{DS(on)max.} , V _{GS} = 10V
	IRFJ242 IRFJ243	11	-	-	A	
	ALL	-	0.14	0.18	Ω	
R _{DS(on)} Static Drain-Source On-State Resistance (2)	IRFJ240 IRFJ241	-	0.14	0.18	Ω	V _{GS} = 10V, I _D = 7.0A
	IRFJ242 IRFJ243	-	0.20	0.22	Ω	
g _{fs} Forward Transconductance (2)	ALL	6.0	9.0	-	S (Ω)	V _{DS} > I _{D(on)} x R _{DS(on)max.} , I _D = 7.0A
C _{iss} Input Capacitance	ALL	-	1275	1600	pF	V _{GS} = 0V, V _{DS} = 25V, f = 1.0 MHz See Fig. 10
C _{oss} Output Capacitance	ALL	-	500	750	pF	
C _{rss} Reverse Transfer Capacitance	ALL	-	160	300	pF	
t _{d(on)} Turn-On Delay Time	ALL	-	16	30	ns	V _{DD} = 75V, I _D = 7.0A, Z _o = 4.7Ω See Fig. 17 (MOSFET switching times are essentially independent of operating temperature.)
t _r Rise Time	ALL	-	27	60	ns	
t _{d(off)} Turn-Off Delay Time	ALL	-	40	80	ns	
t _f Fall Time	ALL	-	31	60	ns	
Q _g Total Gate Charge (Gate-Source Plus Gate-Drain)	ALL	-	43	60	nC	
Q _{gs} Gate-Source Charge	ALL	-	16	-	nC	Measured between the contact screw on header that is closer to source and gate pins and center of die. Modified MOSFET symbol showing the internal device inductances. 
Q _{gd} Gate-Drain ("Miller") Charge	ALL	-	27	-	nC	
L _D Internal Drain Inductance	ALL	-	5.0	-	nH	
L _S Internal Source Inductance	ALL	-	12.5	-	nH	Measured from the source pin, 6 mm (0.25 in.) from header and source bonding pad.

Thermal Resistance

Parameter	Units	Min.	Typ.	Max.	Units	Notes
R _{thJC} Junction-to-Case	K/W (4)	-	-	1.8	K/W (4)	
R _{thCS} Case-to-Sink	K/W (4)	-	0.2	-	K/W (4)	Mounting surface flat, smooth, and greased.
R _{thJA} Junction-to-Ambient	K/W (4)	-	-	50	K/W (4)	Typical socket mount

Source-Drain Diode Ratings and Characteristics

I_S	Continuous Source Current (Body Diode)	IRFJ240	—	—	13	A	Modified MOSFET symbol showing the integral reverse P-N junction rectifier.	T-39-11
		IRFJ241	—	—	11	A		
I_{SM}	Pulse Source Current (Body Diode) ③	IRFJ240	—	—	50	A		
		IRFJ241	—	—	40	A		
V_{SD}	Diode Forward Voltage ②	IRFJ240	—	—	2.0	V	$T_C = 25^\circ\text{C}, I_S = 13\text{A}, V_{GS} = 0\text{V}$	
		IRFJ241	—	—	1.9	V		
t_{rr}	Reverse Recovery Time	ALL	—	650	—	ns	$T_J = 150^\circ\text{C}, I_F = 13\text{A}, di_F/dt = 100\text{A}/\mu\text{s}$	
Q_{RR}	Reverse Recovered Charge	ALL	—	4.1	—	μC	$T_J = 150^\circ\text{C}, I_F = 13\text{A}, di_F/dt = 100\text{A}/\mu\text{s}$	
t_{on}	Forward Turn-on Time	ALL	Intrinsic turn-on time is negligible. Turn-on speed is substantially controlled by $L_S + L_D$.					



- ① $T_J = 25^\circ\text{C}$ to 150°C .
- ② Pulse Test: Pulse width $\leq 300\mu\text{s}$, Duty Cycle $\leq 2\%$.
- ③ Repetitive Rating: Pulse width limited by max. junction temperature. See Transient Thermal Impedance Curve (Fig. 5).
- ④ $K/W = ^\circ\text{C}/W$
 $W/K = W/^\circ\text{C}$

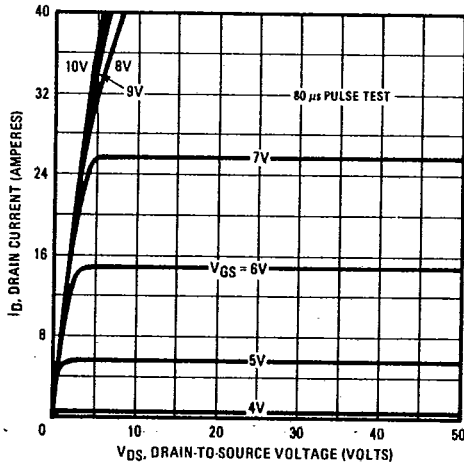

Fig. 1 - Typical Output Characteristics

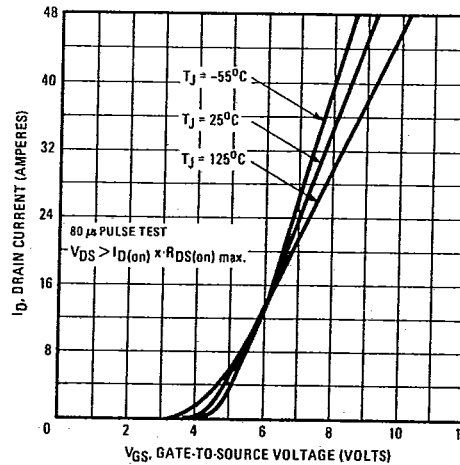

Fig. 2 - Typical Transfer Characteristics

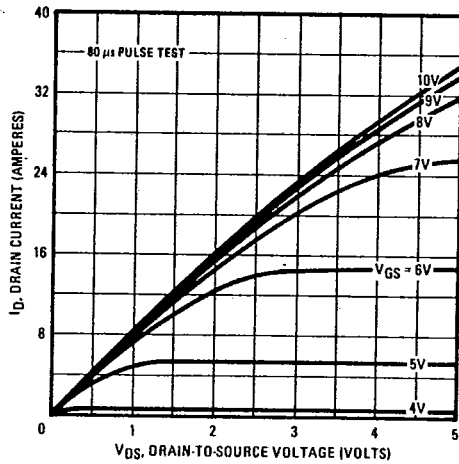

Fig. 3 - Typical Saturation Characteristics

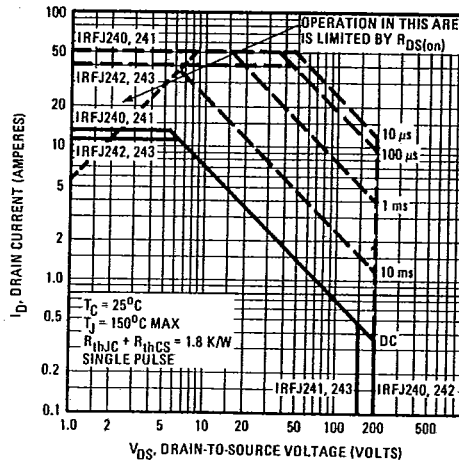

Fig. 4 - Maximum Safe Operating Area

T0-66

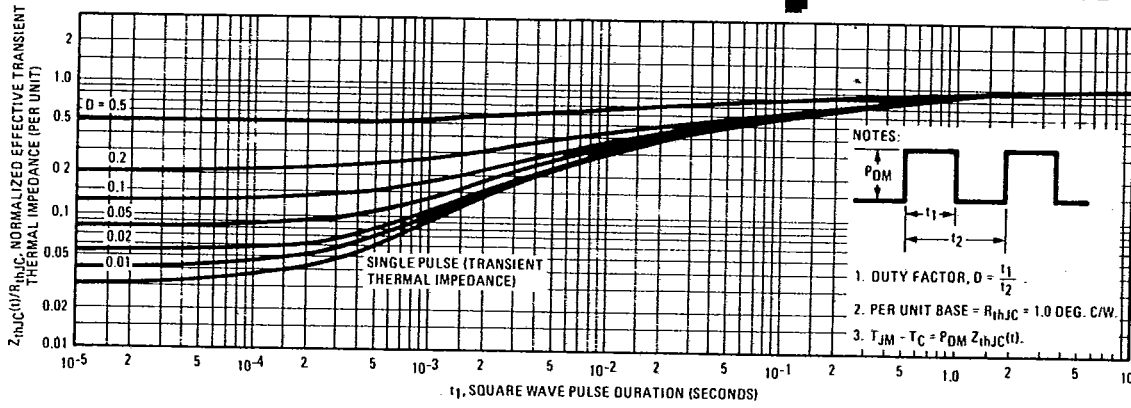

Fig. 5 -- Maximum Effective Transient Thermal Impedance, Junction-to-Case Vs. Pulse Duration

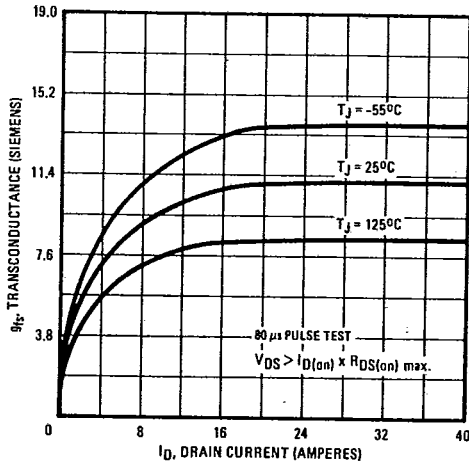

Fig. 6 -- Typical Transconductance Vs. Drain Current

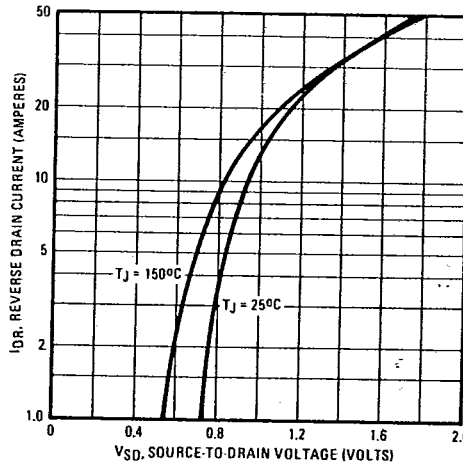

Fig. 7 -- Typical Source-Drain Diode Forward Voltage

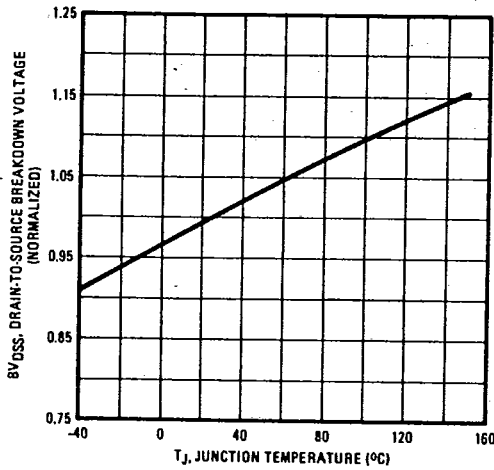

Fig. 8 -- Breakdown Voltage Vs. Temperature

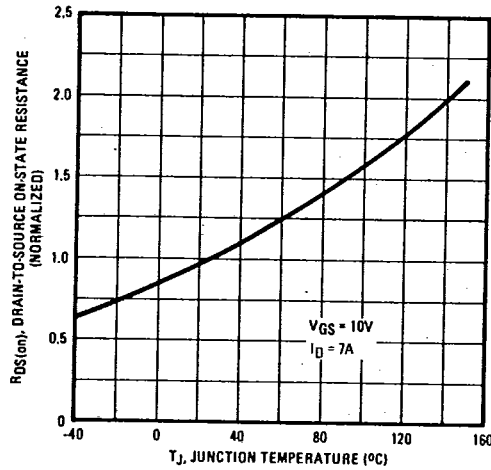

Fig. 9 -- Normalized On-Resistance Vs. Temperature

11E D 4855452 0009572 9

T-39-11

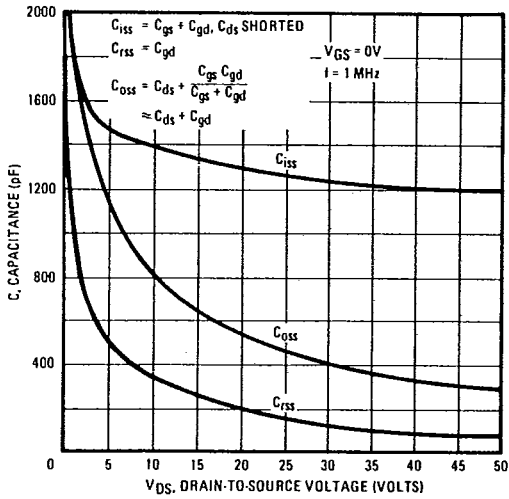

Fig. 10 - Typical Capacitance Vs. Drain-to-Source Voltage

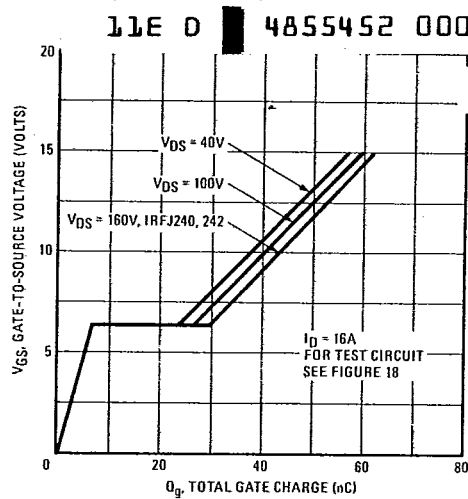

Fig. 11 - Typical Gate Charge Vs. Gate-to-Source Voltage

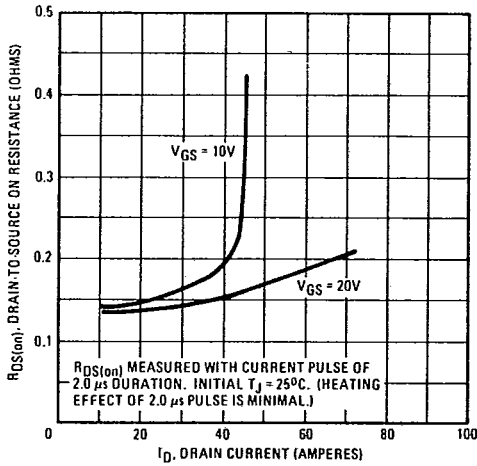

Fig. 12 - Typical On-Resistance Vs. Drain Current

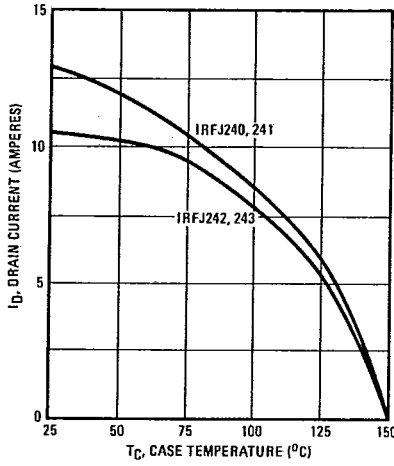

Fig. 13 - Maximum Drain Current Vs. Case Temperature

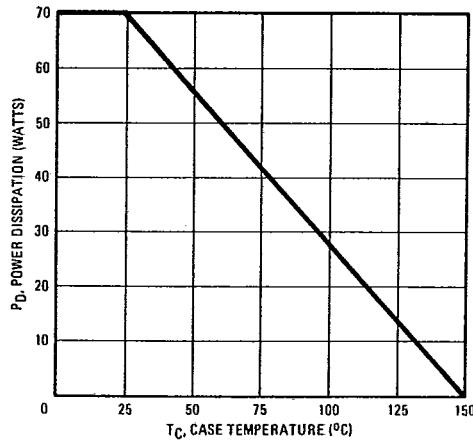

Fig. 14 - Power Vs. Temperature Derating Curve

G-549

TO-66

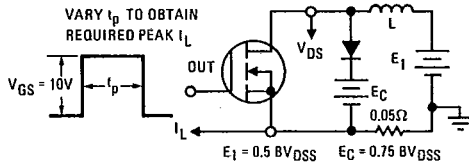

Fig. 15 - Clamped Inductive Test Circuit

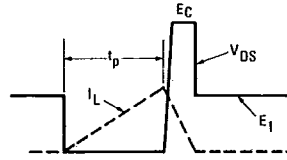

Fig. 16 - Clamped Inductive Waveforms

INTERNATIONAL RECTIFIER

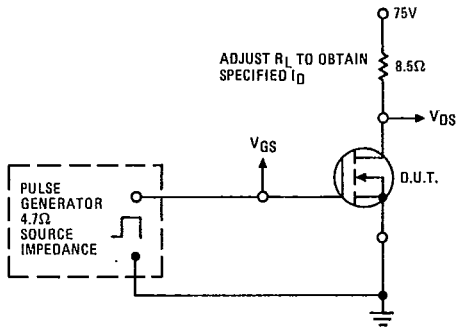

Fig. 17 - Switching Time Test Circuit

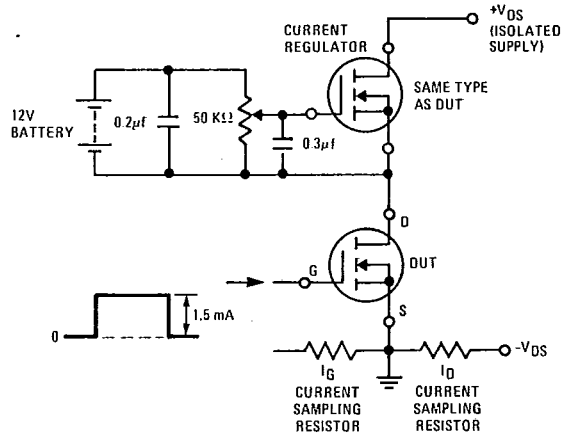

Fig. 18 - Gate Charge Test Circuit