

PROFET®

- High-side switch most suitable for inductive loads
- Short-circuit protection
- Overtemperature protection
- Overload protection
- Load dump protection
- Undervoltage and overvoltage shutdown with auto-restart and hysteresis
- Reverse battery protection
- Input and status protection
- Clamp of negative output voltage with inductive loads
- Protection against charged inductive load disconnect¹⁾
- Open load detection in ON-state
- Maximum current internally limited
- Status output for load fault
- R_{ON} constant versus V_{bb}
- Electrostatic Discharge (ESD) protection

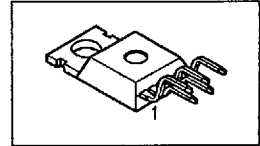

Version differences see truth table and options overview, page 152...153

Package: TO220AB/5 (mounting flange is shorted to pin 3),
different package outlines (see page 160) on request

Ordering codes and packages see page 160

Pins				
1	2	3	4	5
GND	IN	V_{bb}	ST	OUT
-	I	+	S	O (Load,L)

Maximum Ratings

Parameter	Symbol	Values	Unit	
Active overvoltage protection	$V_{bb(AZ)}$	> 50	V	
Load current (Short-circuit current, see page 151)	I_L	self-limited	A	
Operating temperature range	T_j	-40 ...+150	°C	
Storage temperature range	T_{stg}	-55 ...+150		
Max. power dissipation	P_{tot}	125	W	
Maximum current through input pin (DC)	I_{IN}	±2.0	mA	
Maximum current through status pin (DC)	I_{ST}	±5.0		
see internal circuit diagram see chapter 2				
Thermal resistance	chip - case	R_{thJC}	1	K/W
	chip - ambient:	R_{thJA}	75	

¹⁾ with 150 Ω resistor in GND connection or freewheeling diode between V_{bb} and GND or freewheeling diode parallel to load. To protect against V_{bb} loss with an inductive load, it is recommended that a freewheeling diode be added between V_{bb} and GND.



Electrical Characteristics

Parameter and Conditions at $T_j = 25^\circ\text{C}$, $V_{bb} = 12\text{V}$ unless otherwise specified	Symbol	Values			Unit
		min	typ	max	

Load Switching Capabilities and Characteristics

On-state resistance (pin 3 to 5) $I_L = 2\text{ A}$, $V_{IN} = \text{high}$	$T_j = 25^\circ\text{C}$: $T_j = 150^\circ\text{C}$:	R_{ON}	--	30 56	38 70	m Ω
Nominal load current (pin 3 to 5) ISO Proposal: $V_{bb} - V_{OUT} \leq 0.5\text{ V}$, $T_C = 85^\circ\text{C}$		$I_{L(ISO)}$	9	--	--	A
Open load detection current	$T_j = 25..150^\circ\text{C}$: $T_j = -40^\circ\text{C}$:	$I_{L(OL)}$	2 2	-- --	750 1000	mA
Turn-on time to 90% V_{OUT}		t_{on}	50	--	300	μs
Turn-off time to 10% V_{OUT}		t_{off}	10	--	60	μs
Slew rate on 10 to 30% V_{OUT} , $R_L = 12\ \Omega$		dV/dt_{on}	--	--	2	V/ μs
Slew rate off 70 to 40% V_{OUT} , $R_L = 12\ \Omega$		$-dV/dt_{off}$	--	--	4	V/ μs
Standby current (pin 3) $V_{IN} = 0$	$T_j = 150^\circ\text{C}$:	$I_{bb(off)}$	--	12 18	25 60	μA
Operating current (Pin 1), $V_{IN} = \text{high}$		I_{GND}	--	2.2 ²⁾	--	mA
Short circuit shutdown delay after input pos. slope $T_j = -40..+150^\circ\text{C}$: $V_{bb} - V_{OUT} = V_{ON} > V_{ON(SC)}$ (see page 151) min value valid only, if input "low" time exceeds 60 μs		$t_d(SC)$	80	--	350	μs

Input and Status Feedback³⁾

Allowable input voltage range, (pin 2 to 1)		V_{IN}	-0.5	--	5.5	V
Input turn-on threshold voltage 		$V_{IN(T+)}$	1.5	--	2.4	V
Input turn-off threshold voltage 		$V_{IN(T-)}$	0.8	--	--	V
Input threshold hysteresis		$\Delta V_{IN(T)}$	--	0.5	--	V
Off state input current (pin 2) $V_{IN(off)} = 0.4\text{ V}$		$I_{IN(off)}$	1	--	30	μA
On state input current (pin 2) $V_{IN(on)} = 3.5\text{ V}$		$I_{IN(on)}$	10	25	70	μA
Delay time for status with open load (see timing diagrams, page 159)		$t_d(ST\ OL1)$ $t_d(ST\ OL2)$	--	700 200	--	μs
Status valid after input slope (short circuit, open load)	$T_j = -40 \dots +150^\circ\text{C}$:	$t_d(ST)$	80	--	350	μs

²⁾ see diagram page 157, Add I_{ST} , if $I_{ST} > 0$

³⁾ if a ground resistor R_{GND} is used, add the voltage across this resistor. Internal Z-diode typ. 6.1 V, see maximum ratings page 149, (see chapter 3)

Parameter and Conditions at $T_j = 25\text{ }^\circ\text{C}$, $V_{bb} = 12\text{V}$ unless otherwise specified	Symbol	Values			Unit
		min	typ	max	
Status output (open drain)					
zener limit voltage, $T_j = +25\text{ }^\circ\text{C}$:	$V_{ST(\text{high})}$	5.5	6.1	6.6	V
$T_j = -40\dots+150\text{ }^\circ\text{C}$:		5.4	--	6.9	
$T_j = -40\dots+25\text{ }^\circ\text{C}$, $I_{ST} = +1.6\text{mA}$:	$V_{ST(\text{low})}$	--	--	0.8	mA
$T_j = +150\text{ }^\circ\text{C}$, $I_{ST} = +1.6\text{ mA}$:		--	--	1.0	
	I_{ST}	--	--	1.6	

Operating and Clamp Voltages

Operating voltage	$T_j = 25\text{ }^\circ\text{C}$: $T_j = -40\dots+150\text{ }^\circ\text{C}$:	$V_{bb(\text{on})}$	4.9 5.8	--	42 40	V
Undervoltage shutdown	$T_j = 25\dots+150\text{ }^\circ\text{C}$: $T_j = -40\text{ }^\circ\text{C}$:	$V_{bb(\text{under})}$	2.4 3.0	--	4.9 5.4	
Undervoltage restart	$T_j = 25\dots+150\text{ }^\circ\text{C}$: $T_j = -40\text{ }^\circ\text{C}$:	$V_{bb(\text{u rst})}$	-- --	--	4.9 5.8	
Overvoltage shutdown	$T_j = -40\dots+150\text{ }^\circ\text{C}$:	$V_{bb(\text{over})}$	42	--	52	
Overvoltage restart	$T_j = -40\dots+150\text{ }^\circ\text{C}$:	$V_{bb(\text{o rst})}$	40	--	--	
Overvoltage protection	$T_j = -40\dots+150\text{ }^\circ\text{C}$:	$V_{bb(\text{AZ})}$	50	56	--	
Load dump protection		$V_{bb(\text{LD})}$	--	--	93.5	
Output clamp (inductive load switch off)		$-V_{OUT(\text{CL})}$	--	10	--	
Short circuit shutdown detection voltage (pin 3 to 5)		$V_{ON(\text{SC})}$	--	8.6	10	

Protection Functions

Overload current limit (pin 3 to 5), after 50 ms, $V_{ON} = 8\text{V}$, no heatsink ⁴⁾ , see diagram page 155 $T_j = -40\dots+150\text{ }^\circ\text{C}$	$I_{L(\text{lim})}$	3.5	15.3	32	A
Thermal overload trip temperature	T_{IT}	150	--	--	$^\circ\text{C}$
Inductive load switch-off energy dissipation ⁵⁾ , $T_j \text{ start} = 150\text{ }^\circ\text{C}$, $V_{bb} = 12\text{V}$ $E_{\text{Load}} = \frac{1}{2} * L * I_L^2$	E_{ab} $E_{\text{Load}12}$ $E_{\text{Load}24}$	-- -- --	-- -- --	1.7 0.8 0.5	J
Reverse battery (pin 1 to 3) ⁶⁾	$-V_{bb}$	--	--	32	V

4) this occurs, if circuit resistance is so high, that no short circuit shutdown occurs ($V_{ON} < V_{ON(\text{SC})}$)

5) while demagnetizing load inductance, dissipated energy in PROFET is $E_{ab} = \int (V_{bb} + |V_{OUT(\text{CL})}|) * I_L(t) dt$,
approx. $E_{ab} = \frac{1}{2} * L * I_L^2 * (1 + \frac{V_{bb}}{|V_{OUT(\text{CL})}|})$

6) Reverse load current (through intrinsic drain-source diode) is normally limited by the connected load. Reverse current I_{GND} of about 0.4 A at $V_{bb} = -32\text{V}$ through the logic (see chapter 3) heats up the device. Time allowed under these condition is dependent on the size of the heatsink. Reverse I_{GND} can be reduced by an additional external GND-resistor (150 Ω). Input and Status currents have to be limited. In case of using GND-resistor it is recommended that 15k Ω resistors be inserted in series with IN and ST.

Truth Table

	Input-level	Output level	Status		
			version D	version E/F	version I1
Normal operation	L	L	H	H	H
	H	H	H	H	H
Open load	L	7)	H	H	L
	H	H	L	L	H
Short circuit to GND	L	L	H	H	H
	H	L	L	L	L
Short circuit to V_{bb}	L	H	H	H	L
	H	H	H (L ⁸⁾)	H (L ⁹⁾)	H
Overtemperature	L	L	L	L	L
	H	L	L	L	L
Undervoltage	L	L	L ⁹⁾	H	L ⁹⁾
	H	L	L ⁹⁾	H	L ⁹⁾
Overvoltage	L	L	L	H	L
	H	L	L	H	L

L = "Low" Level

H = "High" Level

7) Power Transistor off, high impedance

8) low resistance to V_{bb} may be detected by no-load-detection

9) no current sink capability during undervoltage shutdown

Options Overview

all versions: High-side switch, Input protection, ESD protection, load dump and reverse battery protection

Type	BTS	432D	432E	432F	432I1
Logic version		D	E	F	I
Overtemperature protection $T_j > 150\text{ }^\circ\text{C}$, latch function ¹⁰⁾		X		X	X
$T_j > 150\text{ }^\circ\text{C}$, with auto-restart on cooling			X		
Short-circuit to GND protection switches off when $V_{bb} - V_{OUT} > 3.5\text{ V}$ typ. (when first turned on after approx. 150 μs) switches off when $V_{bb} - V_{OUT} > 8.6\text{ V}$ typ. (when first turned on after approx. 150 μs) Achieved through overtemperature protection		X	X	X	X
Open load detection in OFF-state with sensing current 30 μA typ. in ON-state with sensing voltage drop across power transistor		X	X	X	X
Undervoltage shutdown with auto restart		X	X	X	X
Overvoltage shutdown with auto restart		X	X	X	X
Status feedback for					
overtemperature		X	X	X	X
short circuit to GND		X	X	X	X
short to V_{bb}					X
open load		X	X	X	X
undervoltage, overvoltage		X			X
Status output type					
CMOS		X			X
Open drain			X	X	
Output negative voltage transient limit (fast inductive load switch off)					
to -10 V typ		X	X	X	
to -16 V typ					X
Load current limit					
high level (can handle loads with high inrush currents)		X	X		
low level (better protection of application)				X	X

¹⁰⁾ Latch except when $V_{bb} - V_{OUT} < V_{ON(SC)}$ after shutdown. In most cases $V_{OUT} = 0\text{ V}$ after shutdown ($V_{OUT} \neq 0\text{ V}$ only if forced externally). So the device remains latched unless $V_{bb} < V_{ON(SC)}$ (see page 151). No latch between turn on and $t_{d(SC)}$.

Maximum allowable power dissipation
 $P_{tot} = f(T_C)$

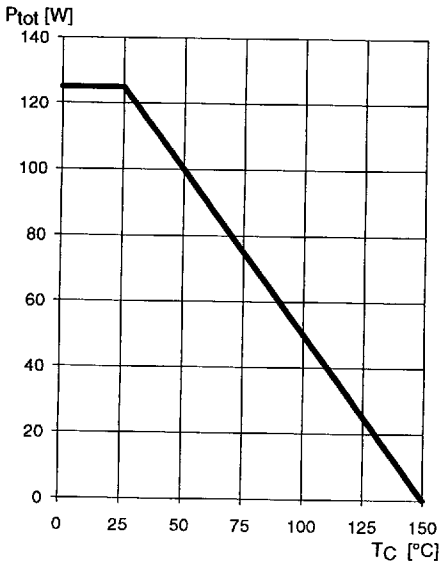

Typ. on-state resistance (V_{bb}-Pin to OUT-Pin)

$R_{ON} = f(V_{bb}, I_L)$; $V_{IN} = \text{high}$, $T_j = 25^\circ\text{C}$

R_{ON} [mOhm]

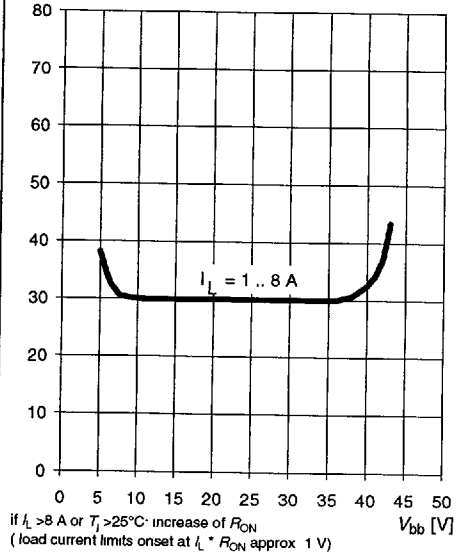

On-state resistance (V_{bb}-Pin to OUT-Pin)

$R_{ON} = f(T_j)$; $V_{bb} = 9..35\text{V}$; $I_L = 2 \text{ A}$; $V_{IN} = \text{high}$

R_{ON} [mOhm]

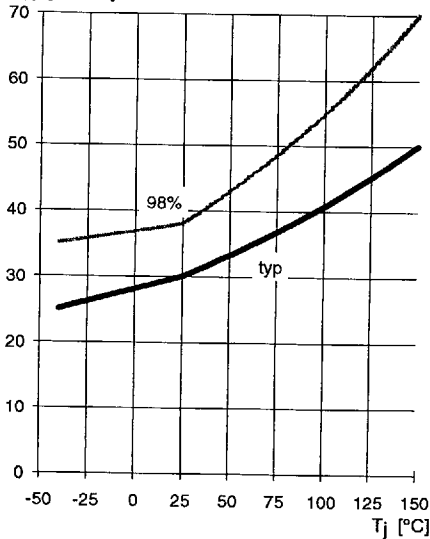

Max. case temperature vs DC load current

$T_C \text{ max} = f(I_L)$

T_C [°C]

432

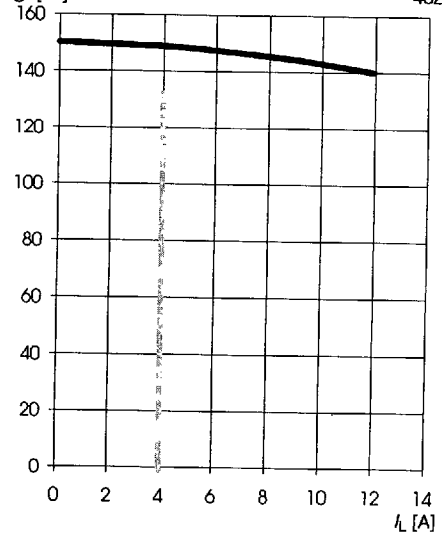

Typ. open load detect current

$I_L(OL) = f(T_j)$; $V_{bb}=9...35\text{ V}$; $V_{IN}=\text{high}$
 $I_L(OL)$ [mA]

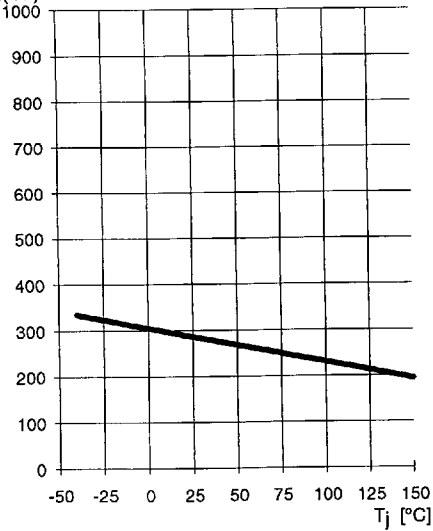

Typ. standby current

$I_{bb(off)} = f(T_j)$, $V_{bb}=9...35\text{ V}$, $V_{IN}=\text{low}$
 $I_{bb(off)}$ [μA]

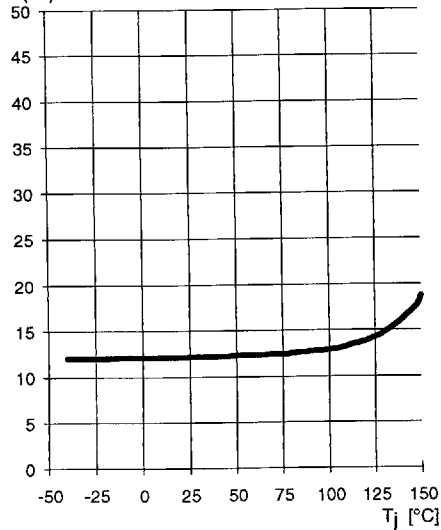

Typ. overload current

$I_L(\text{lim}) = f(t)$; $V_{bb}=12\text{ V}$, $V_{bb}-V_{OUT}=8\text{ V}$,
 no heatsink, Parameter: T_j start
 $I_L(\text{lim})$ [A]

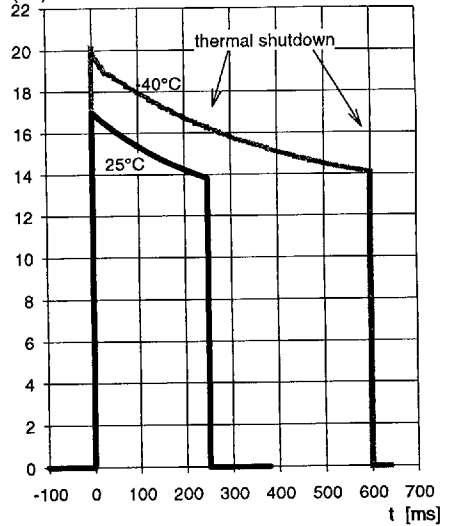

Typ. short circuit Current

$I_L(SC) = f(V_{ON})$; $T_j=25^\circ\text{C}$
 $I_L(SC)$ [A]

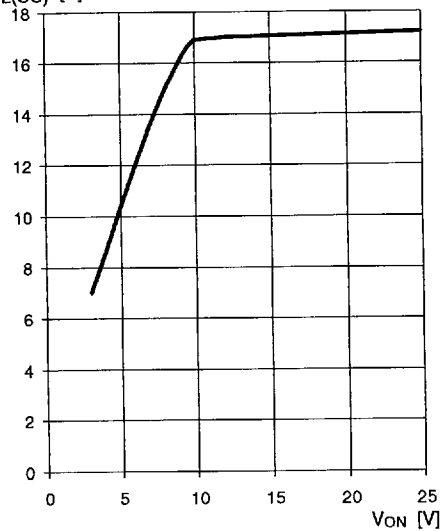

Short circuit current

max duration 350 μ s prior to shutdown

$I_{L(SC)} = f(T_j); V_{bb} = 12 \dots 35 \text{ V};$

$I_{L(SC)} [\text{A}]$

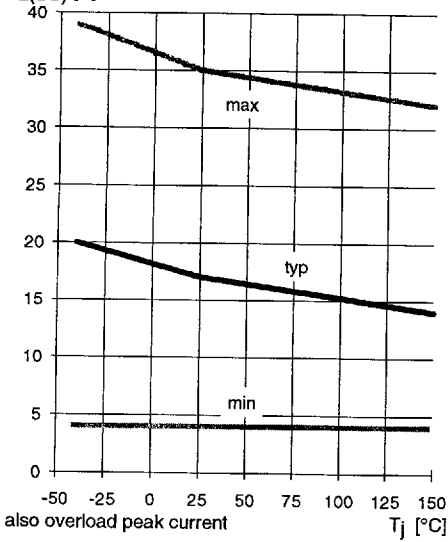

Typ. input current high

$I_{IN(on)} = f(T_j) \quad V_{IN} = 3.5 \dots 5.5 \text{ V}$

$I_{IN(on)} [\mu\text{A}]$

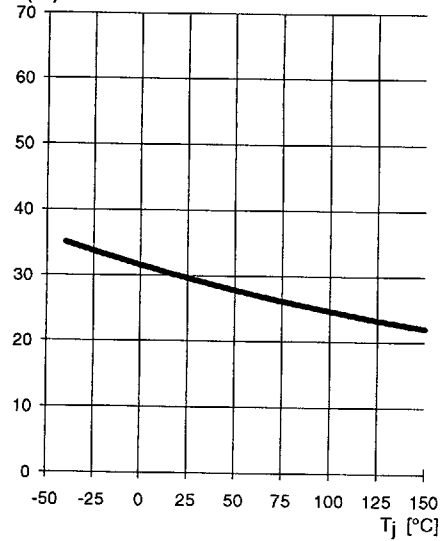

Typ. input turn on voltage threshold

$V_{IN(T+)} = f(T_j); V_{bb} = 9 \dots 35 \text{ V}$

$V_{IN(T+)} [\text{V}]$

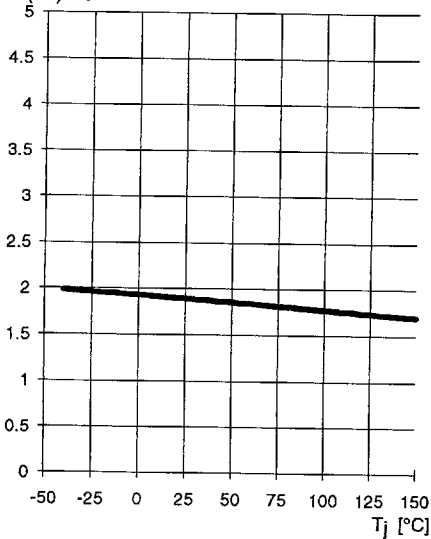

Typ. input current

$I_{IN} = f(V_{IN}), V_{bb} = 9 \dots 35 \text{ V}, T_j = 25^\circ\text{C}$

$I_{IN} [\mu\text{A}]$

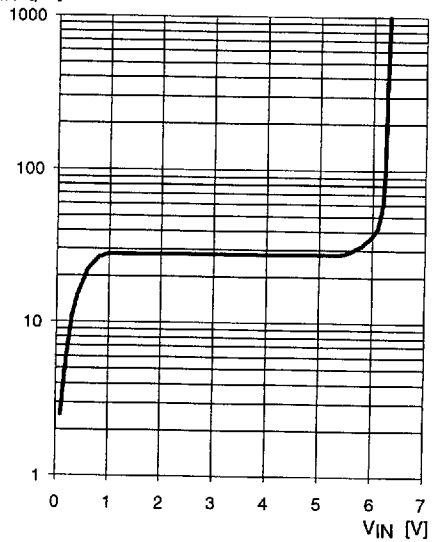

Typ. ground pin operating current

$I_{GND} = f(V_{bb}, T_j)$; $V_{IN} = \text{high}$
 I_{GND} [mA]

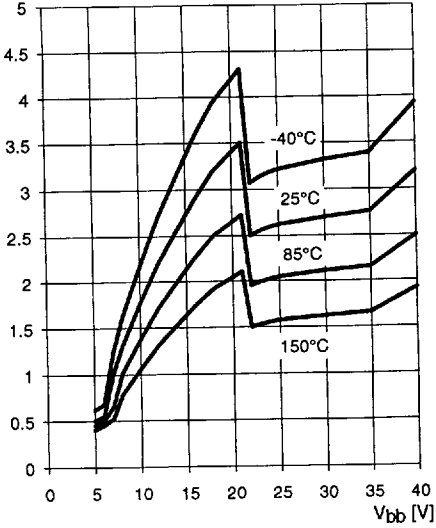

Typ. status low voltage

$V_{ST(\text{low})} = f(I_{ST})$, $V_{bb} = 9 \dots 35V$, $T_j = 25^\circ\text{C}$
 $V_{ST(\text{low})}$ [V]

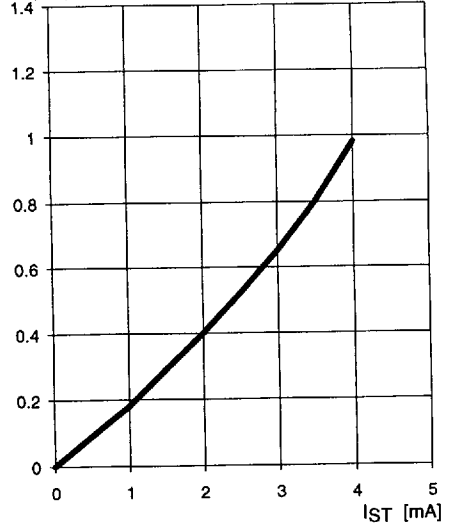

Typ. status zener limit voltage

$V_{ST(\text{high})} = f(T_j)$
 $V_{ST(\text{high})}$ [V]

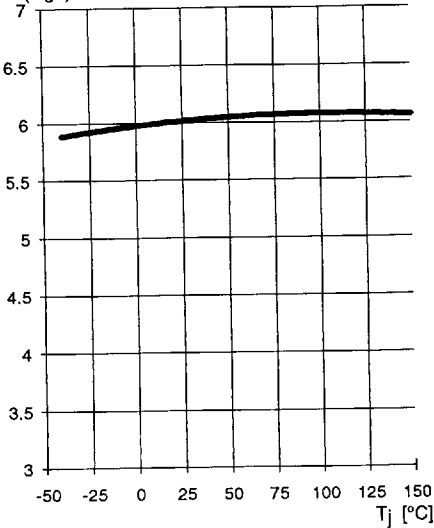

Timing diagrams

Figure 1a: V_{bb} turn on:

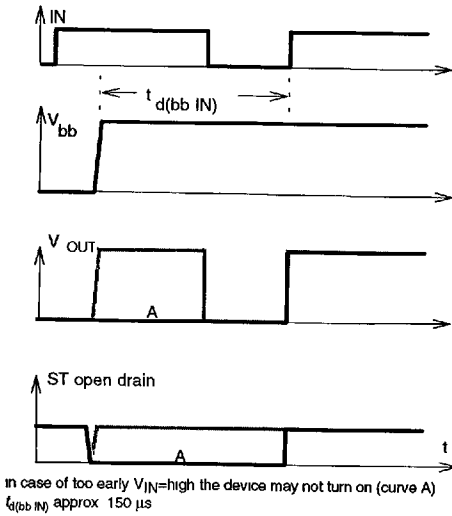
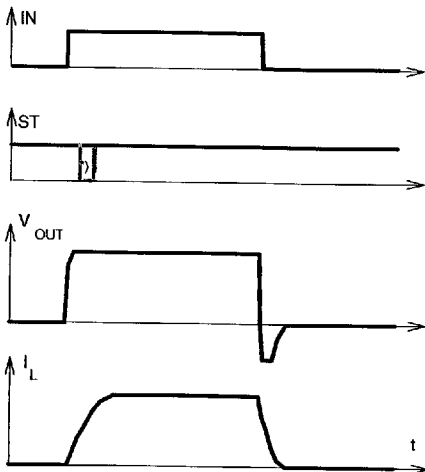

Figure 2a: Switching an inductive load,

(Better protection of application: versions BTS 432 F)



*) if the time constant of load is too large, open-load-status may occur

Figure 3a: turn on into short circuit,

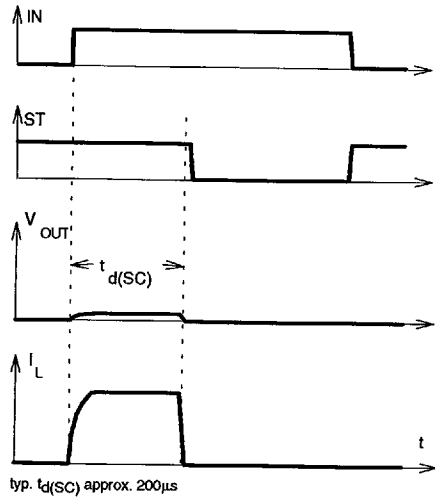

Figure 3b: short circuit while on:

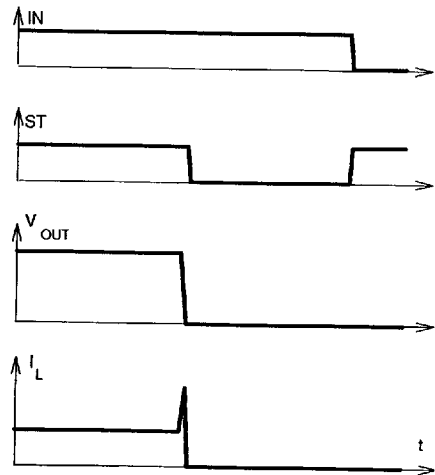
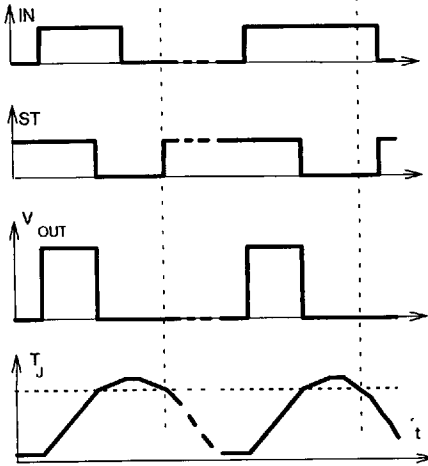

Figure 4a: overtemperature,

Reset if (IN=low) and ($T_j < T_{jt}$)



*) ST goes high, when V_{IN} =low and $T_j < T_{jt}$

Figure 5a: open load: detection in ON-state, turn on to open load

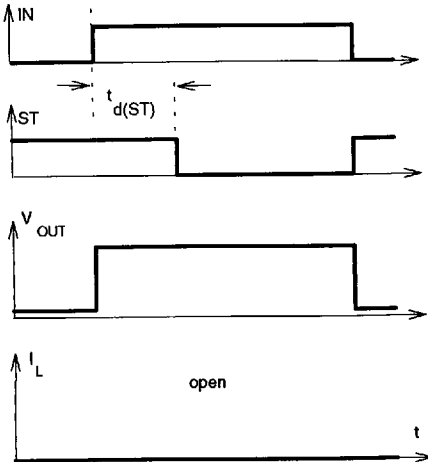
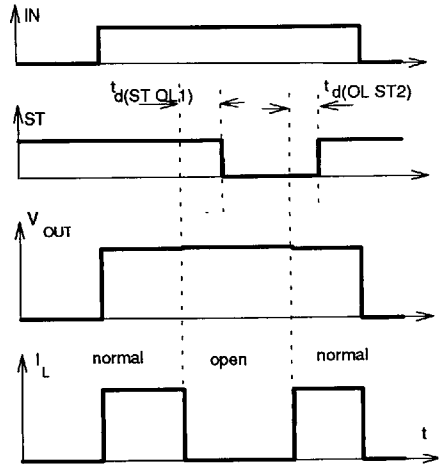

Figure 5b: open load: detection in ON-state, open load occurs in on-state



Package and ordering code

Standard

BTS 432 F	C67078-S5303-A5
-----------	-----------------

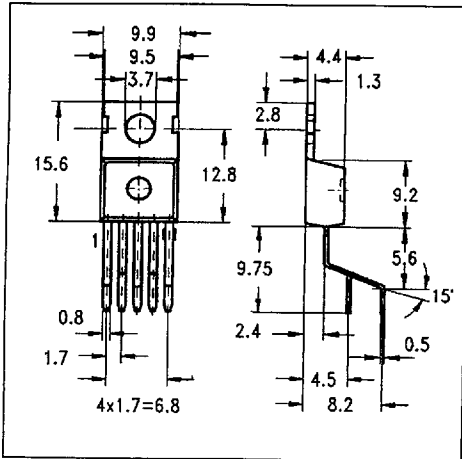

E3043

BTS 432 F	C67078-S5303-A16
-----------	------------------

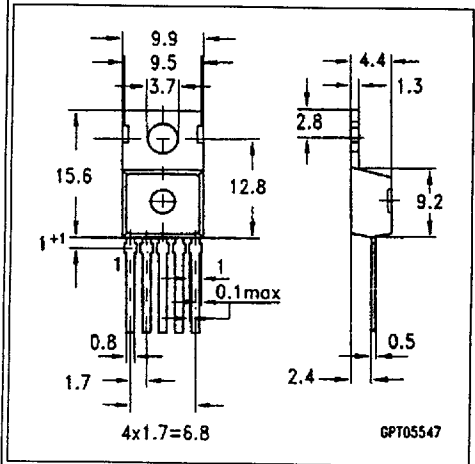

E3040

BTS 432 F	C67078-S5303-A9
-----------	-----------------

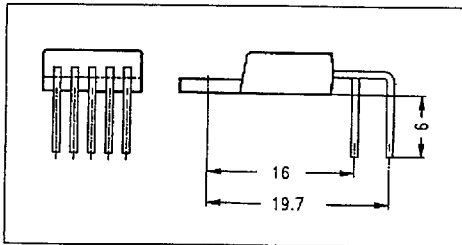

SMD

BTS 432 F E3062	Tube: C67078-S5303-A10
-----------------	------------------------

