

Series

Page

Subminiature D connectors
according to DIN 41 652 and MIL-C-24 308 - IEC 807

Technical characteristics

9, 15, 25, 37, 50 way

6

Male and female connectors

7

Solder buckets



Solder pins, straight

8



Standard Versions

Mounting height 7.3 mm 9-37 way
8.7 mm 50 way

10



U. S. Footprint Versions

Mounting height 6.3 mm 9-37 way

12

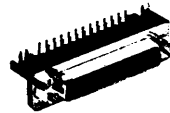

Solder pins, angled

Mounting details

13

Original Versions

Mounting height 7.3 mm 9-37 way
8.7 mm 50 way

14



Crimp terminal

16

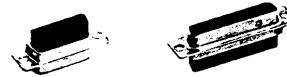

Wrap posts

19



Insulation displacement termination

20

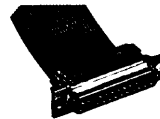

Hoods and accessories

22



D-Sub in Heavy Duty

29



Some of the components from the HARTING range

30



List of part numbers

31

Addresses

34

HARTING D-Sub connectors



for economical and reliable connections

The D-Sub series of connectors has become the standard industry input/output interface for use in data communications, office equipment, computer engineering, telecommunications and measurement and control systems.

HARTING D-Sub connectors comply with DIN 41 652, MIL-C-24 308 and IEC 807.

UI recognized.

The Advantages

- High packaging density
- All round protection against harsh operating conditions provided by polarized metal shell
- Ground continuity via dimples
- Tinned or yellow chromated metal shell
- Various termination techniques for universal compatibility
- Selective gold plating of contacts
- Precision contacts, turned or stamped
- Comprehensive range of accessories
- Up to date hood design

The Terminations

- Solder buckets for discrete wiring
- Straight solder pins with or without grounding contacts
- Angled solder pins with metal shell and with or without grounding contacts in different versions
- Wrap posts for automated wiring techniques
- Crimp termination for high volume and flexible contact loading, while maintaining consistent quality
- Insulation displacement contacts for economical and reliable connections

For "non standard applications" we can manufacture designs to match your requirements. Please discuss requirements with us.

HARTING D-Sub connectors incorporate the latest design features and provide the assurance of high quality and reliability with economy.

Sales Department
HARTING-Components

General Information

It is the user's responsibility to check whether the components illustrated in this catalogue comply with different regulations from those stated in special fields of application which we are unable to foresee.

We reserve the right to modify designs in order to improve quality, keep pace with technological advancement or meet particular requirements in production.

This catalogue must not be used in any form or manner without our prior approval in writing (Copyright Law, Fair Trading Law, Civil Code).

We are bound by the French version only.

HARTING – Guarantee a Secure Connection

Modern electronic applications demand a high degree of mechanical and electrical security.

To meet this requirement continuous screening from the cable to the P.C.B. via the connector is achieved by using state of the art components to DIN 41 652.

HARTING offer many solutions. These utilise various combinations of male and female connectors with hoods, featuring either screw locking or latching facilities.

Only 2 examples are shown:

- Continuous security screening and grounding with screw locking and metallized hood.
- Continuous grounding and vibration proof latching system with metallized hood.

Male connector with dimples

Screw locking

Cable with protective screen

Strain relief

Metallized hood

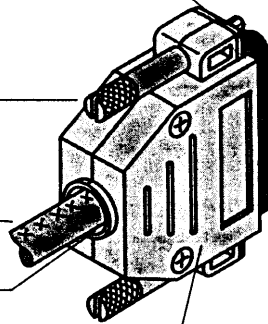

Female connector with tinned protective metal shell



Grounding contact between protective metal shell and P.C. board

Female connector with tinned protective metal shell

Spring latch

Strain relief

Cable with protective screen

Metallized hood

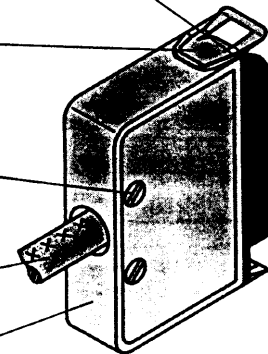

Male connector with dimples

Technical characteristics



Number of contacts 9, 15, 25, 37, 50
UL recognized

Working current

see current carrying capacity chart

Turned contacts 7.5 A max.
Stamped contacts 6.5 A max.
Insulation displacement 2 A max.

Test voltage $U_{r,m,s}$ 1 kV

Clearance and creepage ≥ 1.0 mm
 ≥ 0.7 mm (insulation displacement)

Contact resistance ≤ 10 m Ω

Insulation resistance $\geq 10^{10}$ Ω

Temperature range -55°C + 125°C

The higher temperature limit includes the local ambient and heating effect of the contacts under load

Terminations

- Solder buckets max. 0.5 mm²
- Solder pins \varnothing 0.6 mm for P.C.B. holes \varnothing 0.8/1 mm
- Solder pins, angled 90° \varnothing 0.6 mm for P.C.B. holes \varnothing 1 mm
- Wrap posts 0.6 x 0.6 mm diagonal 0.8-0.86 mm length 13 mm
- Crimp contacts 0.09-0.56 mm² AWG 28-20
- Insulation displacement AWG 28/7 and AWG 26/7 AWG 28/1 and AWG 30/1

Materials

Mouldings and hoods

Thermoplastic resin, glass-fibre filled (PBTP) UL 94-VO

Contacts

Copper alloy
Contact versions
Part No. 09 66 . . .
Male : solid
Female : stamped
Insulation displacement: stamped

Part No. 09 67 0 . . .
Male and Female : turned

Part No. 09 67 2 . . .
Solder buckets
Male and Female : stamped

Part No. 09 68 . . .
Male and Female : stamped

Contact surface¹⁾

Contact zone: selectively gold-plated according to performance level¹⁾
Termination zone: tinned

Metal shell

Steel
Surface
a) tinned
b) zinc-plated and yellow chromated

Insertion and withdrawal force

9 way ≤ 30 N
15 way ≤ 50 N
25 way ≤ 83 N
37 way ≤ 123 N
50 way ≤ 167 N

¹⁾ Performance Level 3 as per DIN 41 652, part 2
 ≥ 50 mating cycles
no gas test

¹⁾ Performance Level 2 as per DIN 41 652, part 2
 ≥ 200 mating cycles
4 day gas test using 10 ppm SO₂

Other performance levels on request

Current carrying capacity

The current carrying capacity is limited by maximum temperature of materials for inserts and contacts including terminals. The current capacity-curve is valid for continuous, not interrupted current-loaded contacts of connectors when simultaneous power on all contacts is given, without exceeding the maximum temperature.

Control and test procedures according to DIN 41 640, part 3.

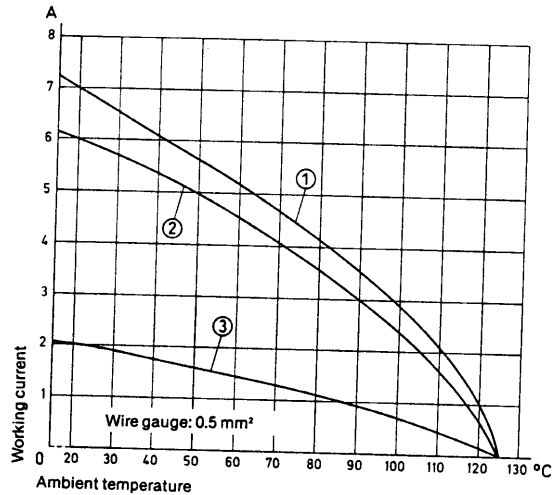

Example: 25 way connector

- Turned contacts
- Stamped contacts
- Insulation displacement contacts

Contact arrangement view from termination side

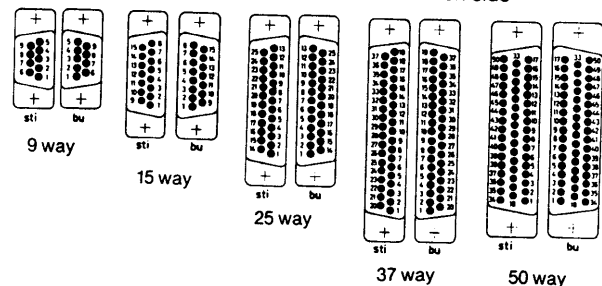

sti = Male connector
bu = Female connector

Mating conditions as per DIN 41 652

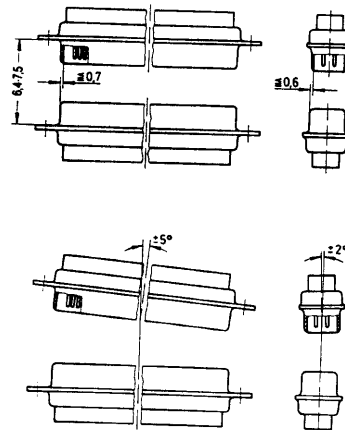



Number of contacts
9-50

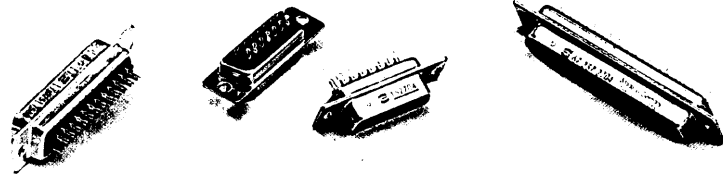

Solder buckets

Identification	No. of contacts	Part No.			
		Performance Level 3	Performance Level 2	Performance Level 3	Performance Level 2
Performance Levels Explanations page 6 Other performance levels on request					
Type of metal shell		tinned Male connector with dimples		yellow chromated	
Male connector - solder buckets		turned contacts	turned contacts	turned contacts	turned contacts
	9	09 67 009 5604	09 67 009 5615	09 67 009 2604	09 67 009 2615
	15	09 67 015 5604	09 67 015 5615	09 67 015 2604	09 67 015 2615
	25	09 67 025 5604	09 67 025 5615	09 67 025 2604	09 67 025 2615
	37	09 67 037 5604	09 67 037 5615	09 67 037 2604	09 67 037 2615
	50	09 67 050 5604*	09 67 050 5615	09 67 050 2604*	09 67 050 2615
		stamped contacts	stamped contacts	stamped contacts	stamped contacts
	9	09 67 209 5604	09 67 209 5615	09 67 209 2604*	09 67 209 2615*
	15	09 67 215 5604	09 67 215 5615	09 67 215 2604*	09 67 215 2615*
	25	09 67 225 5604	09 67 225 5615	09 67 225 2604*	09 67 225 2615*
	37	09 67 237 5604	09 67 237 5615	09 67 237 2604*	09 67 237 2615*
Female connector - solder buckets		turned contacts	turned contacts	turned contacts	turned contacts
	9	09 67 009 4704	09 67 009 4715	09 67 009 2704	09 67 009 2715
	15	09 67 015 4704	09 67 015 4715	09 67 015 2704	09 67 015 2715
	25	09 67 025 4704	09 67 025 4715	09 67 025 2704	09 67 025 2715
	37	09 67 037 4704	09 67 037 4715	09 67 037 2704	09 67 037 2715
	50	09 67 050 4704*	09 67 050 4715	09 67 050 2704*	09 67 050 2715
		stamped contacts	stamped contacts	stamped contacts	stamped contacts
	9	09 67 209 4704	09 67 209 4715	09 67 209 2704*	09 67 209 2715*
	15	09 67 215 4704	09 67 215 4715	09 67 215 2704*	09 67 215 2715*
	25	09 67 225 4704	09 67 225 4715	09 67 225 2704*	09 67 225 2715*
	37	09 67 237 4704	09 67 237 4715	09 67 237 2704*	09 67 237 2715*

Dimensions

Dimensions in mm

Male connector

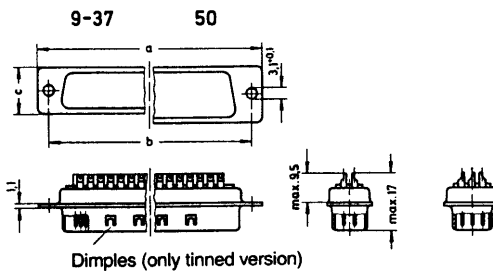

Female connector

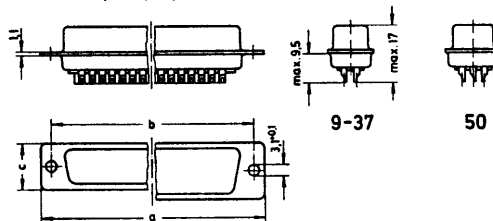

	a	b±0.15	c	d	e
9	30,9	25	12,5	20,5	12
15	39,2	33,3	12,5	28,8	12
25	53,1	47	12,5	42,5	12
37	69,4	63,5	12,5	59,1	12
50	67	61,1	15,4	56,3	14,8

Panel cut out

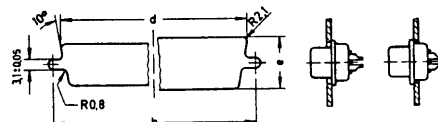

* Not normally kept in stock



Number of contacts

9-50

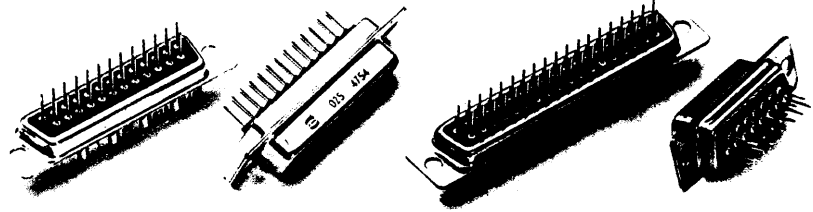

Solder pins, straight

Identification

Performance Levels
 Explanations page 6
 Other performance levels on request

Type of metal shell

Male connector
 - straight solder pins

Female connector
 - straight solder pins

No. of contacts



Part No.

Performance Level 3 Performance Level 2 Performance Level 3 Performance Level 2

tinned
 Male connector with dimples

yellow chromated

turned contacts	turned contacts	turned contacts	turned contacts
09 67 009 5654	09 67 009 5655	09 67 009 2654	09 67 009 2655
09 67 015 5654	09 67 015 5655	09 67 015 2654	09 67 015 2655
09 67 025 5654	09 67 025 5655	09 67 025 2654	09 67 025 2655
09 67 037 5654	09 67 037 5655	09 67 037 2654	09 67 037 2655
09 67 050 5654*	09 67 050 5655	09 67 050 2654*	09 67 050 2655

turned contacts	turned contacts	turned contacts	turned contacts
09 67 009 4754	09 67 009 4755	09 67 009 2754	09 67 009 2755
09 67 015 4754	09 67 015 4755	09 67 015 2754	09 67 015 2755
09 67 025 4754	09 67 025 4755	09 67 025 2754	09 67 025 2755
09 67 037 4754	09 67 037 4755	09 67 037 2754	09 67 037 2755
09 67 050 4754*	09 67 050 4755	09 67 050 2754*	09 67 050 2755

Dimensions

Dimensions in mm

Male connector

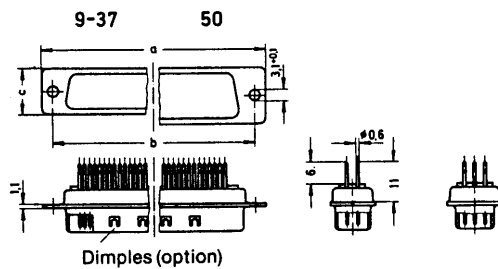

Dimples (option)

Female connector

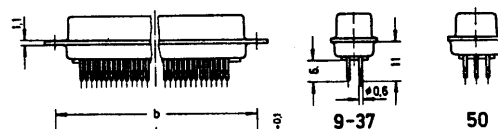

Distance pillar is not supplied

a	b±0.15	c	g	h
9	30,9	25	4 × (2,74) = (10,96)	3 × (2,74) = (8,22)
15	39,2	33,3	7 × (2,74) = (19,18)	6 × (2,74) = (16,44)
25	53,1	47	12 × (2,74) = (33,12)	11 × (2,74) = (30,36)
37	69,4	63,5	18 × (2,74) = (49,68)	17 × (2,74) = (46,92)
50	87	81,1	16 × (2,74) = (44,16)	15 × (2,74) = (41,4)

Board drillings
 straight solder pins

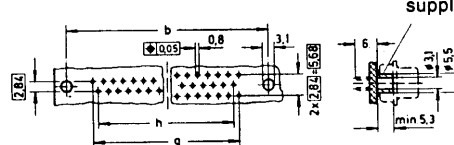



Number of contacts

9-50

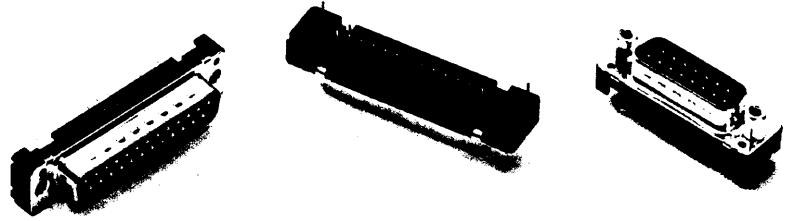

Solder pins, straight - with/without grounding-pins

Identification

Performance Levels

Explanations page 6
Other performance levels on request

Male connector
- straight solder pins
tinned metal shell
and dimples

Female connector
- straight solder pins
tinned metal shell

Please insert digit for
flange thread or fitted
female screw locks

M3 ▶ 1
4-40 UNC ▶ 2
fitted screw locks 4-40 UNC ▶ 3**

No. of contacts



Part No.

Performance Level	3	2
without grounding	09 66 121 770 .	09 66 121 670 .
	09 66 221 770 .	09 66 221 670 .
	09 66 321 770 .	09 66 321 670 .
	09 66 421 770 .	09 66 421 670 .
	09 66 521 770 . *	09 66 521 670 .
with grounding-pins	09 66 161 770 .	09 66 161 670 .
	09 66 261 770 .	09 66 261 670 .
	09 66 361 770 .	09 66 361 670 .
	09 66 461 770 .	09 66 461 670 .
	09 66 561 770 . *	09 66 561 670 .
without grounding	09 66 111 750 .	09 66 111 650 .
	09 66 211 750 .	09 66 211 650 .
	09 66 311 750 .	09 66 311 650 .
	09 66 411 750 .	09 66 411 650 .
	09 66 511 750 . *	09 66 511 650 .
with grounding-pins	09 66 151 750 .	09 66 151 650 .
	09 66 251 750 .	09 66 251 650 .
	09 66 351 750 .	09 66 351 650 .
	09 66 451 750 .	09 66 451 650 .
	09 66 551 750 . *	09 66 551 650 .

Dimensions

Dimensions in mm

Male connector

Female connector

Board drillings
straight solder pins

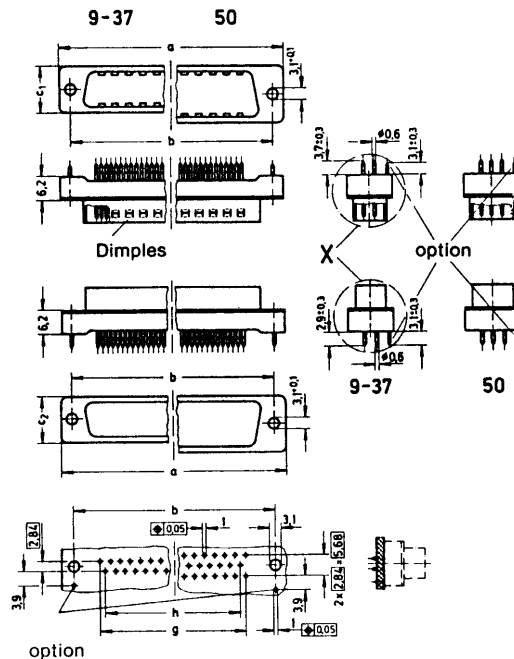

	a	b:01	c1	c2	g	h
9	30,9	25	12,9	12,5	4 x (2,74) - (0,96)	3 x (2,74) - (0,22)
15	39,2	33,3	12,9	12,5	7 x (2,74) - (0,18)	6 x (2,74) - (0,44)
25	53,1	47	12,9	12,5	12 x (2,74) - (0,12)	11 x (2,74) - (0,36)
37	69,4	63,5	12,9	12,5	18 x (2,74) - (0,68)	17 x (2,74) - (0,92)
50	87	81,1	15,7	15,4	16 x (2,74) - (0,16)	15 x (2,74) - (0,14)

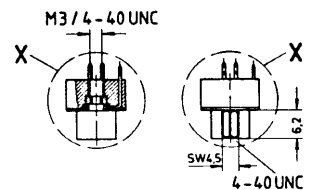

Mating conditions page 6

* Not normally kept in stock
** Fitted screw locks 4-40 UNC not normally kept in stock for performance level 3



Number of contacts

Mounting height

9-37
50

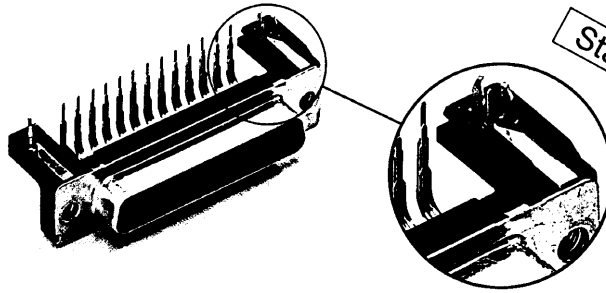
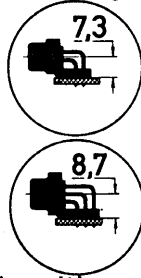

Standard Versions

Solder pins, angled - with snap-in-clips and grounding-pins

Identification

Performance Levels

Explanations page 6
Other performance levels on request

Male connector

- angled solder pins
tinned metal shell
and dimples

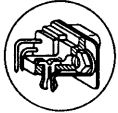

Female connector

- angled solder pins
tinned metal shell

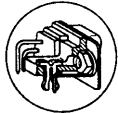

Please insert digit for
flange thread or fitted
female screw locks

- M3 ▶ 1
- 4-40 UNC ▶ 2
- fitted screw locks 4-40 UNC ▶ 3

No. of contacts



Part No.

Performance Level
3

Row separation	2.84 mm
09 66 163 781	.
09 66 263 781	.
09 66 363 781	.
09 66 463 781	.
09 66 563 781	*

Row separation	2.54 mm
09 66 162 781	.
09 66 262 781	.
09 66 362 781	.
09 66 462 781	.
09 66 562 781	*

Row separation	2.84 mm
09 66 153 761	*
09 66 253 761	*
09 66 353 761	*
09 66 453 761	*
09 66 553 761	*

Row separation	2.54 mm
09 66 152 761	.
09 66 252 761	.
09 66 352 761	.
09 66 452 761	.
09 66 552 761	*

Performance Level
2

Row separation	2.84 mm
09 66 163 681	.
09 66 263 681	.
09 66 363 681	.
09 66 463 681	.
09 66 563 681	.

Row separation	2.54 mm
09 66 162 681	.
09 66 262 681	.
09 66 362 681	.
09 66 462 681	.
09 66 562 681	.

Row separation	2.84 mm
09 66 153 661	*
09 66 253 661	*
09 66 353 661	*
09 66 453 661	*
09 66 553 661	*

Row separation	2.54 mm
09 66 152 661	.
09 66 252 661	.
09 66 352 661	.
09 66 452 661	.
09 66 552 661	.

Dimensions

Male connector

Female connector

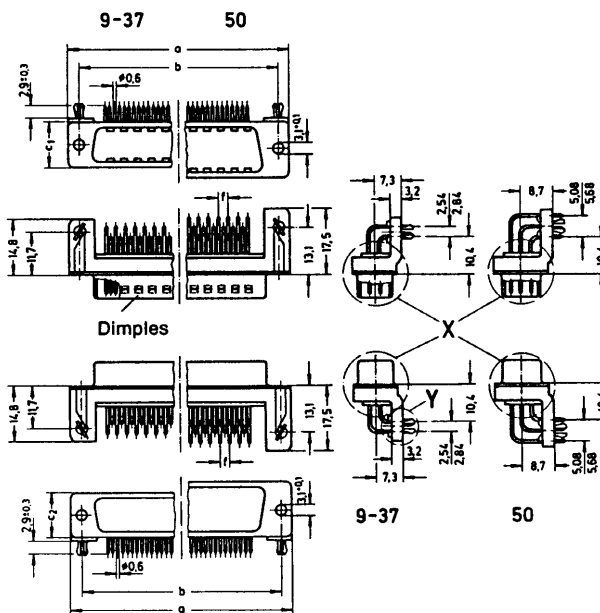

Dimensions in mm

	a	b±0.1	c1	c2	f
9	30.9	25	12.9	12.5	2.74
15	39.2	33.3	12.9	12.5	2.74
25	53.1	47	12.9	12.5	2.76
37	69.4	63.5	12.9	12.5	2.76
50	87	81.1	15.7	15.4	2.76

plated through hole

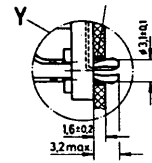

M3 / 4-40 UNC



Mating conditions page 6
Mounting details page 13



D-Sub DIN 41 652 · MIL-C-24 308 · IEC 807

Number of contacts

Mounting height

9-37 50

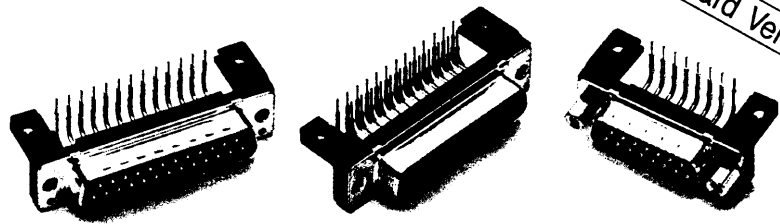
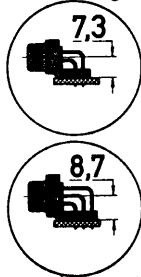

Standard Versions

Solder pins, angled - without grounding

Identification

Performance Levels

Explanations page 6
Other performance levels on request

Male connector

- angled solder pins
tinned metal shell
and dimples

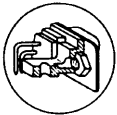

Female connector

- angled solder pins
tinned metal shell

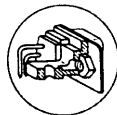

Please insert digit for
flange thread or fitted
female screw locks

M3 ▶ 1

4-40 UNC ▶ 2

fitted screw locks 4-40 UNC ▶ 3

No. of contacts



Part No.

Performance Level
3

Row separation 2.84 mm
 09 66 123 780 .
 09 66 223 780 .
 09 66 323 780 .
 09 66 423 780 .
 09 66 523 780 . *

Row separation 2.54 mm
 09 66 122 780 .
 09 66 222 780 .
 09 66 322 780 .
 09 66 422 780 .
 09 66 522 780 . *

Row separation 2.84 mm
 09 66 113 760 . *
 09 66 213 760 . *
 09 66 313 760 . *
 09 66 413 760 . *
 09 66 513 760 . *

Row separation 2.54 mm
 09 66 112 760 .
 09 66 212 760 .
 09 66 312 760 .
 09 66 412 760 .
 09 66 512 760 . *

Performance Level
2

Row separation 2.84 mm
 09 66 123 680 .
 09 66 223 680 .
 09 66 323 680 .
 09 66 423 680 .
 09 66 523 680 .

Row separation 2.54 mm
 09 66 122 680 .
 09 66 222 680 .
 09 66 322 680 .
 09 66 422 680 .
 09 66 522 680 .

Row separation 2.84 mm
 09 66 113 660 . *
 09 66 213 660 . *
 09 66 313 660 . *
 09 66 413 660 . *
 09 66 513 660 . *

Row separation 2.54 mm
 09 66 112 660 .
 09 66 212 660 .
 09 66 312 660 .
 09 66 412 660 .
 09 66 512 660 .

Dimensions

Dimensions in mm

Male connector

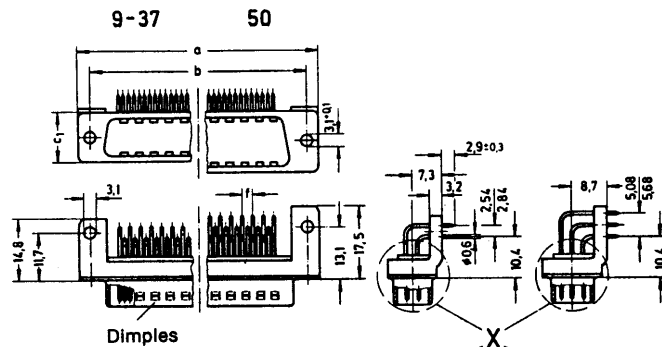

Female connector

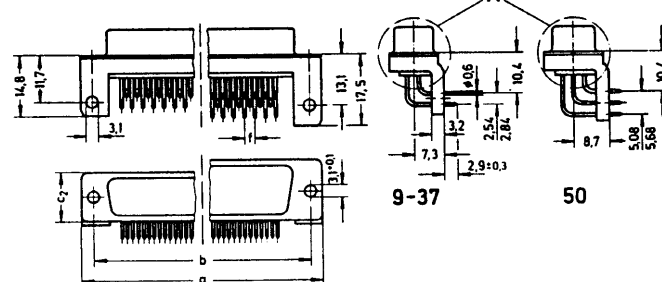

	a	b±0.1	c ₁	c ₂	f
9	30.9	25	12.9	12.5	2.74
15	39.2	33.3	12.9	12.5	2.74
25	53.1	47	12.9	12.5	2.76
37	69.4	63.5	12.9	12.5	2.76
50	67	61.1	15.7	15.4	2.76

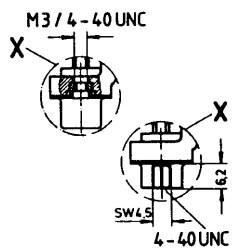

Mating conditions page 6
Mounting details page 13

* Not normally kept in stock

D-Sub

Number of contacts

9-37

Mounting height

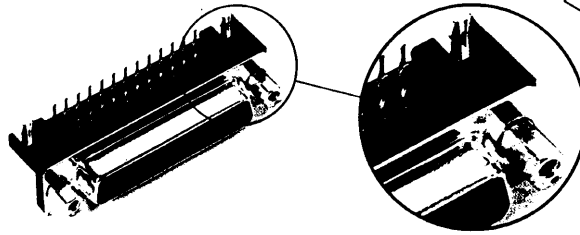
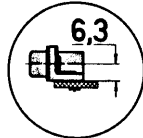

U.S. Footprint



Solder pins, angled - with snap-in-clips and grounding-pins

Identification	No. of contacts	Part. No.
Performance Levels Explanations page 6		Performance Level 3 Performance Level $\geq 0.76 \mu\text{m Au}$ (30 μinch)
Male connector - angled solder pins tinned metal shell and dimples	9 15 25 37	09 68 163 781 . 09 68 263 781 . 09 68 363 781 . 09 68 463 781 .
Female connector - angled solder pins tinned metal shell	9 15 25 37	09 68 153 761 . 09 68 253 761 . 09 68 353 761 . 09 68 453 761 .
Please insert digit for flange thread or fitted female screw locks	4-40 UNC ▶ 2 fitted screw locks 4-40 UNC ▶ 3	

Dimensions

Male connector

Female connector

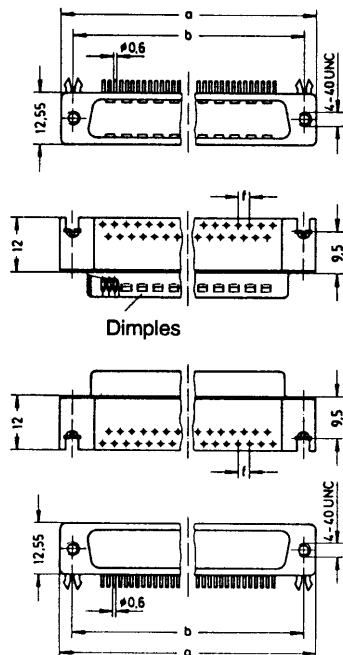

Dimensions in mm

	a	b±0.1	f
9	30.9	25.0	2.74
15	39.2	33.3	2.74
25	53.1	47.0	2.77
37	69.4	63.5	2.77

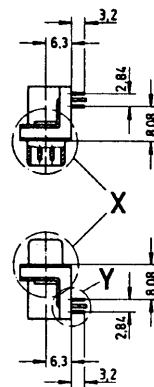

Y plated through hole

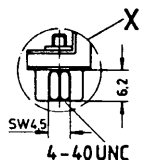
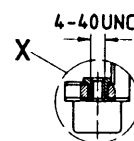
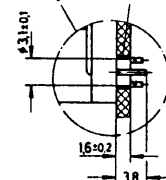

Mating conditions page 6
Mounting details page 13

Identification

Drawing

Dimensions in mm

Standard Versions

Mounting height 7.3 mm

9-37 way
for front panel
4 units of width (TE)

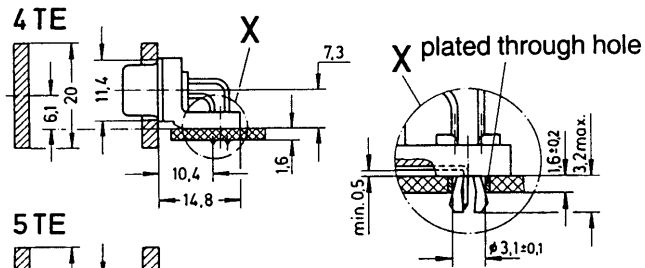

Mounting height 8.7 mm

50 way
for front panel
5 units of width (TE)

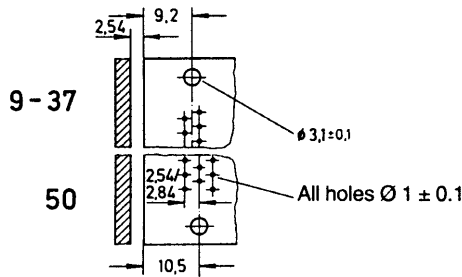
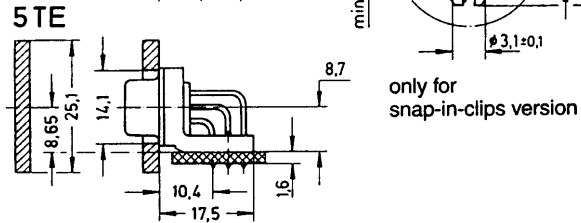

for connectors page 10, 11

U.S. Footprint Versions

Mounting height 6.3 mm

9-37 way
for front panel
4 units of width (TE)

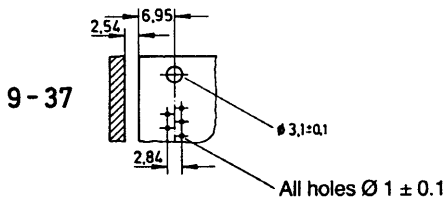
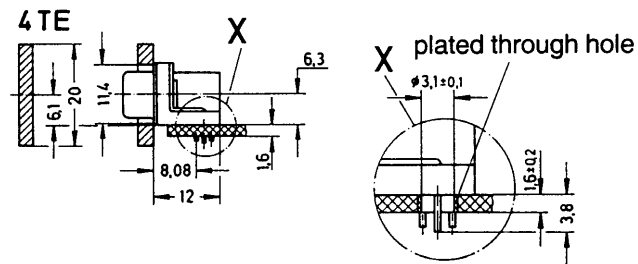

for connectors page 12

Panel cut out
for front panel

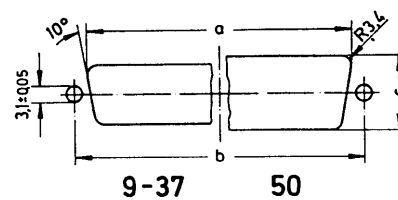

	a	b±0,1	c
9	20,5	25,0	11,4
15	28,8	33,3	11,4
25	42,5	47,0	11,4
37	59,1	63,5	11,4
50	56,3	61,1	14,1



Original Versions

Number of contacts

9-50



Solder pins, angled - without fixing bracket

Identification	No. of contacts	Part No.			
		Performance Level 3	Performance Level 2	Performance Level 3	Performance Level 2
Performance Levels Explanations page 6 Other performance levels on request					
Type of metal shell		tinned Male connector with dimples		yellow chromated	
Male connector - angled solder pins		Row separation 2.84 mm	Row separation 2.84 mm	Row separation 2.84 mm	Row separation 2.84 mm
	9	09 67 009 5663	09 67 009 5664	09 67 009 2663	09 67 009 2664
	15	09 67 015 5663	09 67 015 5664	09 67 015 2663	09 67 015 2664
	25	09 67 025 5663	09 67 025 5664	09 67 025 2663	09 67 025 2664
	37	09 67 037 5663	09 67 037 5664	09 67 037 2663	09 67 037 2664
	50	09 67 050 5663*	09 67 050 5664	09 67 050 2663*	09 67 050 2664
	9	Row separation 2.54 mm	Row separation 2.54 mm	Row separation 2.54 mm	Row separation 2.54 mm
	15	09 67 009 5657*	09 67 009 5658*	09 67 009 2657*	09 67 009 2658*
	25	09 67 015 5657*	09 67 015 5658*	09 67 015 2657*	09 67 015 2658*
	37	09 67 025 5657*	09 67 025 5658*	09 67 025 2657*	09 67 025 2658*
	50	09 67 037 5657*	09 67 037 5658*	09 67 037 2657*	09 67 037 2658*
	50	09 67 050 5657*	09 67 050 5658*	09 67 050 2657*	09 67 050 2658*
Female connector - angled solder pins		Row separation 2.84 mm	Row separation 2.84 mm	Row separation 2.84 mm	Row separation 2.84 mm
	9	09 67 009 4763	09 67 009 4764	09 67 009 2763	09 67 009 2764
	15	09 67 015 4763	09 67 015 4764	09 67 015 2763	09 67 015 2764
	25	09 67 025 4763	09 67 025 4764	09 67 025 2763	09 67 025 2764
	37	09 67 037 4763	09 67 037 4764	09 67 037 2763	09 67 037 2764
	50	09 67 050 4763*	09 67 050 4764	09 67 050 2763	09 67 050 2764
	9	Row separation 2.54 mm	Row separation 2.54 mm	Row separation 2.54 mm	Row separation 2.54 mm
	15	09 67 009 4757*	09 67 009 4758*	09 67 009 2757*	09 67 009 2758*
	25	09 67 015 4757*	09 67 015 4758*	09 67 015 2757*	09 67 015 2758*
	37	09 67 025 4757*	09 67 025 4758*	09 67 025 2757*	09 67 025 2758*
	50	09 67 037 4757*	09 67 037 4758*	09 67 037 2757*	09 67 037 2758*
	50	09 67 050 4757*	09 67 050 4758*	09 67 050 2757*	09 67 050 2758*

Dimensions

Male connector

Female connector

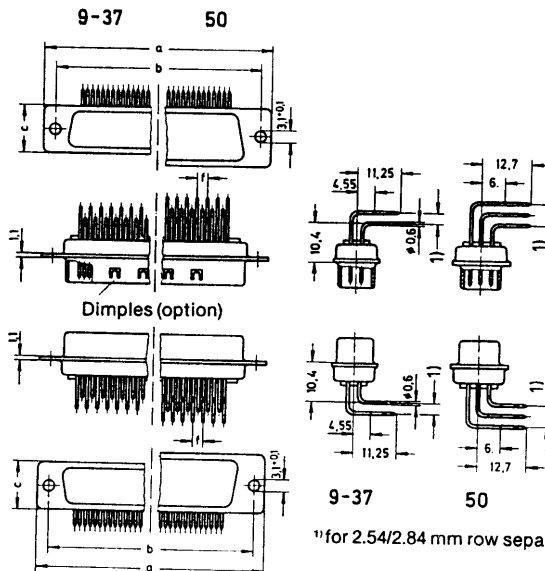

	a	b±0,15	c	f
9	30,9	25	12,5	2,74
15	39,2	33,3	12,5	2,74
25	53,1	47	12,5	2,76
37	69,4	63,5	12,5	2,76
50	87	61,1	15,4	2,76

Mating conditions page 6
Accessories page 15

* Not normally kept in stock

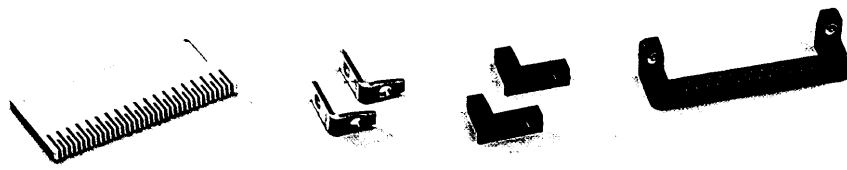

Accessories

Identification	No. of contacts	Part No.	Drawing	Dimensions in mm																																				
Mounting comb for alignment of floating angled solder pins	9-50	09 99 000 0097																																						
Fixing bracket Metal bracket	9-37 50	09 67 000 9910 ¹⁾ 09 67 000 9911 ¹⁾	 <table border="1"> <tr><td></td><td>a</td><td>b</td></tr> <tr><td>9-37</td><td>10,8</td><td>6,5</td></tr> <tr><td>50</td><td>12,2</td><td>8</td></tr> </table>		a	b	9-37	10,8	6,5	50	12,2	8																												
		a	b																																					
9-37	10,8	6,5																																						
50	12,2	8																																						
Plastic bracket ¹⁾ order 2 per connector ¹⁾	9-50	09 67 000 9913 ¹⁾	 <table border="1"> <tr><td></td><td>a</td><td>b</td></tr> <tr><td>9-37</td><td>10,8</td><td>6,5</td></tr> <tr><td>50</td><td>12,2</td><td>8</td></tr> </table>		a	b	9-37	10,8	6,5	50	12,2	8																												
		a	b																																					
9-37	10,8	6,5																																						
50	12,2	8																																						
Mounting bracket for row separation 2.54/2.84 mm threaded flange M 3	9 15 25 37 50	09 67 000 9935 09 67 000 9997 09 67 000 9998 09 67 000 9938 09 67 000 9939 ²⁾	 M3/4 - 40 UNC																																					
	9 15 25 37 50	09 67 000 9987 09 67 000 9988 09 67 000 9989 09 67 000 9990 09 67 000 9991 ²⁾	<table border="1"> <tr><td></td><td>b</td><td>c</td><td>d</td><td>e</td><td>f</td></tr> <tr><td>9</td><td>25</td><td>12</td><td>7,3^{-0,2}</td><td>16,7</td><td>2,74</td></tr> <tr><td>15</td><td>33,3</td><td>12</td><td>7,3^{-0,2}</td><td>16,7</td><td>2,74</td></tr> <tr><td>25</td><td>47</td><td>12</td><td>7,3^{-0,2}</td><td>16,7</td><td>2,76</td></tr> <tr><td>37</td><td>63,5</td><td>12</td><td>7,3^{-0,2}</td><td>16,7</td><td>2,76</td></tr> <tr><td>50</td><td>61,1</td><td>13,5</td><td>8,7^{-0,2}</td><td>17</td><td>2,76</td></tr> </table>		b	c	d	e	f	9	25	12	7,3 ^{-0,2}	16,7	2,74	15	33,3	12	7,3 ^{-0,2}	16,7	2,74	25	47	12	7,3 ^{-0,2}	16,7	2,76	37	63,5	12	7,3 ^{-0,2}	16,7	2,76	50	61,1	13,5	8,7 ^{-0,2}	17	2,76	³⁾ for 2.54/2.84 mm row separation
		b	c	d	e	f																																		
	9	25	12	7,3 ^{-0,2}	16,7	2,74																																		
	15	33,3	12	7,3 ^{-0,2}	16,7	2,74																																		
25	47	12	7,3 ^{-0,2}	16,7	2,76																																			
37	63,5	12	7,3 ^{-0,2}	16,7	2,76																																			
50	61,1	13,5	8,7 ^{-0,2}	17	2,76																																			
Mounting height			 <table border="1"> <tr><td></td><td>b</td><td>g</td><td>h</td></tr> <tr><td>9</td><td>25</td><td>4x(2,74) = 10,96</td><td>3x(2,74) = 8,22</td></tr> <tr><td>15</td><td>33,3</td><td>7x(2,74) = 19,18</td><td>6x(2,74) = 16,44</td></tr> <tr><td>25</td><td>47</td><td>12x(2,76) = 33,12</td><td>11x(2,76) = 30,36</td></tr> <tr><td>37</td><td>63,5</td><td>18x(2,76) = 49,68</td><td>17x(2,76) = 46,92</td></tr> </table>		b	g	h	9	25	4x(2,74) = 10,96	3x(2,74) = 8,22	15	33,3	7x(2,74) = 19,18	6x(2,74) = 16,44	25	47	12x(2,76) = 33,12	11x(2,76) = 30,36	37	63,5	18x(2,76) = 49,68	17x(2,76) = 46,92	Mounting height																
	b	g	h																																					
9	25	4x(2,74) = 10,96	3x(2,74) = 8,22																																					
15	33,3	7x(2,74) = 19,18	6x(2,74) = 16,44																																					
25	47	12x(2,76) = 33,12	11x(2,76) = 30,36																																					
37	63,5	18x(2,76) = 49,68	17x(2,76) = 46,92																																					
Mounting height		 <table border="1"> <tr><td></td><td>f</td></tr> <tr><td>09 67 000 9911</td><td>13,2</td></tr> <tr><td>09 67 000 9913</td><td>13,2</td></tr> <tr><td>Mounting bracket</td><td>12,95</td></tr> </table>		f	09 67 000 9911	13,2	09 67 000 9913	13,2	Mounting bracket	12,95	Mounting height																													
	f																																							
09 67 000 9911	13,2																																							
09 67 000 9913	13,2																																							
Mounting bracket	12,95																																							

⁴⁾Not in conjunction with mounting bracket



Number of contacts

9-50

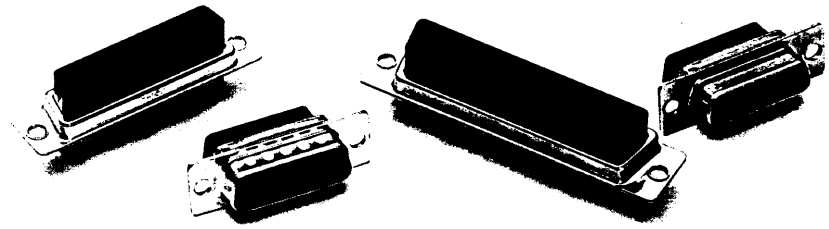

Crimp terminal

Identification

Type of metal shell

Male connector for crimp contacts
Order contacts separately

Female connector for crimp contacts
Order contacts separately

No. of contacts

Part No.

tinned

yellow chromated

with dimples

without dimples



09 67 009 5601
09 67 015 5601
09 67 025 5601
09 67 037 5601
09 67 050 5601

09 67 009 3001
09 67 015 3001
09 67 025 3001
09 67 037 3001
09 67 050 3001

09 67 009 4701
09 67 015 4701
09 67 025 4701
09 67 037 4701
09 67 050 4701

09 67 009 3101
09 67 015 3101
09 67 025 3101
09 67 037 3101
09 67 050 3101

Dimensions

Dimensions in mm

Male connector

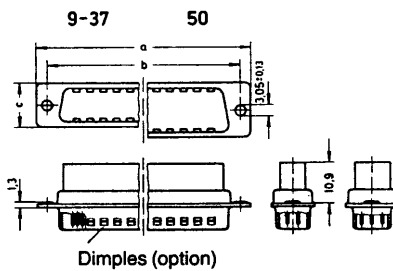

Female connector

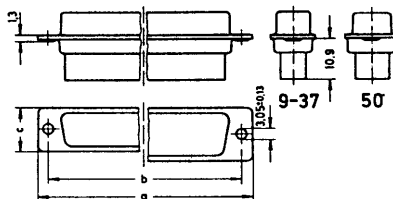

	a	b±0,05	c	d	e
9	30,9	25	12,5	20,5	12
15	39,2	33,3	12,5	28,8	12
25	53,1	47	12,5	42,5	12
37	69,4	63,5	12,5	59,1	12
50	67	61,1	15,4	56,3	14,8

Panel cut out

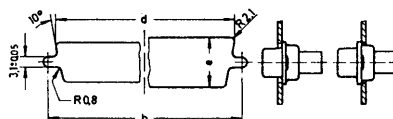

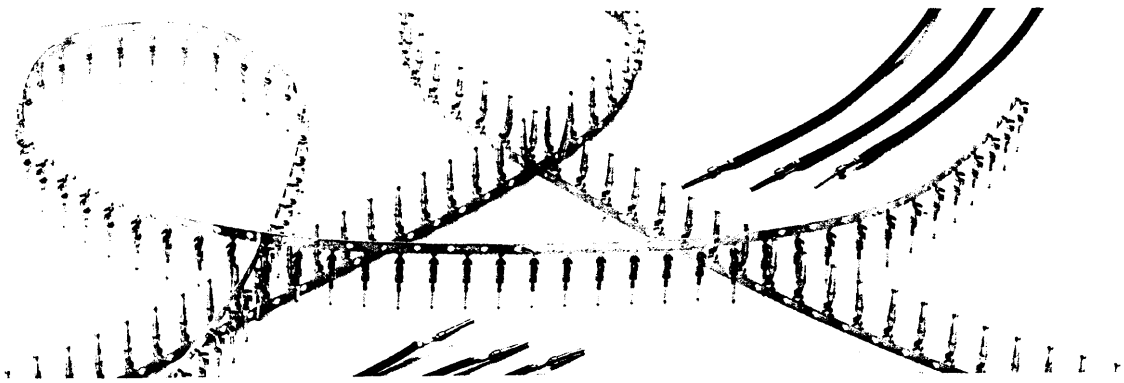

Crimp contacts

Identification	Wire gauge (mm ²)	stamped male contacts		stamped female contacts	
		Performance level 3	Performance level 2	Performance level 3	Performance level 2
Performance Levels Explanations page 6 Other performance levels on request	▶				
Individual contacts	0.09-0.25 AWG 28-24 ²⁾	09 67 000 7177 ¹⁾	09 67 000 7178 ¹⁾	09 67 000 7277 ¹⁾	09 67 000 7278 ¹⁾
500 pieces/reel Unrolling left		09 67 000 7167	09 67 000 7168	09 67 000 7267	09 67 000 7268
10000 pieces/reel Unrolling left Unrolling left reversed Unrolling right reversed		09 67 000 7157 09 67 000 7147 09 67 000 7137	09 67 000 7158 09 67 000 7148 09 67 000 7138	09 67 000 7257 09 67 000 7247 09 67 000 7237	09 67 000 7258 09 67 000 7248 09 67 000 7238
2) contact identification: ==					
Individual contacts	0.25-0.56 AWG 24-20 ³⁾	09 67 000 8177 ¹⁾	09 67 000 8178 ¹⁾	09 67 000 8277 ¹⁾	09 67 000 8278 ¹⁾
500 pieces/reel Unrolling left		09 67 000 8167	09 67 000 8168	09 67 000 8267	09 67 000 8268
10000 pieces/reel Unrolling left Unrolling left reversed Unrolling right reversed		09 67 000 8157 09 67 000 8147 09 67 000 8137	09 67 000 8158 09 67 000 8148 09 67 000 8138	09 67 000 8257 09 67 000 8247 09 67 000 8237	09 67 000 8258 09 67 000 8248 09 67 000 8238

3) contact identification: —

Unrolling direction

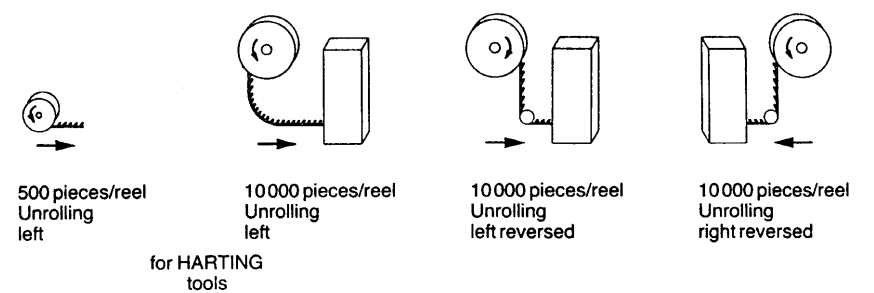

Stripping length: 2.5 + 0.5 mm
Max. insulation diameter: 1.7 mm
Insertion/Removal: page 18

¹⁾ Minimum order 500 pieces or multiples of 500

D-Sub

Tools for crimp termination

Identification Part No.
 Service crimp tool
 for single contacts 09 99 000 0175



HARTING-
 Crimp tool
 for 500
 bandoliered contacts 09 99 000 0169



HARTING
 Semi-automatic
 crimping device
 Main drive,
 foot-operated
 220 V/50 Hz 09 99 000 0246

Crimping head for
 bandoliered contacts
 (500 contacts) 09 99 000 0253

Wire gauge
 0.09–0.56 mm² (AWG 28–20)

Reel holder for
 10000 contacts 09 99 000 0158



Automatic BK
 Crimp machine
 Electric press 09 98 000 2000

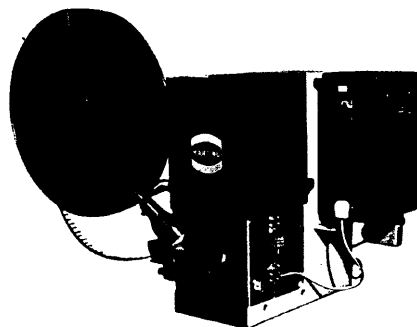

Crimp tool 09 98 000 2008
 09 98 000 2009

Wire gauge
 0.09–0.25 mm² (AWG 28–24)
 0.25–0.56 mm² (AWG 24–20)

Insertion and
 removal tool 09 99 000 0171

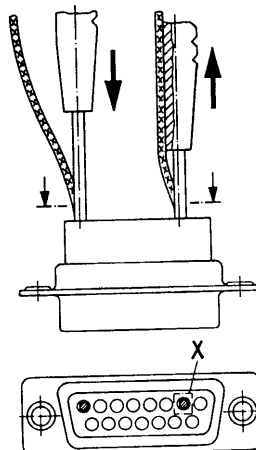

Assembly of crimp contacts

After crimping the stranded wire to the contact using a hand tool or automatic crimping device, insert the contacts into the chambers with the tool, working from the wiring side. You will hear the contacts snap home and to check that they are securely in place, give the wire a gentle pull.

Removing crimp contacts

Position the tool from the wiring side as shown in the diagram below and insert into the contact chamber. The contact can then easily be removed from the wiring side together with the wire itself and replaced in a different chamber. The tool is designed for a maximum insulation diameter of $\varnothing 1.7$ mm.



Stripping length: 2.5 + 0.5 mm

Number of contacts

9-50

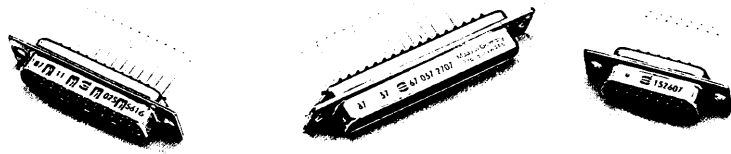

Wrap posts 0.6 x 0.6 mm

Identification	No. of contacts	Part No.			
		Performance Level 3	Performance Level 2	Performance Level 3	Performance Level 2
Performance Levels Explanations page 6 Other performance levels on request					
Type of metal shell		tinned Male connector with dimples		yellow chromated	
Male connector - wrap posts	9 15 25 37 50	09 67 009 5607 09 67 015 5607 09 67 025 5607 09 67 037 5607 09 67 050 5607	09 67 009 5616* 09 67 015 5616* 09 67 025 5616* 09 67 037 5616* 09 67 050 5616*	09 67 009 2607 09 67 015 2607 09 67 025 2607 09 67 037 2607 09 67 050 2607	09 67 009 2616* 09 67 015 2616* 09 67 025 2616* 09 67 037 2616* 09 67 050 2616*
Female connector - wrap posts	9 15 25 37 50	09 67 009 4707 09 67 015 4707 09 67 025 4707 09 67 037 4707 09 67 050 4707	09 67 009 4716* 09 67 015 4716* 09 67 025 4716* 09 67 037 4716* 09 67 050 4716*	09 67 009 2707 09 67 015 2707 09 67 025 2707 09 67 037 2707 09 67 050 2707	09 67 009 2716* 09 67 015 2716* 09 67 025 2716* 09 67 037 2716* 09 67 050 2716*

Dimensions

Dimensions in mm

Male connector

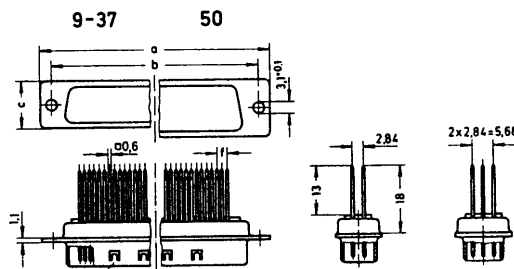

Female connector

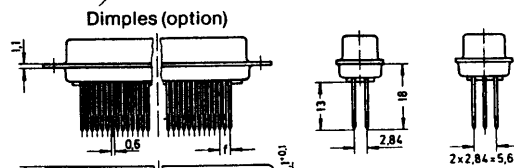

	a	b±0.15	c	d	e	f
9	30,9	25	12,5	20,5	12	2,74
15	39,2	33,3	12,5	28,8	12	2,74
25	53,1	47	12,5	42,5	12	2,76
37	69,4	63,5	12,5	58,1	12	2,76
50	87	81,1	15,4	86,3	14,8	2,76

Panel cut out

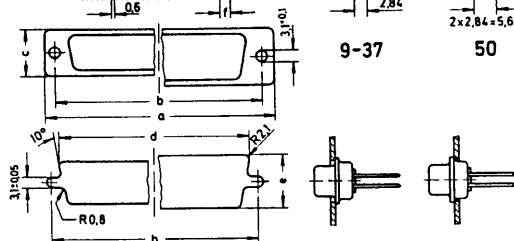

* Not normally kept in stock



Number of contacts

9-37

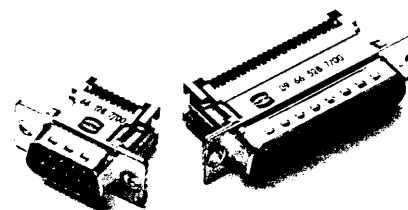
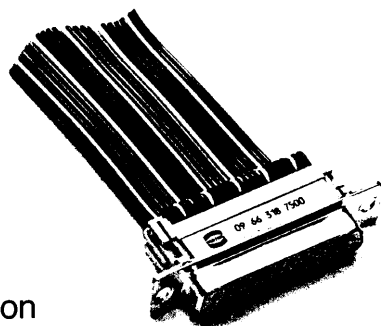

Insulation displacement termination

Identification	No. of contacts	Part No.	Performance level
Performance Levels Explanations page 6 Other performance levels on request			3
Male connector - insulation displacement termination pitch 1.27 mm tinned metal shell and dimples	9	09 66 128 7700	* 09 66 128 6700
	15	09 66 228 7700	09 66 228 6700
	25	09 66 328 7700	09 66 328 6700
	37	09 66 428 7700	09 66 428 6700
Female connector - insulation displacement termination pitch 1.27 mm tinned metal shell	9	09 66 118 7500	09 66 118 6500
	15	09 66 218 7500	09 66 218 6500
	25	09 66 318 7500	09 66 318 6500
	37	09 66 418 7500	09 66 418 6500
Strain relief clamp corrosion resistant steel for male and female connectors	9	09 66 108 0000	09 66 108 0000
	15	09 66 208 0000	09 66 208 0000
	25	09 66 308 0000	09 66 308 0000
	37	09 66 408 0000	09 66 408 0000

Dimensions

Dimensions in mm

Male connector

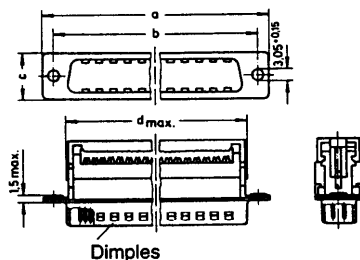

	a-0,76	b	c-0,76	d
9	31,19	25	12,93	18,6
15	39,52	33,3	12,93	26,9
25	53,42	47	12,93	40,6
37	69,7	63,5	12,93	57,1

Female connector

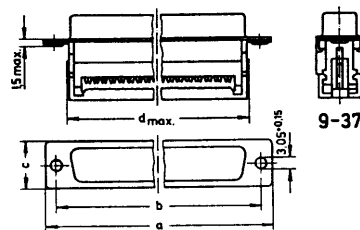

Specified conductors
stranded wires AWG 28/7
AWG 26/7
solid wires AWG 30/1
AWG 28/1

Strain relief clamp

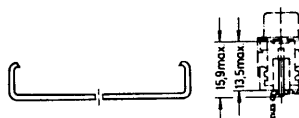

D-Sub

Cables and tools

Identification

Part No.

Dimensions in mm

Flat cable AWG 28/7

9 way	09 18 009 700 . *
15 way	09 18 015 700 . *
25 way	09 18 025 700 .
37 way	09 18 037 700 .

grey	30.48 m	3
grey	152.40 m	4
colour coded	30.48 m	5

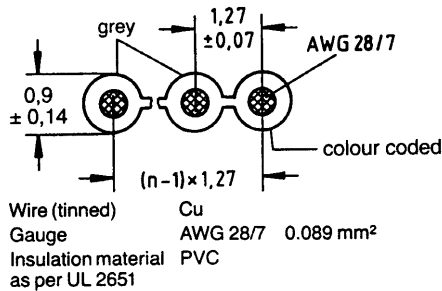

Important:
always store reels vertically

Round flat cable AWG 28/7

9 way	09 18 009 700 .
15 way	09 18 015 700 .
25 way	09 18 025 700 .
37 way	09 18 037 700 .

with screening	7
without screening	8

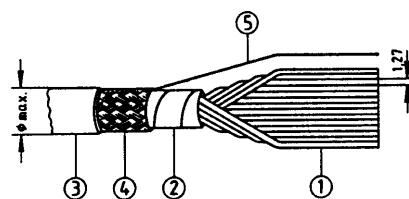

Part No.	No. of contacts*			
	Ø max.			
09 18 ... 7007	9	15	25	37
09 18 ... 7008	7,7	8,6	9,7	10,6

*Others sizes on request

Length per reel 30.48 m (100 feet)

- ① Flat cable, grey AWG 28/7
- ② Barrier tape
- ③ Outer insulation PVC, grey
- ④ Tinned copper screen (shielded version)
- ⑤ Drain Wire AWG 28 (shielded version)

Cable cutter for flat cables

09 99 000 0116

Spare parts

Blade	09 99 000 0179
Cutting plate	09 99 000 0180

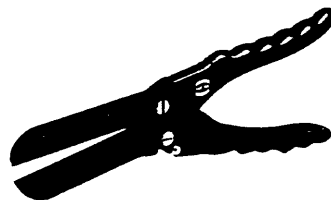

Bench press

for termination of insulation displacement connectors and assembly of hoods

09 99 000 0114

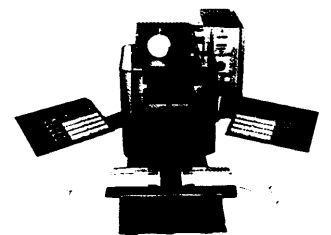

Base plate

for termination of flat cables

09 99 000 0135

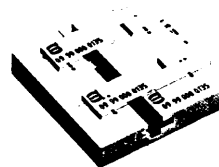
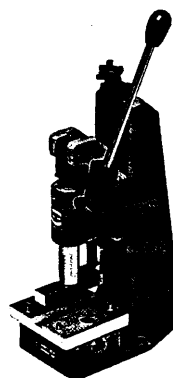

Harnessing work station and test equipment for flat cable assembly available on request.

Hand tool with base plates (included in tool kit)

for termination of insulation displacement connectors

09 99 000 0149

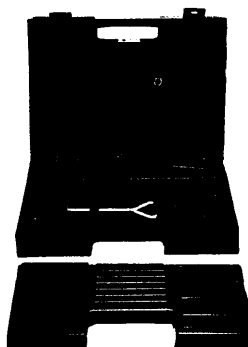

* Not available in colour coded version

D-Sub



Connector hoods for screw locking

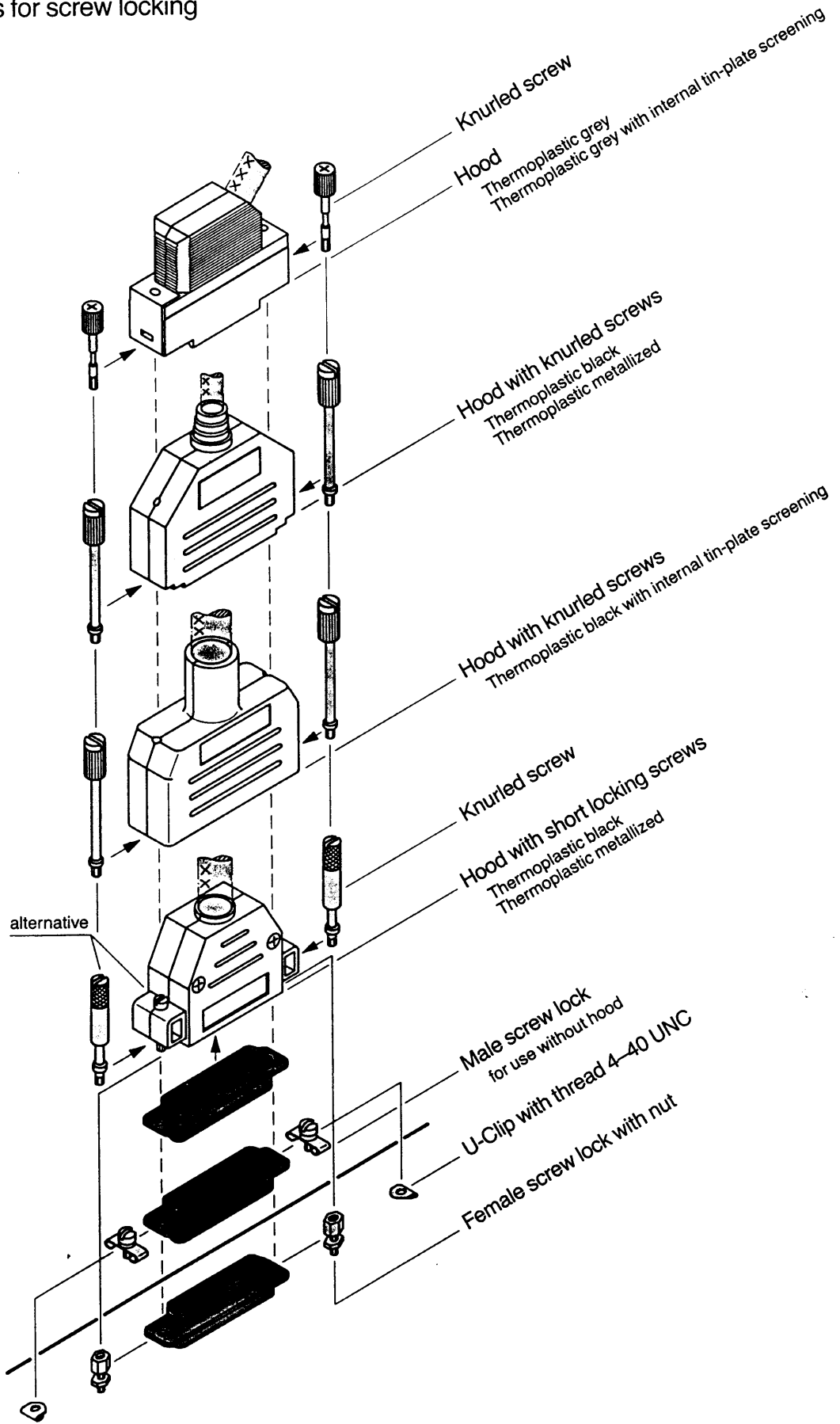

D-Sub

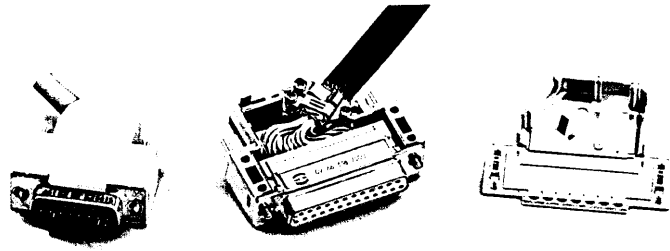

Hoods for screw locking, accessories and tooling

Identification	No. of contacts	Part No.	Drawing	Dimensions in mm																									
Hood¹⁾																													
Thermoplastic grey	9	09 67 009 0571																											
	15	09 67 015 0571																											
	25	09 67 025 0571																											
	37	09 67 037 0571																											
	50	09 67 050 0571																											
Thermoplastic grey with internal tin-plate screening	9	09 67 009 0573		<table border="1"> <thead> <tr> <th></th> <th>a max.</th> <th>b</th> <th>c</th> <th>d max.</th> </tr> </thead> <tbody> <tr> <td>15</td> <td>39.62</td> <td>33.3</td> <td>15</td> <td>Ø9</td> </tr> <tr> <td>25</td> <td>53.52</td> <td>47</td> <td>15</td> <td>Ø11</td> </tr> <tr> <td>37</td> <td>69.8</td> <td>63.5</td> <td>15</td> <td>Ø11</td> </tr> <tr> <td>50</td> <td>67.41</td> <td>61.1</td> <td>19</td> <td>Ø14.5</td> </tr> </tbody> </table>		a max.	b	c	d max.	15	39.62	33.3	15	Ø9	25	53.52	47	15	Ø11	37	69.8	63.5	15	Ø11	50	67.41	61.1	19	Ø14.5
		a max.			b	c	d max.																						
	15	39.62			33.3	15	Ø9																						
	25	53.52			47	15	Ø11																						
	37	69.8			63.5	15	Ø11																						
50	67.41	61.1	19	Ø14.5																									
15	09 67 015 0573																												
25	09 67 025 0573																												
37	09 67 037 0573																												
50	09 67 050 0573																												
9-37 way for packaging density of 3 TE (15.24 mm)																													
Knurled screw for hoods																													
⁴⁾ 9 way 1 per hood 15-50 way 2 per hood	9-50	09 67 000 9971 ⁴⁾																											
²⁾ Before assembling the hood, the knurled screws must be inserted into the lower hood part. ³⁾ For retained nut when using slide lock or female screw lock.																													
Bench press for assembly of hoods and termination of insulation displacement connectors		09 99 000 0114																											
Tooling for assembly of hoods																													
Top part		09 99 000 0215*																											
Bottom part		09 99 000 0216*																											

¹⁾ Order knurled screw separately
* Not normally kept in stock

D-Sub

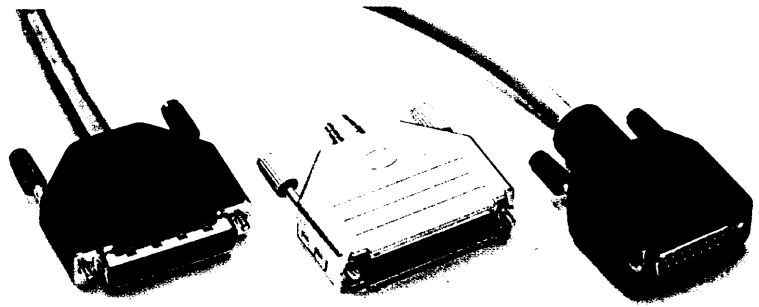

Hoods with knurled screws

Identification No. of contacts Part No. Drawing Dimensions in mm

Hood

Thermoplastic black

9
15
25
37
50

09 67 009 0424
09 67 015 0424
09 67 025 0424
09 67 037 0424
09 67 050 0424

Drawing

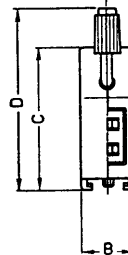
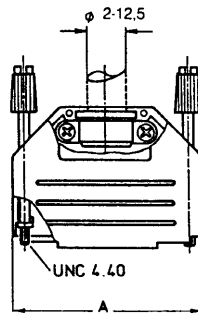

	A	B	C	D
9	31,5	15	34	4,9
15	40	15	34	4,9
25	53,5	15	40	4,9
37	71	16	40	4,9
50	67,5	19	40	4,9

Hood

Thermoplastic metallized

9
15
25
37
50

09 67 009 0425
09 67 015 0425
09 67 025 0425
09 67 037 0425
on request

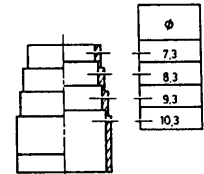
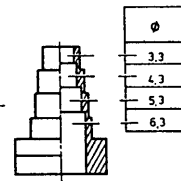
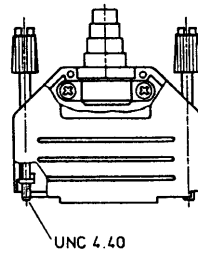

Cut appropriate cable entry to fit actual cable diameter

Hood screened*

Thermoplastic black

9
15
25
37
50

09 67 009 0422
09 67 015 0422
09 67 025 0422
09 67 037 0422
on request

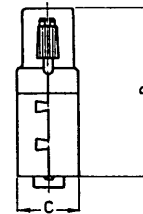
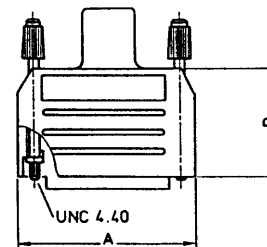

	A	B	C	D
9	35	54	19,1	3,4
15	43	54	19,1	3,4
25	57,5	54	19,1	3,4
37	74	54	19,1	3,4

Internal metal screen

9
15
25
37
50

09 67 009 0421
09 67 015 0421
09 67 025 0421
09 67 037 0421
on request

	Ø (mm)	
	min.	max.
9	6,1	8,8
15	6,1	8,8
25	8,0	10,3
37	9,5	11,5

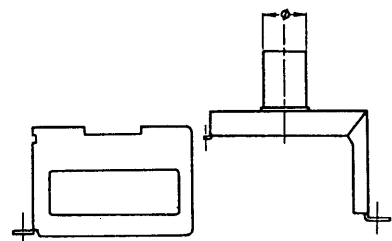

*order both parts

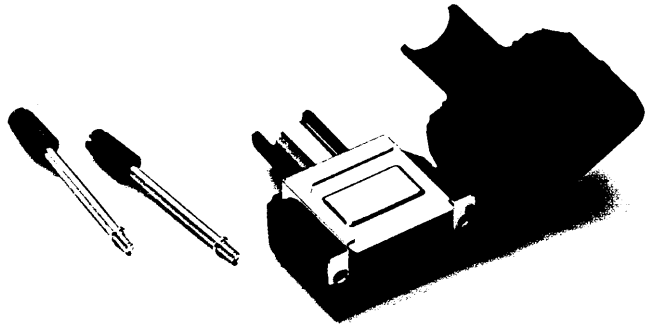

Tool / Assembly instructions

Identification	No. of contacts	Part No.	Drawing	Dimensions in mm
Crimp tool for screened hoods		09 99 000 0233		
Crimp tool dies	8	09 99 000 0235		
	15	09 99 000 0236		
	25	09 99 000 0237		

Assembly instructions for screened hoods

Place the metal screen part (A) on the cable.
Prepare the cable for termination.

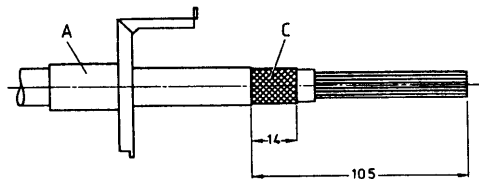

Place the inner ferrule (B) between conductors and the outer braid (C).

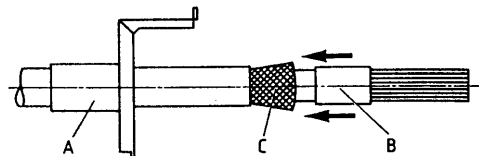

Terminate the D-Sub connector.
Put the metal screen part (A) over the braid and crimp directly over the inner ferrule, ensuring that the correct crimp tool die is used.
Slide in the other metal screen part (D).

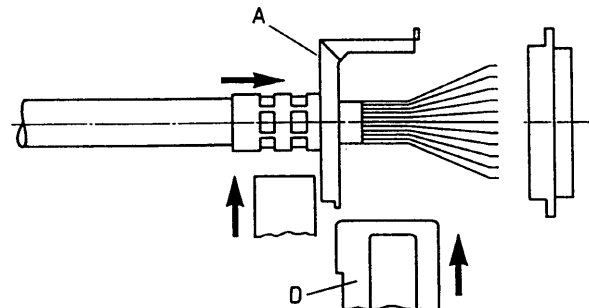

Push back the terminated connector into the assembled screen.
Put the assembled connector, screen and knurled screws into the thermoplastic hood and snap closed.

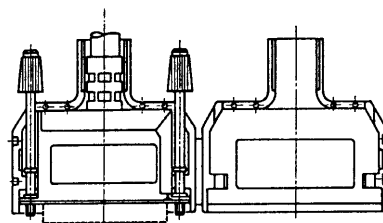

D-Sub

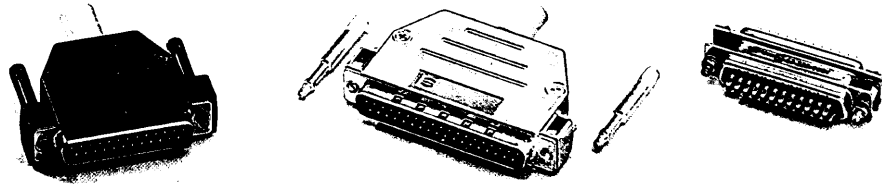

Hoods with screw locks and accessories

Identification	No. of contacts	Part. No.	Drawing	Dimensions in mm																																								
Hood with short locking screws	9 15 25 37 50	Thermoplastic black*		<table border="1"> <thead> <tr> <th></th> <th>a</th> <th>b</th> <th>c</th> <th>d</th> <th>e</th> <th>f</th> <th>max. α</th> </tr> </thead> <tbody> <tr> <td>9</td> <td>40.3</td> <td>33.2</td> <td>15.6</td> <td>33.3</td> <td>1.5</td> <td>7.3</td> <td></td> </tr> <tr> <td>15</td> <td>53.4</td> <td>36.2</td> <td>15.6</td> <td>47</td> <td>2.7</td> <td>11.0</td> <td></td> </tr> <tr> <td>25</td> <td>70.2</td> <td>38.2</td> <td>15.3</td> <td>63.5</td> <td>2.7</td> <td>11.0</td> <td></td> </tr> <tr> <td>37</td> <td>88.1</td> <td>38.3</td> <td>18.3</td> <td>81.1</td> <td>2.7</td> <td>11.0</td> <td></td> </tr> </tbody> </table>		a	b	c	d	e	f	max. α	9	40.3	33.2	15.6	33.3	1.5	7.3		15	53.4	36.2	15.6	47	2.7	11.0		25	70.2	38.2	15.3	63.5	2.7	11.0		37	88.1	38.3	18.3	81.1	2.7	11.0	
					a	b	c	d	e	f	max. α																																	
9	40.3	33.2	15.6	33.3	1.5	7.3																																						
15	53.4	36.2	15.6	47	2.7	11.0																																						
25	70.2	38.2	15.3	63.5	2.7	11.0																																						
37	88.1	38.3	18.3	81.1	2.7	11.0																																						
Thermoplastic metallized																																												
		<p>09 67 009 0442 09 67 009 0443</p> <p>09 67 015 0442 09 67 015 0443</p> <p>09 67 025 0442 09 67 025 0443</p> <p>09 67 037 0442 09 67 037 0443</p> <p>09 67 050 0442 09 67 050 0443</p>																																										
* Available in yellow, red, green or blue on request																																												
Knurled Screw for hoods	9-50	black																																										
		tinned																																										
Thread UNC Thread M3		<p>09 67 000 9926²⁾ 09 67 000 9925²⁾</p> <p>09 67 000 9931²⁾ 09 67 000 9930²⁾</p>																																										
Male screw lock for use without hood	9-37 50	yellow chromatized																																										
		tinned																																										
Thread UNC/UNC Thread UNC/M3		<p>09 67 000 9927²⁾ 09 67 000 9928²⁾</p>																																										
Female screw lock with nut	9-50	yellow chromatized																																										
		tinned																																										
Thread UNC/UNC Thread UNC/M3		<p>09 67 000 9929²⁾ 09 67 000 9922²⁾</p> <p>09 67 000 9923²⁾ 09 67 000 9924²⁾</p>																																										
Female screw lock with nut	9-50	tinned																																										
		tinned																																										
Thread UNC/UNC		09 67 000 9973 ²⁾																																										
Female screw lock without nut	9-50	tinned																																										
		tinned																																										
Thread UNC/UNC Thread UNC/M3		<p>09 67 000 9972²⁾ 09 67 000 9974²⁾</p>																																										
U-Clip with thread 4-40 UNC	9-50	corrosion resistant steel																																										
		tinned																																										
		09 67 001 9928 ³⁾																																										

²⁾ Order 2 for each connector

³⁾ Part No. comprises 100 pieces

¹⁾ Use of knurled screws is possible. Please order separately.

D-Sub



Connector hoods for spring or slide locking

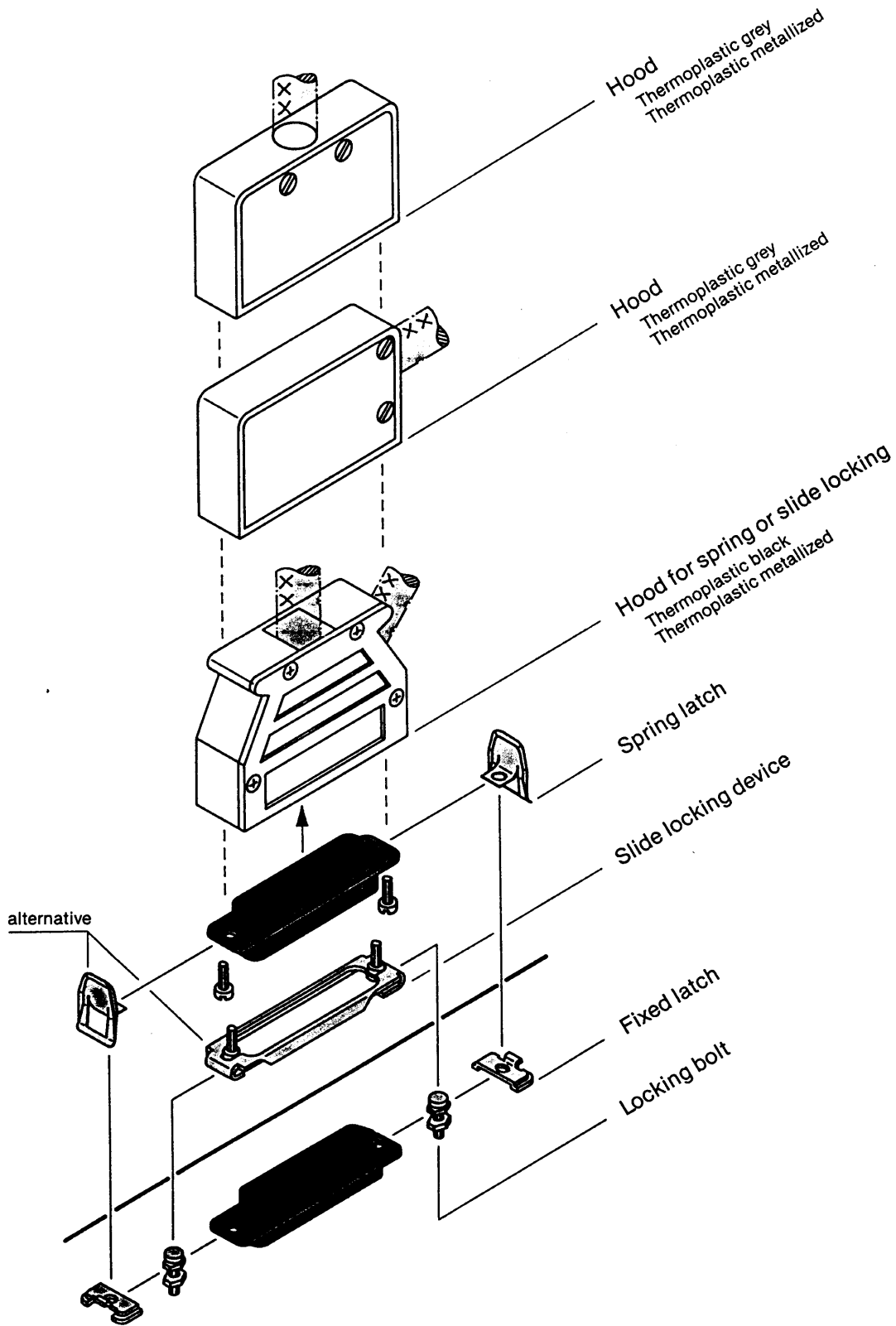

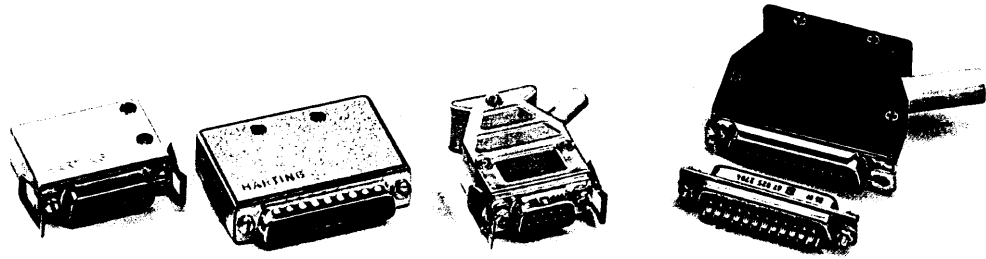

Hoods for spring or slide locking and accessories

Identification	No. of contacts	Part No.		Drawing	Dimensions in mm																																				
Hood top cable entry		Thermoplastic grey	Thermoplastic metallized		<table border="1"> <thead> <tr> <th>a</th> <th>b₁</th> <th>b₂</th> <th>c</th> <th>d</th> <th>min. e_{max}</th> </tr> </thead> <tbody> <tr> <td>9</td> <td>31</td> <td>23</td> <td>28</td> <td>12,8</td> <td>10 15,75 9</td> </tr> <tr> <td>15</td> <td>39,4</td> <td>28</td> <td>28</td> <td>12,8</td> <td>10 15,75 9</td> </tr> <tr> <td>25</td> <td>53,3</td> <td>34</td> <td>34</td> <td>12,8</td> <td>14 15,75 9</td> </tr> <tr> <td>37</td> <td>69,7</td> <td>43</td> <td>43</td> <td>12,8</td> <td>20 15,75 9</td> </tr> <tr> <td>50</td> <td>87,1</td> <td>41</td> <td>41</td> <td>15,6</td> <td>20 15,75 11,6</td> </tr> </tbody> </table>	a	b ₁	b ₂	c	d	min. e _{max}	9	31	23	28	12,8	10 15,75 9	15	39,4	28	28	12,8	10 15,75 9	25	53,3	34	34	12,8	14 15,75 9	37	69,7	43	43	12,8	20 15,75 9	50	87,1	41	41	15,6	20 15,75 11,6
	a	b ₁	b ₂			c	d	min. e _{max}																																	
	9	31	23			28	12,8	10 15,75 9																																	
	15	39,4	28			28	12,8	10 15,75 9																																	
	25	53,3	34			34	12,8	14 15,75 9																																	
37	69,7	43	43	12,8	20 15,75 9																																				
50	87,1	41	41	15,6	20 15,75 11,6																																				
	9	09 67 009 0411	09 67 009 0413																																						
	15	09 67 015 0411	09 67 015 0413																																						
	25	09 67 025 0411	09 67 025 0413																																						
	37	09 67 037 0411	09 67 037 0413																																						
9-37 way for packaging density of 3 TE (15.24 mm)	50	09 67 050 0411	09 67 050 0413																																						
Hood side cable entry		Thermoplastic grey	Thermoplastic metallized																																						
		9	09 67 009 0511			09 67 009 0513																																			
		15	09 67 015 0511			09 67 015 0513																																			
		25	09 67 025 0511			09 67 025 0513																																			
		37	09 67 037 0511			09 67 037 0513																																			
9-37 way for packaging density of 3 TE (15.24 mm)	50	09 67 050 0511	09 67 050 0513																																						
Hood for spring or slide locking		Thermoplastic black	Thermoplastic metallized		<table border="1"> <thead> <tr> <th>a</th> <th>c</th> <th>d</th> <th>min. e_{max}</th> </tr> </thead> <tbody> <tr> <td>9</td> <td>31</td> <td>15,4</td> <td>7 1,7 7,8</td> </tr> <tr> <td>15</td> <td>39,4</td> <td>15,4</td> <td>7 1,7 8</td> </tr> <tr> <td>25</td> <td>53,2</td> <td>15,4</td> <td>9 1,5 8</td> </tr> <tr> <td>37</td> <td>69,5</td> <td>15,4</td> <td>9 1,5 8</td> </tr> <tr> <td>50</td> <td>87</td> <td>17,9</td> <td>9 1,5 8</td> </tr> </tbody> </table>	a	c	d	min. e _{max}	9	31	15,4	7 1,7 7,8	15	39,4	15,4	7 1,7 8	25	53,2	15,4	9 1,5 8	37	69,5	15,4	9 1,5 8	50	87	17,9	9 1,5 8												
	a	c	d			min. e _{max}																																			
	9	31	15,4			7 1,7 7,8																																			
	15	39,4	15,4			7 1,7 8																																			
	25	53,2	15,4			9 1,5 8																																			
37	69,5	15,4	9 1,5 8																																						
50	87	17,9	9 1,5 8																																						
	9	09 67 009 0452	09 67 009 0453																																						
	15	09 67 015 0452	09 67 015 0453																																						
	25	09 67 025 0452	09 67 025 0453																																						
	37	09 67 037 0452	09 67 037 0453																																						
	50	09 67 050 0452	09 67 050 0453																																						
Spring latch	9-50	corrosion resistant steel																																							
		09 67 000 9907 ¹⁾																																							
Fixed latch	9-37-50	yellow chromatzed																																							
		09 67 000 9908 ¹⁾																																							
		09 67 000 9909 ¹⁾																																							
Slide locking device	9-50	corrosion resistant steel																																							
	9	09 67 000 9914																																							
	15	09 67 000 9915																																							
	25	09 67 000 9916																																							
	37	09 67 000 9917																																							
	50	09 67 000 9918																																							
Locking bolt	9-50	yellow chromatzed																																							
		09 67 000 9919 ¹⁾																																							

¹⁾ Order 2 for each connector

Robust and reliable connections

The progressive development of computer controlled machines and the standardisation of electrical interfaces necessitates an increased use of sweep radiation-proof "D" Subminiature connectors. This requirement is met by the use of robust hoods and housings from the Heavy Duty Han range which also provide a high degree of protection against the ingress of moisture and dust.

HARTING is now supplying metal adaptor blocks by means of which 25 way D-Sub connectors can be mounted into Han 10 A and 37 way D-Sub connectors into Han 16 A hoods and housings (catalogue Heavy Duty Connectors). D-Sub connectors with solder buckets, crimp or insulation displacement termination can be used in Han A hoods and housings.

Sequence of assembly

1. Fix the adaptor blocks with +/- multiple purpose screws in the Han A housing.
2. Mount the D-Sub connectors with the cheese-head screws into the recesses of the adaptor blocks.

Degree of protection IP 65 according to DIN 40050 for Han A hoods and housings

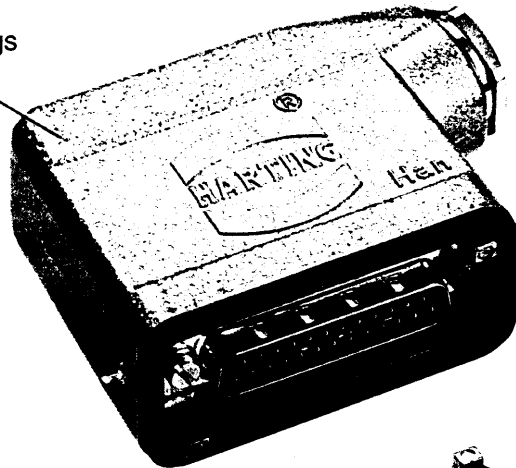

When locking the connectors the guide cams absorb the arising force component (90° to the mating direction).

Conductive connection between metal collar and housing

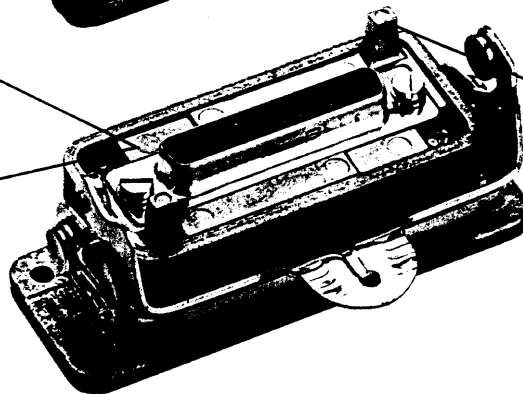

The contacts are protected from mechanical overloading.

Secure screening of the connectors

The part number of the 25 and 37 way adaptor contains:

- 2 adaptor blocks
- 2 +/- multiple purpose screws M3
- 2 cheese head screws M3
- 2 spring washers

Part No.
09 20 000 9925

List of part numbers



Part No.	Page	Part No.	Page	Part No.	Page	Part No.	Page	Part No.	Page
09 66 421 6703	9	09 66 511 6503	9	09 66 561 7702	9	09 67 000 9917	28	09 67 009 4701	16
09 66 421 7701	9	09 66 511 7501	9	09 66 561 7703	9	09 67 000 9918	28	09 67 009 4704	7
09 66 421 7702	9	09 66 511 7502	9			09 67 000 9919	28	09 67 009 4707	19
09 66 421 7703	9	09 66 511 7503	9	09 66 562 6811	10	09 67 000 9922	26	09 67 009 4715	7
				09 66 562 6812	10	09 67 000 9923	26	09 67 009 4716	19
09 66 422 6801	11	09 66 512 6601	11	09 66 562 6813	10	09 67 000 9924	26	09 67 009 4754	8
09 66 422 6802	11	09 66 512 6602	11	09 66 562 7811	10	09 67 000 9925	26	09 67 009 4755	8
09 66 422 6803	11	09 66 512 6603	11	09 66 562 7812	10	09 67 000 9926	26	09 67 009 4757	14
09 66 422 7801	11	09 66 512 7601	11	09 66 562 7813	10	09 67 000 9927	26	09 67 009 4758	14
09 66 422 7802	11	09 66 512 7602	11			09 67 000 9928	26	09 67 009 4763	14
09 66 422 7803	11	09 66 512 7603	11	09 66 563 6811	10	09 67 000 9929	26	09 67 009 4764	14
				09 66 563 6812	10	09 67 000 9930	26	09 67 009 5601	16
09 66 423 6801	11	09 66 513 6601	11	09 66 563 6813	10	09 67 000 9931	26	09 67 009 5604	7
09 66 423 6802	11	09 66 513 6602	11	09 66 563 7811	10	09 67 000 9935	15	09 67 009 5607	19
09 66 423 6803	11	09 66 513 6603	11	09 66 563 7812	10	09 67 000 9938	15	09 67 009 5615	7
09 66 423 7801	11	09 66 513 7601	11	09 66 563 7813	10	09 67 000 9939	15	09 67 009 5616	19
09 66 423 7802	11	09 66 513 7602	11			09 67 000 9971	23	09 67 009 5654	8
09 66 423 7803	11	09 66 513 7603	11	09 67 000 7137	17	09 67 000 9972	26	09 67 009 5655	8
				09 67 000 7138	17	09 67 000 9973	26	09 67 009 5657	14
09 66 428 6700	20	09 66 521 6701	9	09 67 000 7147	17	09 67 000 9974	26	09 67 009 5658	14
09 66 428 7700	20	09 66 521 6702	9	09 67 000 7148	17	09 67 000 9987	15	09 67 009 5663	14
		09 66 521 6703	9	09 67 000 7157	17	09 67 000 9988	15	09 67 009 5664	14
09 66 451 6501	9	09 66 521 7701	9	09 67 000 7158	17	09 67 000 9989	15		
09 66 451 6502	9	09 66 521 7702	9	09 67 000 7167	17	09 67 000 9990	15	09 67 015 0411	28
09 66 451 6503	9	09 66 521 7703	9	09 67 000 7168	17	09 67 000 9991	15	09 67 015 0413	28
09 66 451 7501	9			09 67 000 7177	17	09 67 000 9997	15	09 67 015 0421	24
09 66 451 7502	9	09 66 522 6801	11	09 67 000 7178	17	09 67 000 9998	15	09 67 015 0422	24
09 66 451 7503	9	09 66 522 6802	11	09 67 000 7237	17			09 67 015 0424	24
		09 66 522 6803	11	09 67 000 7238	17	09 67 001 9928	26	09 67 015 0425	24
09 66 452 6611	10	09 66 522 7801	11	09 67 000 7247	17			09 67 015 0442	26
09 66 452 6612	10	09 66 522 7802	11	09 67 000 7248	17	09 67 009 0411	28	09 67 015 0443	26
09 66 452 6613	10	09 66 522 7803	11	09 67 000 7257	17	09 67 009 0413	28	09 67 015 0452	28
09 66 452 7611	10			09 67 000 7258	17	09 67 009 0421	24	09 67 015 0453	28
09 66 452 7612	10	09 66 523 6801	11	09 67 000 7267	17	09 67 009 0422	24	09 67 015 0511	28
09 66 452 7613	10	09 66 523 6802	11	09 67 000 7268	17	09 67 009 0424	24	09 67 015 0513	28
		09 66 523 6803	11	09 67 000 7277	17	09 67 009 0425	24	09 67 015 0571	23
09 66 453 6611	10	09 66 523 6803	11	09 67 000 7278	17	09 67 009 0442	26	09 67 015 0573	23
09 66 453 6612	10	09 66 523 7801	11	09 67 000 8137	17	09 67 009 0443	26	09 67 015 2604	7
09 66 453 6613	10	09 66 523 7802	11	09 67 000 8138	17	09 67 009 0452	28	09 67 015 2607	19
09 66 453 7611	10	09 66 523 7803	11	09 67 000 8147	17	09 67 009 0453	28	09 67 015 2615	7
09 66 453 7612	10			09 67 000 8148	17	09 67 009 0511	28	09 67 015 2616	19
09 66 453 7613	10	09 66 551 6501	9	09 67 000 8157	17	09 67 009 0513	28	09 67 015 2654	8
		09 66 551 6502	9	09 67 000 8158	17	09 67 009 0571	23	09 67 015 2655	8
09 66 461 6701	9	09 66 551 6503	9	09 67 000 8167	17	09 67 009 0573	23	09 67 015 2657	14
09 66 461 6702	9	09 66 551 7501	9	09 67 000 8168	17	09 67 009 2604	7	09 67 015 2658	14
09 66 461 6703	9	09 66 551 7502	9	09 67 000 8177	17	09 67 009 2607	19	09 67 015 2663	14
09 66 461 7701	9	09 66 551 7503	9	09 67 000 8178	17	09 67 009 2615	7	09 67 015 2664	14
09 66 461 7702	9			09 67 000 8237	17	09 67 009 2616	19	09 67 015 2704	7
09 66 461 7703	9	09 66 552 6611	10	09 67 000 8238	17	09 67 009 2654	8	09 67 015 2707	19
		09 66 552 6612	10	09 67 000 8247	17	09 67 009 2655	8	09 67 015 2715	7
09 66 462 6811	10	09 66 552 6613	10	09 67 000 8248	17	09 67 009 2657	14	09 67 015 2716	19
09 66 462 6812	10	09 66 552 7611	10	09 67 000 8257	17	09 67 009 2658	14	09 67 015 2754	8
09 66 462 6813	10	09 66 552 7612	10	09 67 000 8258	17	09 67 009 2663	14	09 67 015 2755	8
09 66 462 7811	10	09 66 552 7613	10	09 67 000 8267	17	09 67 009 2664	14	09 67 015 2757	14
09 66 462 7812	10			09 67 000 8268	17	09 67 009 2704	7	09 67 015 2758	14
09 66 462 7813	10	09 66 553 6611	10	09 67 000 8277	17	09 67 009 2707	19	09 67 015 2763	14
		09 66 553 6612	10	09 67 000 8278	17	09 67 009 2715	7	09 67 015 2764	14
09 66 463 6811	10	09 66 553 6613	10	09 67 000 9907	28	09 67 009 2716	19	09 67 015 3001	16
09 66 463 6812	10	09 66 553 7611	10	09 67 000 9908	28	09 67 009 2754	8	09 67 015 3101	16
09 66 463 6813	10	09 66 553 7612	10	09 67 000 9909	28	09 67 009 2755	8	09 67 015 4701	16
09 66 463 7811	10	09 66 553 7613	10	09 67 000 9910	15	09 67 009 2757	14	09 67 015 4704	7
09 66 463 7812	10			09 67 000 9911	15	09 67 009 2758	14	09 67 015 4707	19
09 66 463 7813	10	09 66 561 6701	9	09 67 000 9913	15	09 67 009 2763	14	09 67 015 4715	7
		09 66 561 6702	9	09 67 000 9914	28	09 67 009 2764	14	09 67 015 4716	19
09 66 511 6501	9	09 66 561 6703	9	09 67 000 9915	28	09 67 009 3001	16	09 67 015 4754	8
09 66 511 6502	9	09 66 561 7701	9	09 67 000 9916	28	09 67 009 3101	16	09 67 015 4755	8

List of part numbers



Part No.	Page	Part No.	Page	Part No.	Page	Part No.	Page	Part No.	Page
09 67 015 4757	14	09 67 025 5615	7	09 67 037 5664	14	09 67 215 2604	7	09 98 000 2000	18
09 67 015 4758	14	09 67 025 5616	19	09 67 050 0411	28	09 67 215 2615	7	09 98 000 2008	18
09 67 015 4763	14	09 67 025 5654	8			09 67 215 2704	7	09 98 000 2009	18
09 67 015 4764	14	09 67 025 5655	8	09 67 050 0413	28	09 67 215 2715	7		
09 67 015 5601	16	09 67 025 5657	14	09 67 050 0424	24	09 67 215 4704	7	09 99 000 0097	15
09 67 015 5604	7	09 67 025 5658	14	09 67 050 0442	26	09 67 215 4715	7	09 99 000 0114	21
09 67 015 5607	19	09 67 025 5663	14	09 67 050 0443	26	09 67 215 5604	7	09 99 000 0114	23
09 67 015 5615	7	09 67 025 5664	14	09 67 050 0452	28	09 67 215 5615	7	09 99 000 0116	21
09 67 015 5616	19			09 67 050 0453	28			09 99 000 0135	21
09 67 015 5654	8	09 67 037 0411	28	09 67 050 0511	28	09 67 225 2604	7	09 99 000 0149	21
09 67 015 5655	8	09 67 037 0413	28	09 67 050 0513	28	09 67 225 2615	7	09 99 000 0158	18
09 67 015 5657	14	09 67 037 0421	24	09 67 050 0571	23	09 67 225 2704	7	09 99 000 0169	18
09 67 015 5658	14	09 67 037 0422	24	09 67 050 0573	23	09 67 225 2715	7	09 99 000 0171	18
09 67 015 5663	14	09 67 037 0424	24	09 67 050 2604	7	09 67 225 4704	7	09 99 000 0175	18
09 67 015 5664	14	09 67 037 0425	24	09 67 050 2607	19	09 67 225 4715	7	09 99 000 0179	21
		09 67 037 0442	26	09 67 050 2615	7	09 67 225 5604	7	09 99 000 0180	21
09 67 025 0411	28	09 67 037 0443	26	09 67 050 2616	19	09 67 225 5615	7	09 99 000 0215	23
09 67 025 0413	28	09 67 037 0452	28	09 67 050 2654	8			09 99 000 0216	23
09 67 025 0421	24	09 67 037 0453	28	09 67 050 2655	8	09 67 237 2604	7	09 99 000 0233	25
09 67 025 0422	24	09 67 037 0511	28	09 67 050 2657	14	09 67 237 2615	7	09 99 000 0235	25
09 67 025 0424	24	09 67 037 0513	28	09 67 050 2658	14	09 67 237 2704	7	09 99 000 0236	25
09 67 025 0425	24	09 67 037 0571	23	09 67 050 2663	14	09 67 237 2715	7	09 99 000 0237	25
09 67 025 0442	26	09 67 037 0573	23	09 67 050 2664	14	09 67 237 4704	7	09 99 000 0246	18
09 67 025 0443	26	09 67 037 2604	7	09 67 050 2704	7	09 67 237 4715	7	09 99 000 0253	182
09 67 025 0452	28	09 67 037 2607	19	09 67 050 2707	19	09 67 237 5604	7		
09 67 025 0453	28	09 67 037 2615	7	09 67 050 2715	7	09 67 237 5615	7		
09 67 025 0511	28	09 67 037 2616	19	09 67 050 2716	19				
09 67 025 0513	28	09 67 037 2654	8	09 67 050 2754	8	09 68 153 5612	12		
09 67 025 0571	23	09 67 037 2655	8	09 67 050 2755	8	09 68 153 5613	12		
09 67 025 0573	23	09 67 037 2657	14	09 67 050 2757	14	09 68 153 7612	12		
09 67 025 2604	7	09 67 037 2658	14	09 67 050 2758	14	09 68 153 7613	12		
09 67 025 2607	19	09 67 037 2663	14	09 67 050 2763	14				
09 67 025 2615	7	09 67 037 2664	14	09 67 050 2764	14	09 68 163 5812	12		
09 67 025 2616	19	09 67 037 2704	7	09 67 050 3001	16	09 68 163 5813	12		
09 67 025 2654	8	09 67 037 2707	19	09 67 050 3101	16	09 68 163 7812	12		
09 67 025 2655	8	09 67 037 2715	7	09 67 050 4701	16	09 68 163 7813	12		
09 67 025 2657	14	09 67 037 2716	19	09 67 050 4704	7				
09 67 025 2658	14	09 67 037 2754	8	09 67 050 4707	19	09 68 253 5612	12		
09 67 025 2663	14	09 67 037 2755	8	09 67 050 4715	7	09 68 253 5613	12		
09 67 025 2664	14	09 67 037 2757	14	09 67 050 4716	19	09 68 253 7612	12		
09 67 025 2704	7	09 67 037 2758	14	09 67 050 4754	8	09 68 253 7613	12		
09 67 025 2707	19	09 67 037 2763	14	09 67 050 4755	8				
09 67 025 2715	7	09 67 037 2764	14	09 67 050 4757	14	09 68 263 5812	12		
09 67 025 2716	19	09 67 037 3001	16	09 67 050 4758	14	09 68 263 5813	12		
09 67 025 2754	8	09 67 037 3101	16	09 67 050 4763	14	09 68 263 7812	12		
09 67 025 2755	8	09 67 037 4701	16	09 67 050 4764	14	09 68 263 7813	12		
09 67 025 2757	14	09 67 037 4704	7	09 67 050 5601	16				
09 67 025 2758	14	09 67 037 4707	19	09 67 050 5604	7	09 68 353 5612	12		
09 67 025 2763	14	09 67 037 4715	7	09 67 050 5607	19	09 68 353 5613	12		
09 67 025 2764	14	09 67 037 4716	19	09 67 050 5615	7	09 68 353 7612	12		
09 67 025 3001	16	09 67 037 4754	8	09 67 050 5616	19	09 68 353 7613	12		
09 67 025 3101	16	09 67 037 4755	8	09 67 050 5654	8				
09 67 025 4701	16	09 67 037 4757	14	09 67 050 5655	8	09 68 363 5812	12		
09 67 025 4704	7	09 67 037 4758	14	09 67 050 5657	14	09 68 363 5813	12		
09 67 025 4707	19	09 67 037 4763	14	09 67 050 5658	14	09 68 363 7812	12		
09 67 025 4715	7	09 67 037 4764	14	09 67 050 5663	14	09 68 363 7813	12		
09 67 025 4716	19	09 67 037 5601	16	09 67 050 5664	14				
09 67 025 4754	8	09 67 037 5604	7			09 68 453 5612	12		
09 67 025 4755	8	09 67 037 5607	19	09 67 209 2604	7	09 68 453 5613	12		
09 67 025 4757	14	09 67 037 5615	7	09 67 209 2615	7	09 68 453 7612	12		
09 67 025 4758	14	09 67 037 5616	19	09 67 209 2704	7	09 68 453 7613	12		
09 67 025 4763	14	09 67 037 5654	8	09 67 209 2715	7				
09 67 025 4764	14	09 67 037 5655	8	09 67 209 4704	7	09 68 463 5812	12		
09 67 025 5601	16	09 67 037 5657	14	09 67 209 4715	7	09 68 463 5813	12		
09 67 025 5604	7	09 67 037 5658	14	09 67 209 5604	7	09 68 463 7812	12		
09 67 025 5607	19	09 67 037 5663	14	09 67 209 5615	7	09 68 463 7813	12		