

1. Marking method

Laser Marking

2. Marking

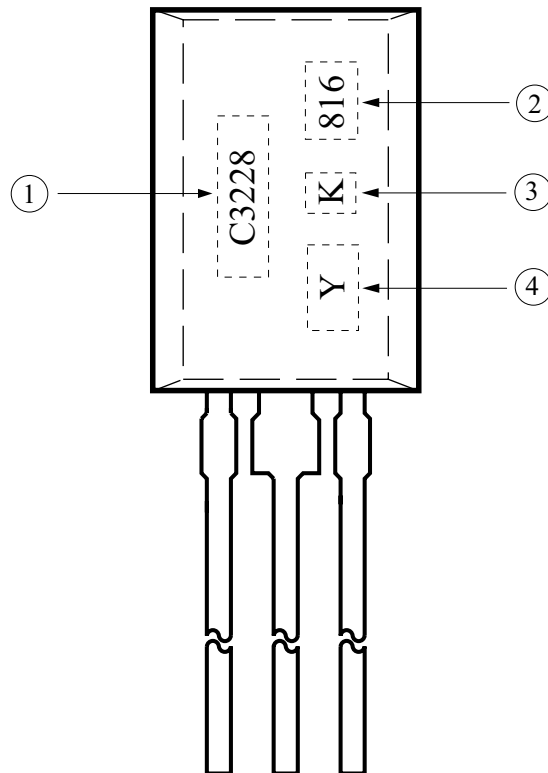

No.	Item	Marking	Description		
①	KEC	K	KEC CORPORATION		
②	Lot No.	816	8	Year	0~9 : 2000~2009
			16	Week	16 : 16th Week
③	Device Name	C3228	KTC3228		
④	hFE Grade	Y	O, Y, R		