

PWM Off-Line Switching Regulator ICs

Features and Benefits

- Current mode PWM control
- Built-in Random Switching function: reduces EMI noise, simplifies EMI filters, and cuts cost by external part reduction
- Built-in Slope Compensation function: avoids subharmonic oscillation
- Built-in Leading Edge Blanking (LEB) function
- Auto Standby function:
 - Input power, $P_{IN} < 10 \text{ mW}$ at no load with low power consumption shunt regulator
 - Normal load operation: PWM switching
 - Light load operation: Standby mode (Burst oscillation)

Continued on the next page...

Package: DIP8



Not to scale

Description

STR3A100 series are power ICs for switching power supplies, incorporating a power MOSFET and a current mode PWM controller IC in one package.

Including a startup circuit and a standby function in the controller, the product achieves low power consumption, low standby power, and high cost-effectiveness in power supply systems, while reducing external components.

The products are provided in an industry standard DIP8 package.

Applications

Switching power supplies for electronic devices such as:

- Stand-by power supply for LCD/PDP television, desktop PC, multi-function printer, audio equipment, and so forth
- Small switched-mode power supply (SMPS) for printer, BD/DVD player, set-top box, and so forth
- Auxiliary power supply for air conditioner, refrigerator, washer, dishwasher, and so forth

Typical Application

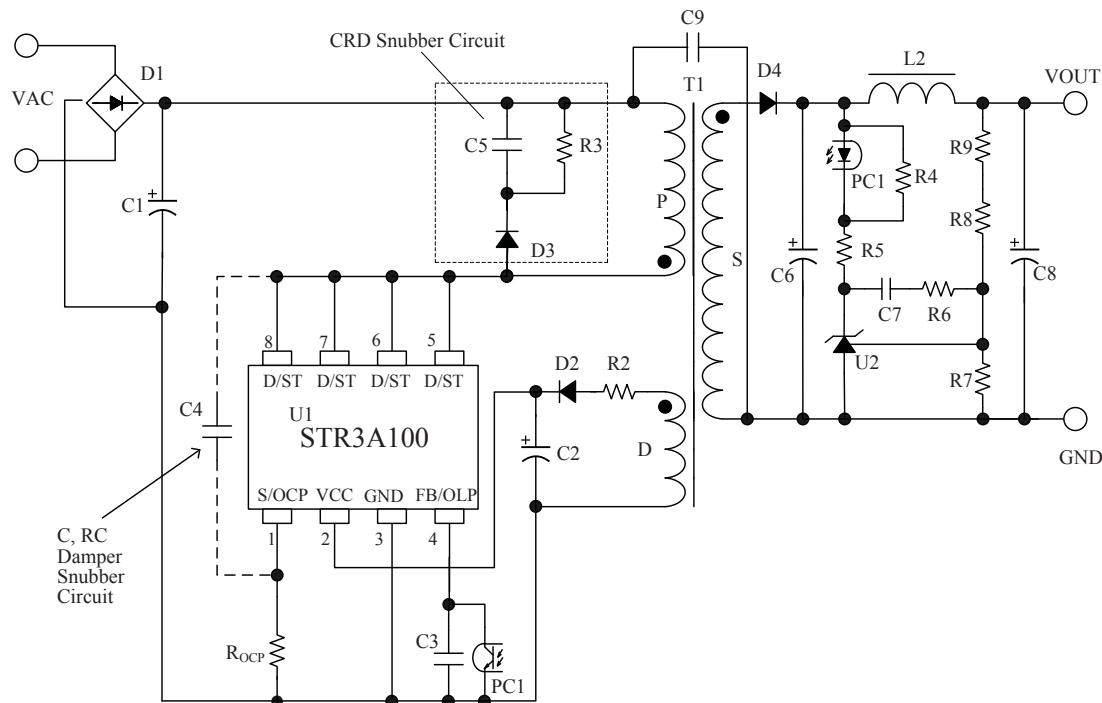

Features and Benefits (continued)

- Soft Start function: reduces stress on internal power MOSFET and secondary output rectifier diode at startup
- Protection Functions:
 - Overcurrent Protection function (OCP); pulse-by-pulse, built-in compensation circuit to minimize OCP point variation on AC input voltage
 - Overload Protection function (OLP); auto restart, built-in timer, reduces heat during overload condition, and no external components required
 - Overvoltage Protection function (OVP); auto restart
 - Thermal Shutdown function (TSD); auto restart

Selection Guide

| Part Number | f _{osc} (kHz) | MOSFET | | P _{OUT} * (W) | | OVP/TSD |
|-------------|---------------------------|------------------------------|---------------------------------|---------------------------|---------------|--------------|
| | | V _{DSS(min)} (V) | R _{DS(on)(max)} (Ω) | 230 VAC | 85 to 265 VAC | |
| STR3A151D | 67 | 650 | 4.0 | 24 | 16 | Auto restart |
| STR3A152D | | | 3.0 | 30 | 23 | |
| STR3A153D | | | 1.9 | 36 | 30 | |
| STR3A154D | | | 1.4 | 40 | 32 | |
| STR3A155D | | | 1.1 | 43 | 35 | |

*The listed output power is based on the thermal ratings, and the peak output power can be 120% to 140% of the value stated here. At low output voltage and short duty cycle, the output power may be less than the value stated here.

The polarity value for current specifies a sink as "+," and a source as "-", referencing the IC.

Absolute Maximum Ratings Unless specifically noted, T_A is 25°C

| Characteristic | Symbol | Notes | Pins | Rating | Unit | | |
|---------------------------------------|-------------|--------------------------------|--|------------|------------------------------------|------------------------|-----|
| Drain Peak Current ¹ | I_{DPEAK} | STR3A151D | Single pulse | 8-1 | 3.6 | A | |
| | | STR3A152D | | | 4 | A | |
| | | STR3A153D | | | 5.2 | A | |
| | | STR3A154D | | | 6.4 | A | |
| | | STR3A155D | | | 7.2 | A | |
| Avalanche Energy ² | E_{AS} | STR3A151D | Single pulse, $I_{LPEAK} = 2.13$ A | 8-1 | 53 | mJ | |
| | | STR3A152D | | | Single pulse, $I_{LPEAK} = 2.19$ A | 56 | mJ |
| | | STR3A153D | | | Single pulse, $I_{LPEAK} = 2.46$ A | 72 | mJ |
| | | STR3A154D | | | Single pulse, $I_{LPEAK} = 2.66$ A | 83 | mJ |
| | | STR3A155D | | | Single pulse, $I_{LPEAK} = 3.05$ A | 110 | mJ |
| S/OCP Pin Voltage | V_{OCP} | | 1-3 | -2 to 6 | V | | |
| Control Part Input Voltage | V_{CC} | | 2-3 | 32 | V | | |
| FB/OLP Pin Voltage | V_{FB} | | 4-3 | -0.3 to 14 | V | | |
| FB/OLP Pin Sink Current | I_{FB} | | 4-3 | 1.0 | mA | | |
| MOSFET Power Dissipation ³ | P_{D1} | STR3A151D STR3A152D | Mounted on 15 mm × 15 mm printed circuit board | 8-1 | 1.68 | W | |
| | | STR3A153D STR3A154D | | | 1.76 | W | |
| | | STR3A155D | | | 1.81 | W | |
| | | Control Part Power Dissipation | | | P_{D2} | $V_{CC} \times I_{CC}$ | 2-3 |
| Operating Ambient Temperature | T_{OP} | | - | -40 to 125 | °C | | |
| Storage Temperature | T_{stg} | | - | -40 to 125 | °C | | |
| Channel Temperature | T_{ch} | | - | 150 | °C | | |

¹Refer to MOSFET Safe Operating Area Curve.

²Refer to MOSFET Avalanche Energy Derating Coefficient Curve.

³Refer to MOSFET Temperature versus Power Dissipation Curve.

Electrical Characteristics of Control Part Unless specifically noted, T_A is 25°C, $V_{CC} = 18\text{ V}$

| Characteristic | Symbol | Test Conditions | Pins | Min. | Typ. | Max. | Unit | |
|--|-----------------|-------------------------------------|------------------------|-------|------|------|-------|---|
| Operation Start Voltage | $V_{CC(ON)}$ | | 2 – 3 | 13.8 | 15.3 | 16.8 | V | |
| Operation Stop Voltage* | $V_{CC(OFF)}$ | | 2 – 3 | 7.3 | 8.1 | 8.9 | V | |
| Circuit Current in Operation | $I_{CC(ON)}$ | $V_{CC} = 12\text{ V}$ | 2 – 3 | – | – | 2.5 | mA | |
| Minimum Start Voltage | $V_{ST(ON)}$ | | 8 – 3 | – | 40 | – | V | |
| Startup Current | $I_{STARTUP}$ | $V_{CC} = 13.5\text{ V}$ | 2 – 3 | –3.9 | –2.5 | –1.1 | mA | |
| Startup Current Threshold Biasing Voltage* | $V_{CC(BIAS)}$ | | 2 – 3 | 8.5 | 9.5 | 10.5 | V | |
| Average Operation Frequency | $f_{OSC(AVG)}$ | | 8 – 3 | 60 | 67 | 74 | kHz | |
| Frequency Modulation Deviation | Δf | | 8 – 3 | – | 5 | – | kHz | |
| Maximum Duty Cycle | D_{MAX} | | 8 – 3 | 65 | 74 | 83 | % | |
| Leading Edge Blanking Time | t_{BW} | | – | – | 350 | – | ns | |
| OCP Compensation Coefficient | DPC | | – | – | 17 | – | mV/μs | |
| OCP Compensation Duty Cycle Limit | D_{DPC} | | – | – | 36 | – | % | |
| OCP Threshold Voltage at Zero Duty Cycle | $V_{OCP(L)}$ | | 1 – 3 | 0.69 | 0.78 | 0.87 | V | |
| OCP Threshold Voltage at 36% Duty Cycle | $V_{OCP(H)}$ | | 1 – 3 | 0.79 | 0.88 | 0.97 | V | |
| Maximum Feedback Current | $I_{FB(MAX)}$ | | 4 – 3 | –110 | –70 | –35 | μA | |
| Minimum Feedback Current | $I_{FB(MIN)}$ | | 4 – 3 | –30 | –15 | –7 | μA | |
| FB/OLP Oscillation Stop Threshold Voltage | $V_{FB(OFF)}$ | STR3A151D STR3A152D STR3A153D | $V_{CC} = 32\text{ V}$ | 4 – 3 | 1.09 | 1.21 | 1.33 | V |
| | | STR3A154D STR3A155D | $V_{CC} = 32\text{ V}$ | 4 – 3 | 0.85 | 0.98 | 1.09 | V |
| OLP Threshold Voltage | $V_{FB(OLP)}$ | $V_{CC} = 32\text{ V}$ | 4 – 3 | 7.3 | 8.1 | 8.9 | V | |
| OLP Operation Current | $I_{CC(OLP)}$ | $V_{CC} = 12\text{ V}$ | 2 – 3 | – | 230 | – | μA | |
| OLP Delay Time | t_{OLP} | | – | 54 | 70 | 86 | ms | |
| FB/OLP Clamp Voltage | $V_{FB(CLAMP)}$ | | 4 – 3 | 11.0 | 12.8 | 14.0 | V | |
| OVP Threshold Voltage | $V_{CC(OVP)}$ | | 2 – 3 | 27.5 | 29.5 | 31.5 | V | |
| Thermal Shutdown Activating Temperature | $T_{J(TSD)}$ | | – | 135 | – | – | °C | |

* $V_{CC(BIAS)} > V_{CC(OFF)}$ always.

Electrical Characteristics of MOSFET Unless specifically noted, T_A is 25°C

| Characteristic | Symbol | Test Conditions | Pins | Min. | Typ. | Max. | Unit | |
|-----------------------------------|-------------------|-------------------------------------|-------|------|------|------|----------|----------------|
| Drain-to-Source Breakdown Voltage | V_{DSS} | | 8 – 1 | 650 | – | – | V | |
| Drain Leakage Current | I_{DSS} | | 8 – 1 | – | – | 300 | μ A | |
| On-Resistance | $R_{DS(ON)}$ | STR3A151D | 8 – 1 | – | – | 4.0 | Ω | |
| | | STR3A152D | | – | – | 3.0 | Ω | |
| | | STR3A153D | | – | – | 1.9 | Ω | |
| | | STR3A154D | | – | – | 1.4 | Ω | |
| | | STR3A155D | | – | – | 1.1 | Ω | |
| Switching Time | t_f | | 8 – 1 | – | – | 250 | ns | |
| Thermal Resistance | $R_{\theta ch-C}$ | STR3A151D STR3A152D STR3A153D | | – | – | – | 18 | $^{\circ}$ C/W |
| | | STR3A154D STR3A155D | | | | | – | – |

Characteristic Performance
STR3A151D

S. O. A. Temperature Derating Coefficient Curve

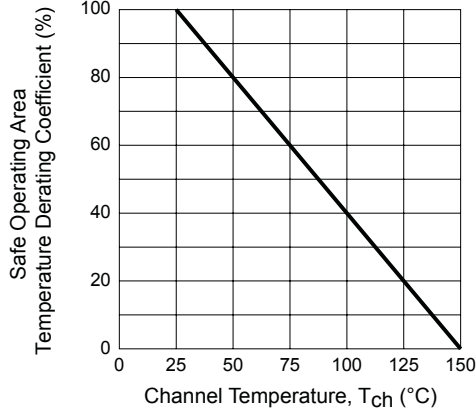

MOSFET Safe Operating Area Curve

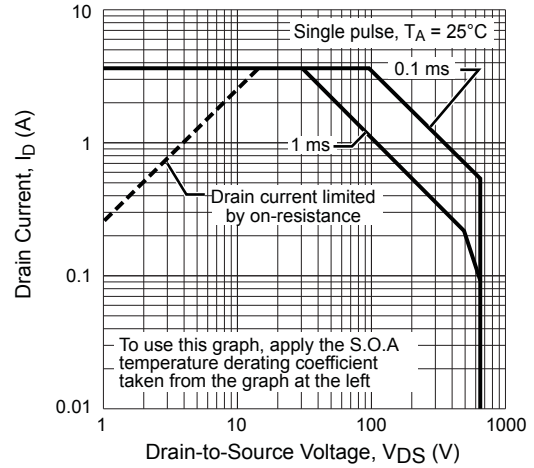

MOSFET Avalanche Energy Derating Coefficient Curve

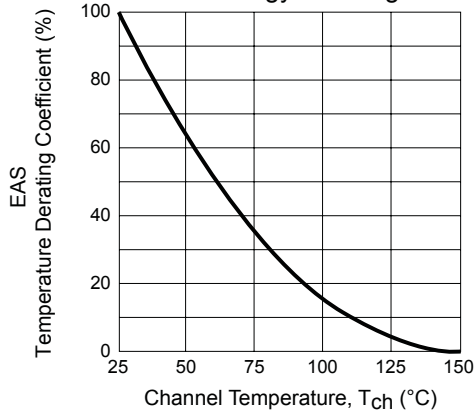

MOSFET Temperature versus Power Dissipation Curve

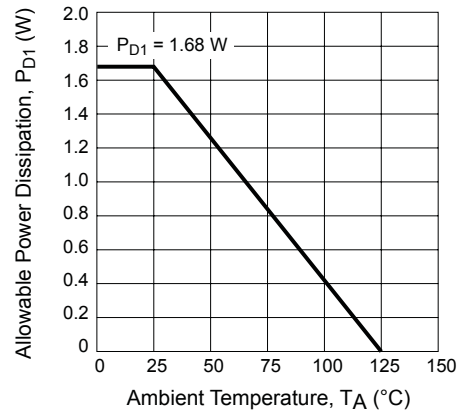

Transient Thermal Resistance Curve

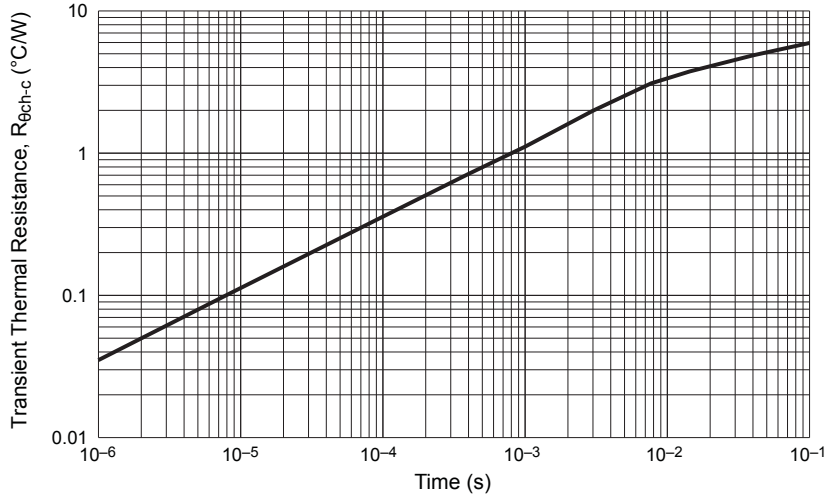

Characteristic Performance
STR3A152D

S. O. A. Temperature Derating Coefficient Curve

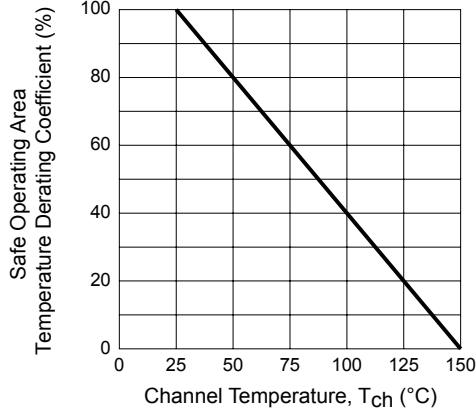

MOSFET Safe Operating Area Curve

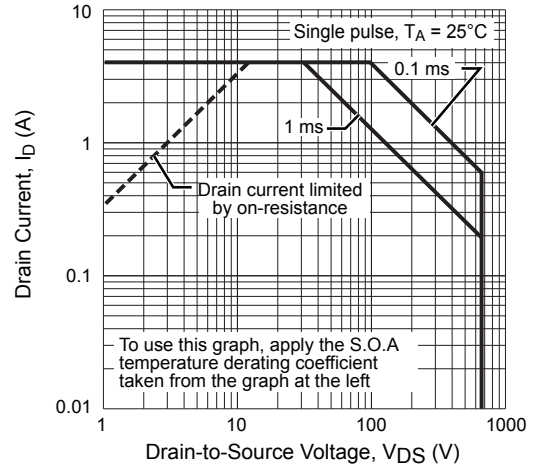

MOSFET Avalanche Energy Derating Coefficient Curve

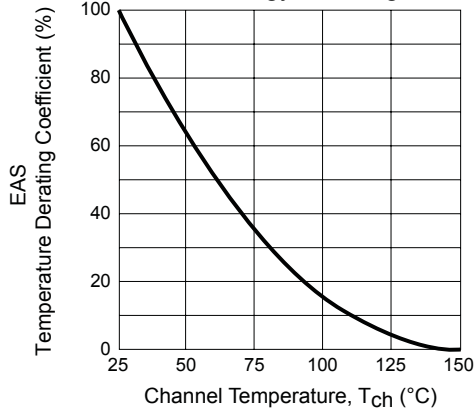

MOSFET Temperature versus Power Dissipation Curve

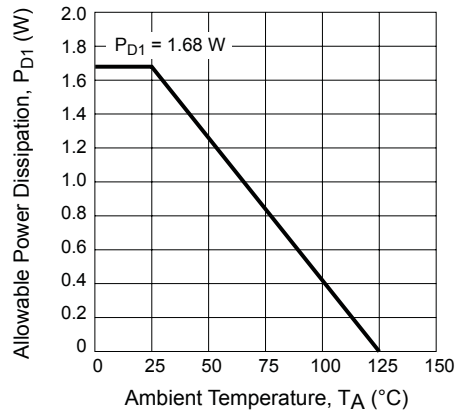

Transient Thermal Resistance Curve

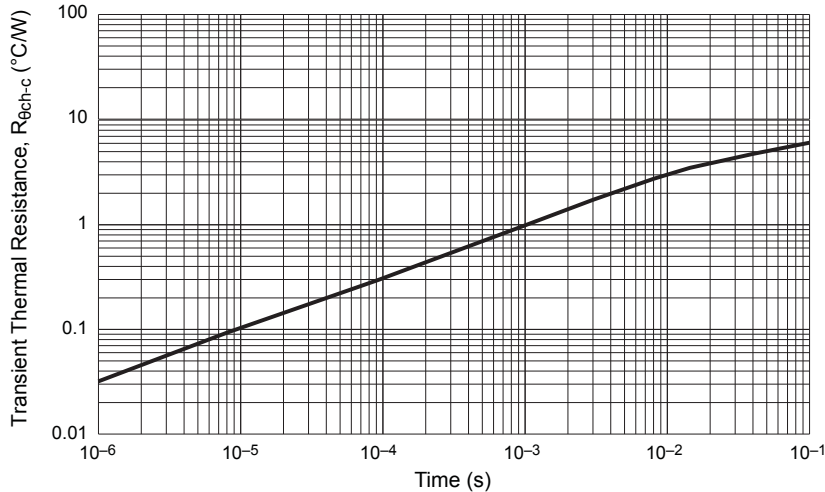

Characteristic Performance
STR3A153D

S. O. A. Temperature Derating Coefficient Curve

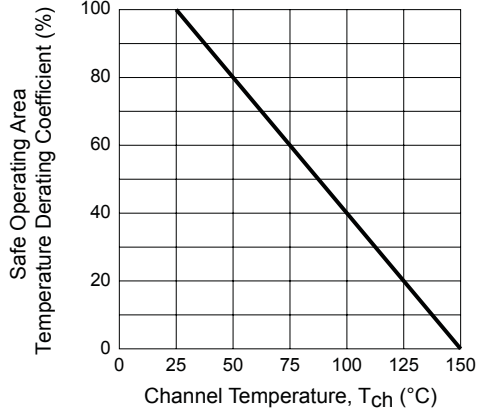

MOSFET Safe Operating Area Curve

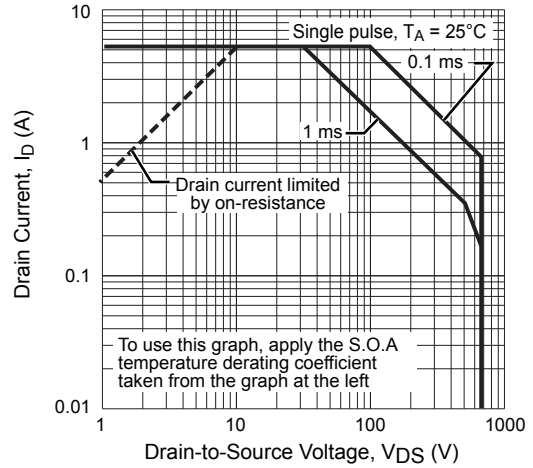

MOSFET Avalanche Energy Derating Coefficient Curve

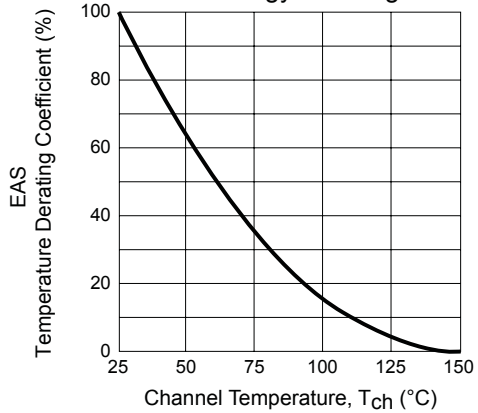

MOSFET Temperature versus Power Dissipation Curve

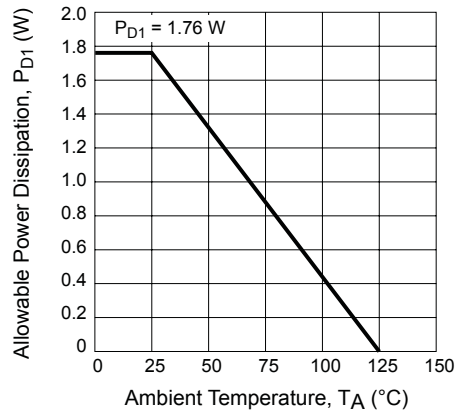

Transient Thermal Resistance Curve

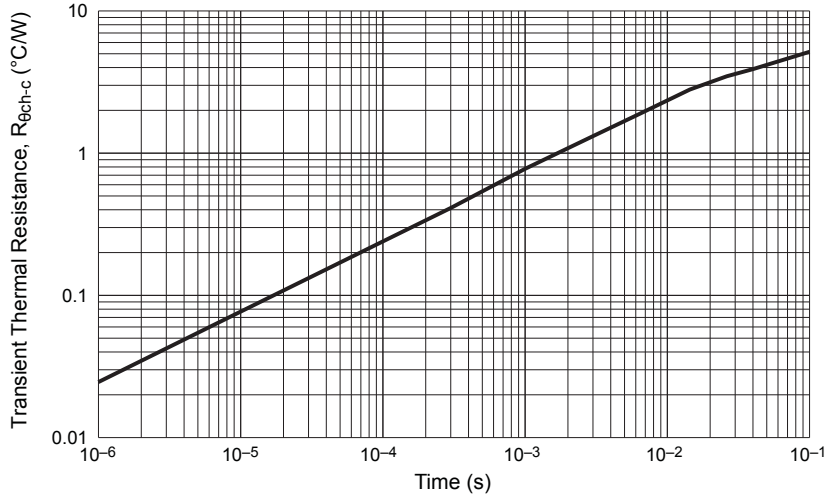

Characteristic Performance
STR3A154D

S. O. A. Temperature Derating Coefficient Curve

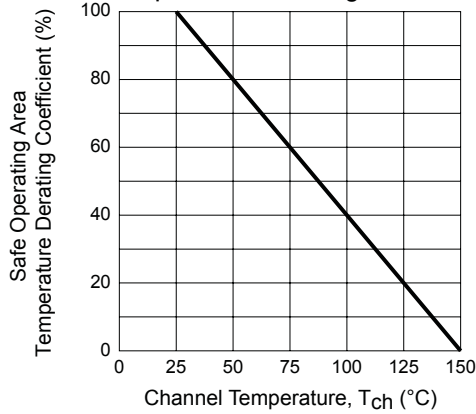

MOSFET Safe Operating Area Curve

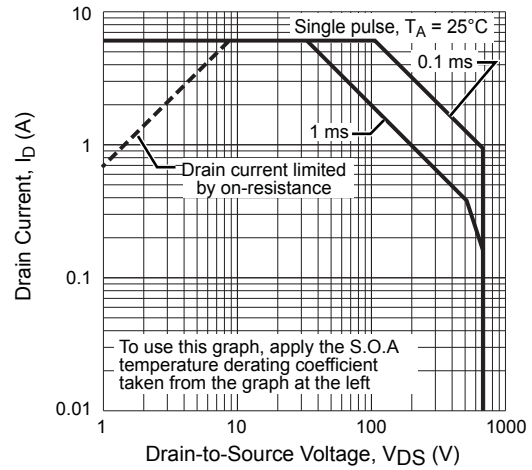

MOSFET Avalanche Energy Derating Coefficient Curve

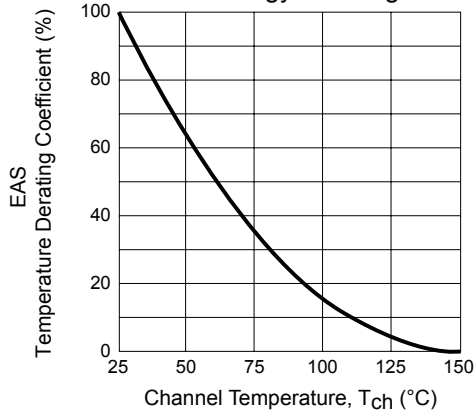

MOSFET Temperature versus Power Dissipation Curve

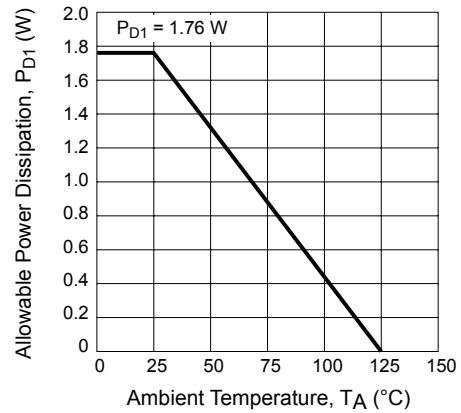

Transient Thermal Resistance Curve

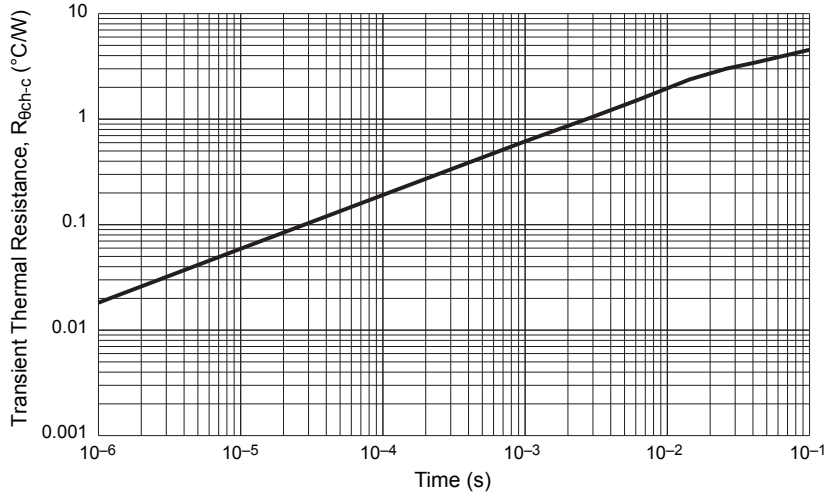

Characteristic Performance
STR3A155D

S. O. A. Temperature Derating Coefficient Curve

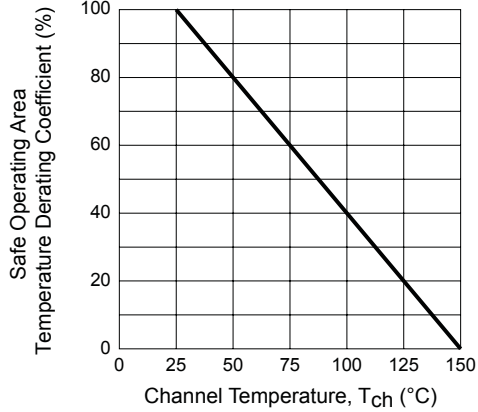

MOSFET Safe Operating Area Curve

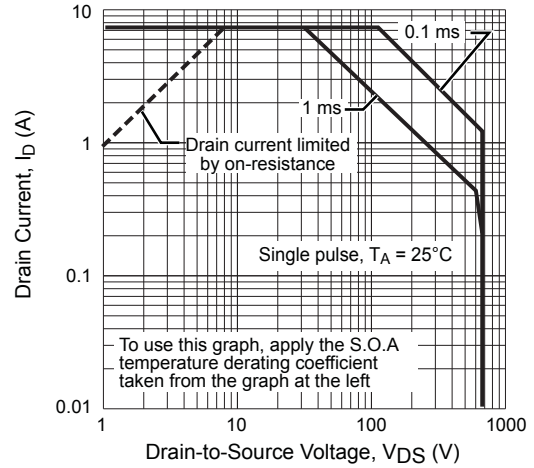

MOSFET Avalanche Energy Derating Coefficient Curve

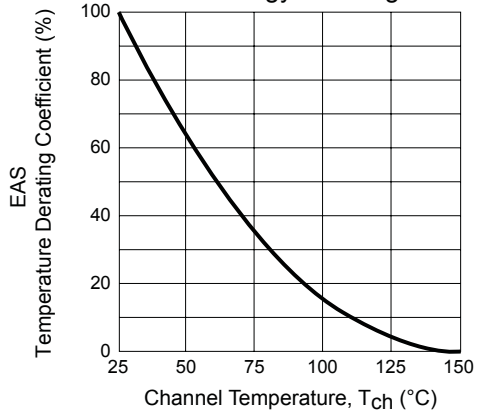

MOSFET Temperature versus Power Dissipation Curve

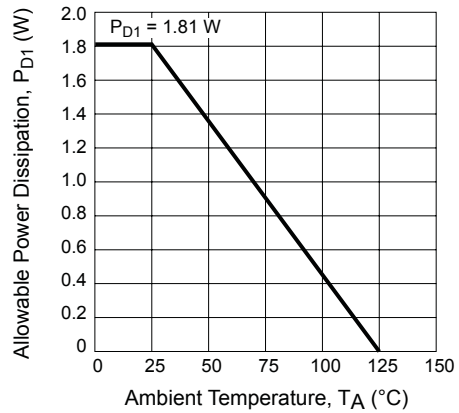

Transient Thermal Resistance Curve

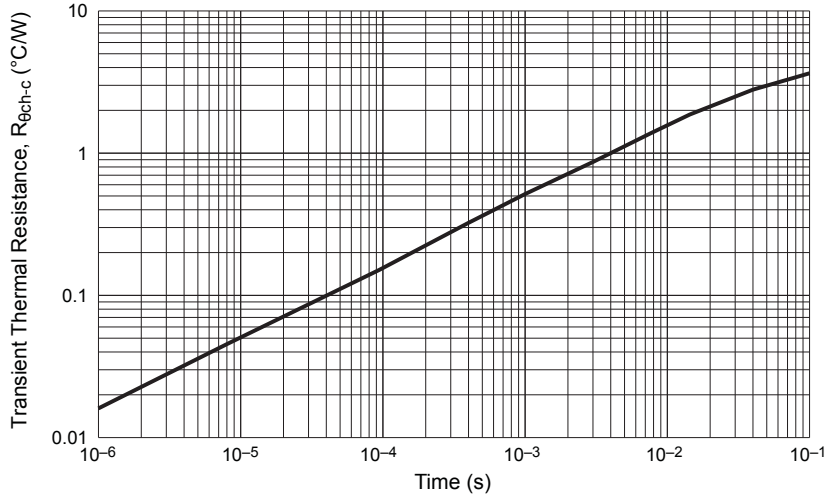

Functional Block Diagram

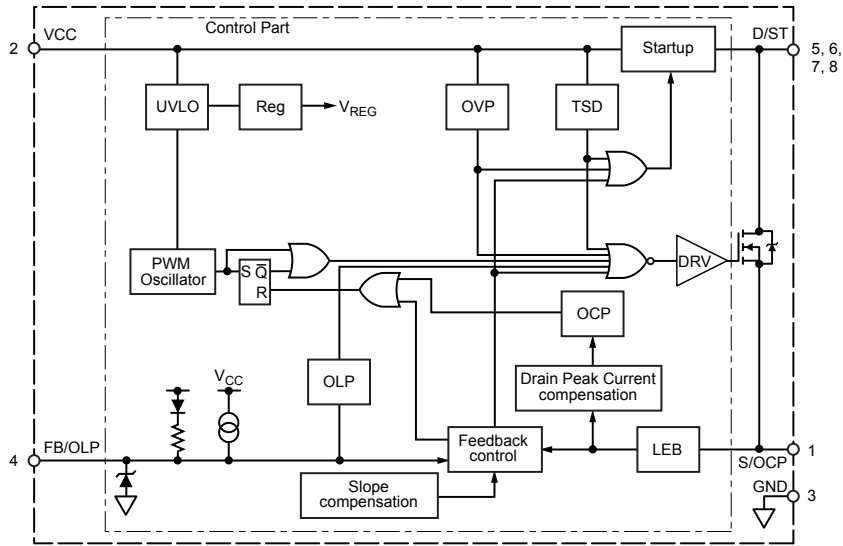

Pin-out Diagram

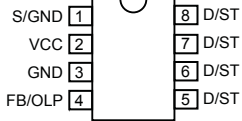

Pin List Table

| Number | Name | Function |
|------------|--------|---|
| 1 | S/OCP | MOSFET source and input of Overcurrent Protection (OCP) signal |
| 2 | VCC | Power supply voltage input for Control Part and input of Overvoltage Protection (OVP) signal |
| 3 | GND | Ground |
| 4 | FB/OLP | Feedback signal input for constant voltage control signal and input of Overload Protection (OLP) signal |
| 5, 6, 7, 8 | D/ST | MOSFET drain pin and input of the startup current |

Package Diagram
DIP8 package

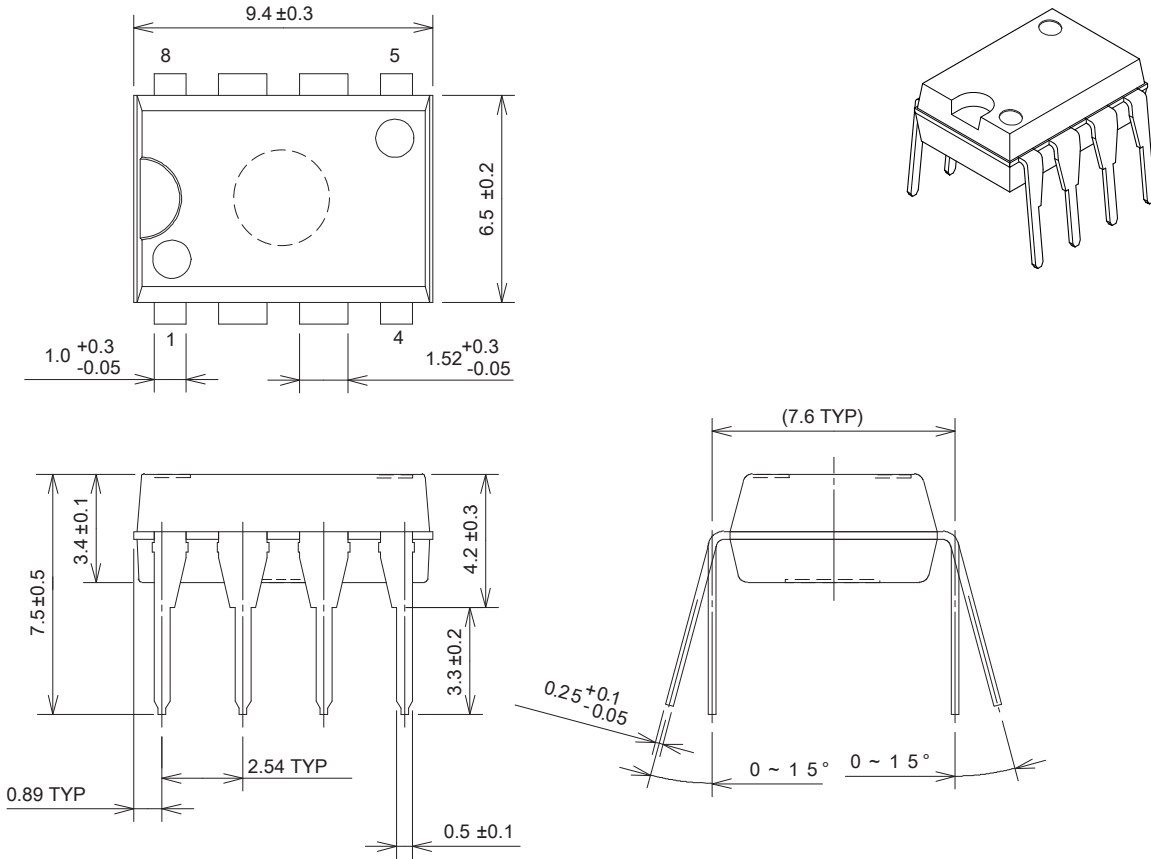

Unit: mm



Pb-free.
Device composition compliant
with the RoHS directive.

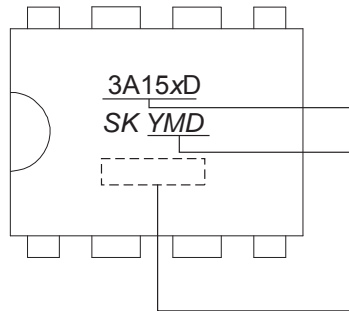

Part Number

Lot Number

Y is the last digit of the year (0 to 9)

M is the month (1 to 9, O, N, or D)

D is a period of days:

1 - 1st to 10th

2 - 11th to 20th

3 - 21st to 31st

Sanken Control Number

Because reliability can be affected adversely by improper storage environments and handling methods, please observe the following cautions.

Cautions for Storage

- Ensure that storage conditions comply with the standard temperature (5°C to 35°C) and the standard relative humidity (around 40% to 75%); avoid storage locations that experience extreme changes in temperature or humidity.
- Avoid locations where dust or harmful gases are present and avoid direct sunlight.
- Reinspect for rust on leads and solderability of the products that have been stored for a long time.

Cautions for Testing and Handling

When tests are carried out during inspection testing and other standard test periods, protect the products from power surges from the testing device, shorts between the product pins, and wrong connections. Ensure all test parameters are within the ratings specified by Sanken for the products.

Remarks About Using Silicone Grease with a Heatsink

- When silicone grease is used in mounting the products on a heatsink, it shall be applied evenly and thinly. If more silicone grease than required is applied, it may produce excess stress.
- Volatile-type silicone greases may crack after long periods of time, resulting in reduced heat radiation effect. Silicone greases with low consistency (hard grease) may cause cracks in the mold resin when screwing the products to a heatsink.

Our recommended silicone greases for heat radiation purposes, which will not cause any adverse effect on the product life, are indicated below:

| Type | Suppliers |
|--------|--------------------------------------|
| G746 | Shin-Etsu Chemical Co., Ltd. |
| YG6260 | Momentive Performance Materials Inc. |
| SC102 | Dow Corning Toray Co., Ltd. |

Soldering

- When soldering the products, please be sure to minimize the working time, within the following limits:
260±5°C 10±1 s (Flow, 2 times)
380±10°C 3.5±0.5 s (Soldering iron, 1 time)
- Soldering should be at a distance of at least 1.5 mm from the body of the products.

Electrostatic Discharge

- When handling the products, the operator must be grounded. Grounded wrist straps worn should have at least 1 MΩ of resistance from the operator to ground to prevent shock hazard, and it should be placed near the operator.
- Workbenches where the products are handled should be grounded and be provided with conductive table and floor mats.
- When using measuring equipment such as a curve tracer, the equipment should be grounded.
- When soldering the products, the head of soldering irons or the solder bath must be grounded in order to prevent leak voltages generated by them from being applied to the products.
- The products should always be stored and transported in Sanken shipping containers or conductive containers, or be wrapped in aluminum foil.

-
- The contents in this document are subject to changes, for improvement and other purposes, without notice. Make sure that this is the latest revision of the document before use.
 - Application and operation examples described in this document are quoted for the sole purpose of reference for the use of the products herein and Sanken can assume no responsibility for any infringement of industrial property rights, intellectual property rights or any other rights of Sanken or any third party which may result from its use.
 - Although Sanken undertakes to enhance the quality and reliability of its products, the occurrence of failure and defect of semiconductor products at a certain rate is inevitable. Users of Sanken products are requested to take, at their own risk, preventative measures including safety design of the equipment or systems against any possible injury, death, fires or damages to the society due to device failure or malfunction.
 - Sanken products listed in this document are designed and intended for the use as components in general purpose electronic equipment or apparatus (home appliances, office equipment, telecommunication equipment, measuring equipment, etc.).

When considering the use of Sanken products in the applications where higher reliability is required (transportation equipment and its control systems, traffic signal control systems or equipment, fire/crime alarm systems, various safety devices, etc.), and whenever long life expectancy is required even in general purpose electronic equipment or apparatus, please contact your nearest Sanken sales representative to discuss, prior to the use of the products herein.

The use of Sanken products without the written consent of Sanken in the applications where extremely high reliability is required (aerospace equipment, nuclear power control systems, life support systems, etc.) is strictly prohibited.

- In the case that you use Sanken products or design your products by using Sanken products, the reliability largely depends on the degree of derating to be made to the rated values. Derating may be interpreted as a case that an operation range is set by derating the load from each rated value or surge voltage or noise is considered for derating in order to assure or improve the reliability. In general, derating factors include electric stresses such as electric voltage, electric current, electric power etc., environmental stresses such as ambient temperature, humidity etc. and thermal stress caused due to self-heating of semiconductor products. For these stresses, instantaneous values, maximum values and minimum values must be taken into consideration.

In addition, it should be noted that since power devices or IC's including power devices have large self-heating value, the degree of derating of junction temperature affects the reliability significantly.

- When using the products specified herein by either (i) combining other products or materials therewith or (ii) physically, chemically or otherwise processing or treating the products, please duly consider all possible risks that may result from all such uses in advance and proceed therewith at your own responsibility.
- Anti radioactive ray design is not considered for the products listed herein.
- Sanken assumes no responsibility for any troubles, such as dropping products caused during transportation out of Sanken's distribution network.
- The contents in this document must not be transcribed or copied without Sanken's written consent.