



SANYO Semiconductors

DATA SHEET

An ON Semiconductor Company

TIG067SS — N-Channel IGBT Light-Controlling Flash Applications

Features

- Low-saturation voltage
- Enhancement type
- High speed switching
- 4.0V drive
- Built-in Gate-to-Emitter protection diode
- Halogen free compliance

Specifications

Absolute Maximum Ratings at Ta=25°C

Parameter	Symbol	Conditions	Ratings	Unit
Collector-to-Emitter Voltage (DC)	V _{CES}		400	V
Collector-to-Emitter Voltage (Pulse)	V _{CESP}	PW≤1ms	450	V
Gate-to-Emitter Voltage (DC)	V _{GES}		±6	V
Gate-to-Emitter Voltage (Pulse)	V _{GESP}	PW≤1ms	±8	V
Collector Current (Pulse)	I _{CP}	C _M =600μF	150	A
Maximum Collector-to-Emitter dv / dt	dv / dt	V _{CE} ≤320V, starting Tch=25°C	1500	V / μs
Allowable Power Dissipation	P _D	When mounted on FR4 substrate (11,680mm ² ×1.6mm)	1.2	W
Channel Temperature	T _{ch}		150	°C
Storage Temperature	T _{stg}		-40 to +150	°C

Package Dimensions

unit : mm (typ)

7072-002

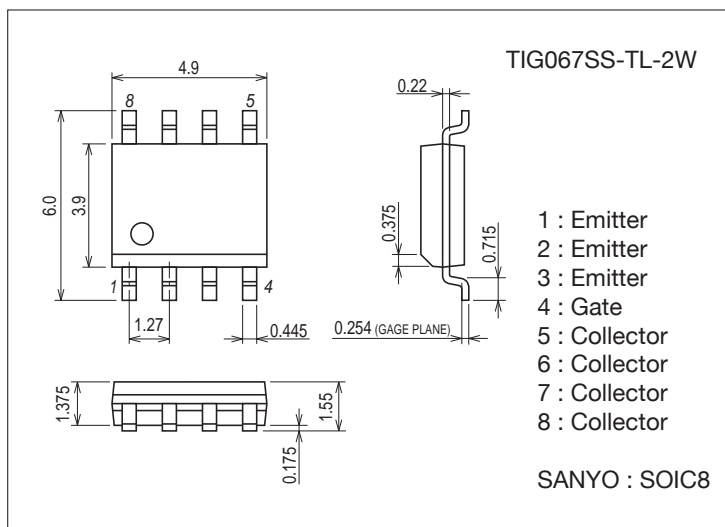

Product & Package Information

- Package : SOIC8
- JEITA, JEDEC : SC-87, SOT-96
- Minimum Packing Quantity : 2500 pcs./reel

Packing Type: TL

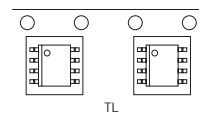

Marking

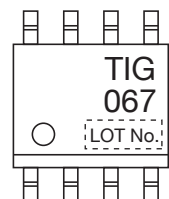

Electrical Connection

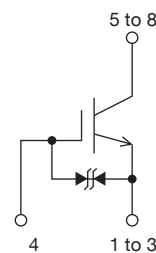

TIG067SS

Electrical Characteristics at Ta=25°C

Parameter	Symbol	Conditions	Ratings			Unit
			min	typ	max	
Collector-to-Emitter Breakdown Voltage	V(BR)CES	IC=2mA, VGE=0V	400			V
Collector-to-Emitter Cutoff Current	ICES	VCE=320V, VGE=0V			10	μA
Gate-to-Emitter Leakage Current	IGES	VGE=±6V, VCE=0V			±10	μA
Gate-to-Emitter Threshold Voltage	VGE(off)	VCE=10V, IC=1mA	0.4		1.0	V
Collector-to-Emitter Saturation Voltage	VCE(sat)	IC=150A, VGE=4V		3.8	5	V
Input Capacitance	Cies	VCE=10V, f=1MHz		5100		pF
Output Capacitance	Coes				59	pF
Reverse Transfer Capacitance	Cres				43	pF
Fall Time	tf	IC=150A, VCC=320V, Resistor load VGE=4V, RG=36Ω		270		ns

Fig1 Large Current R Load Switching Circuit

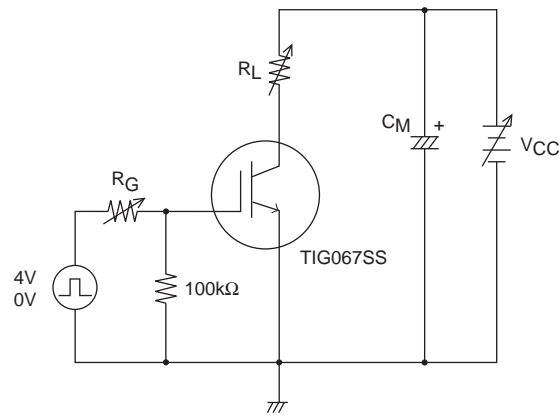

Note1. Gate Series Resistance $R_G \geq 36\Omega$ is recommended for protection purpose at the time of turn OFF. However, if $dv / dt \leq 1500 / \mu s$ is satisfied at customer's actual set evaluation, $R_G < 36\Omega$ can also be used.

Note2. The collector voltage gradient dv / dt must be smaller than $1500V / \mu s$ to protect the device when it is turned off.

Ordering Information

Device	Package	Shipping	memo
TIG067SS-TL-2W	SOIC8	2,500pcs./reel	Pb Free and Halogen Free

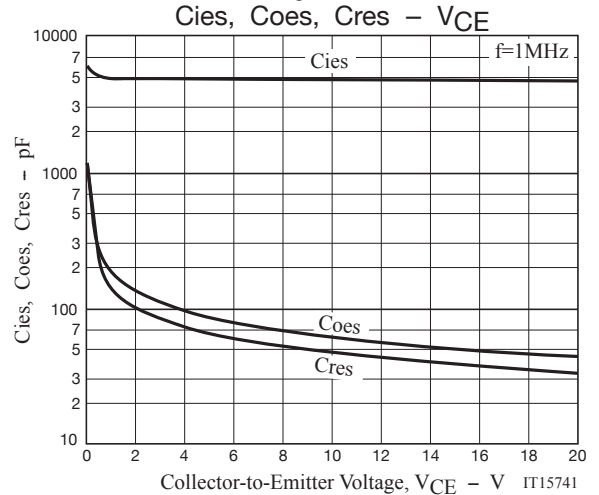
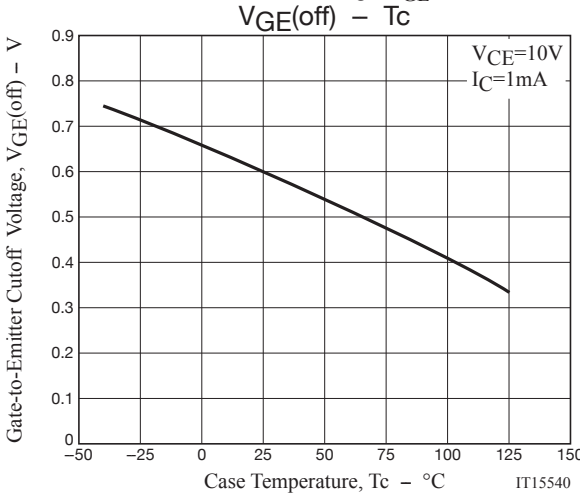
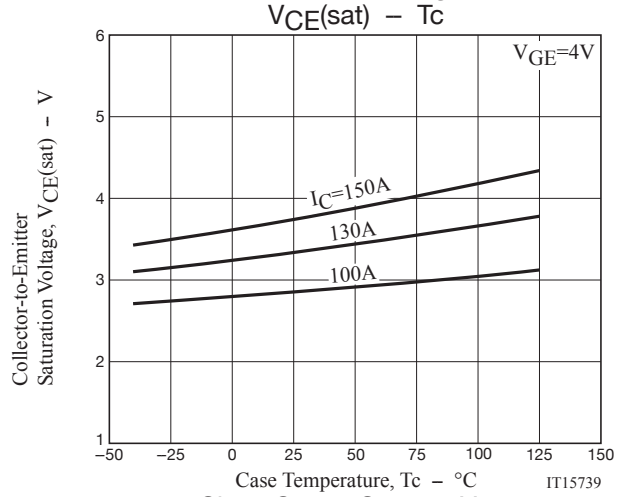
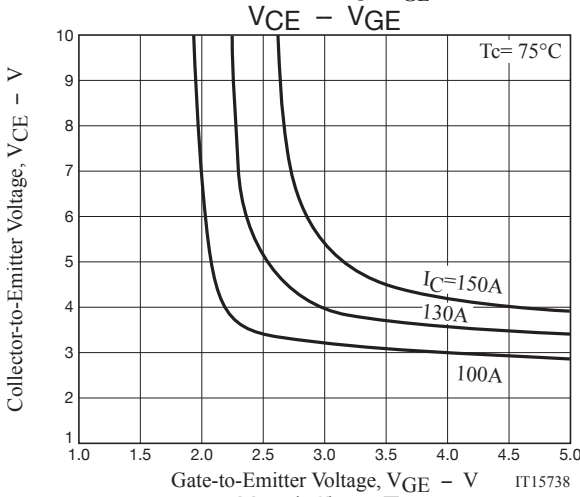
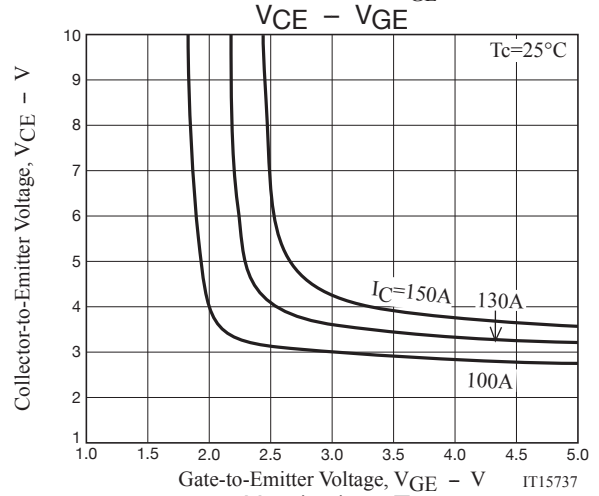
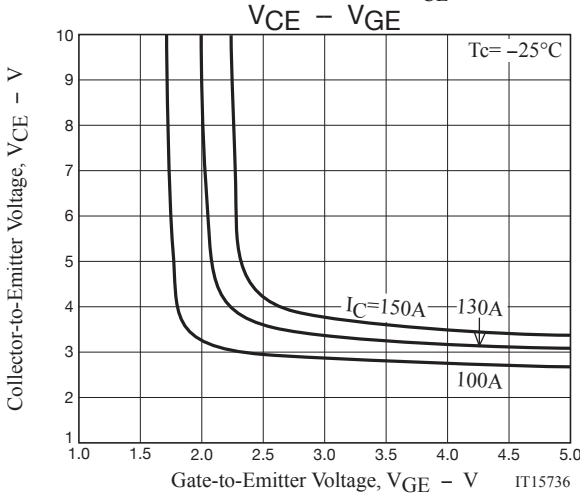
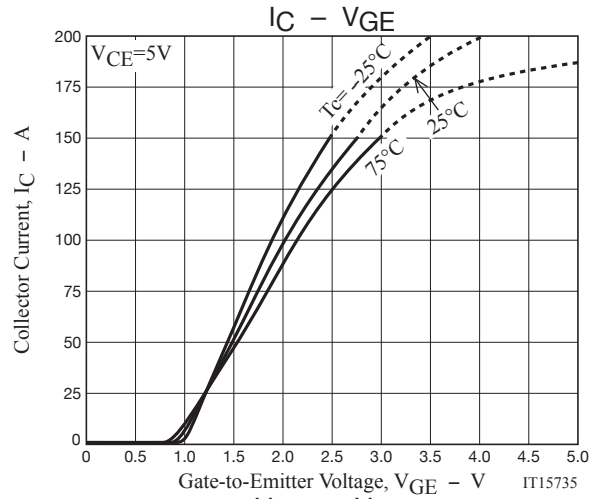
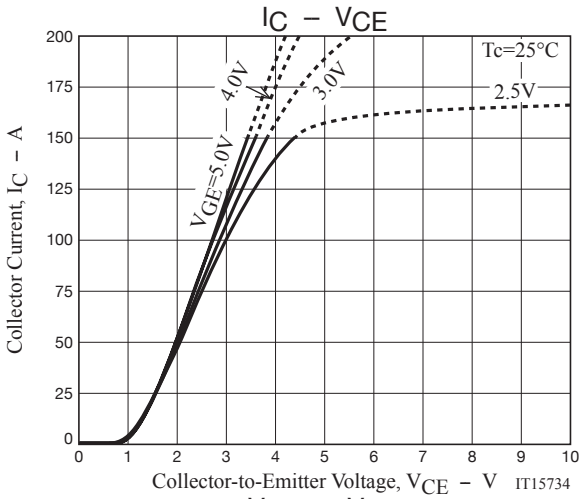

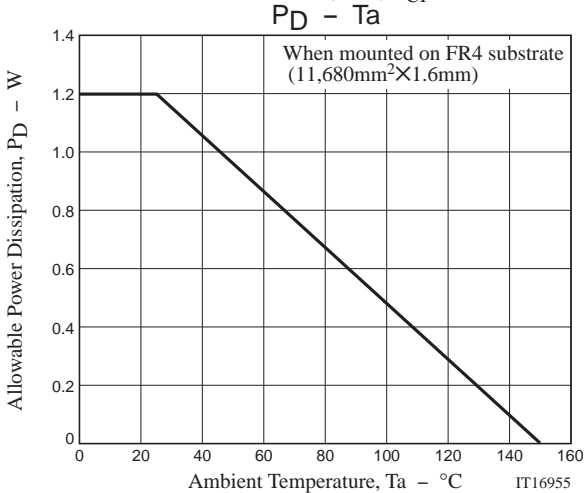
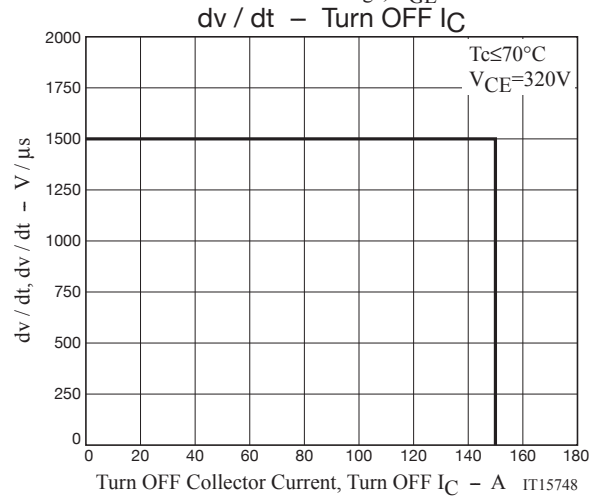
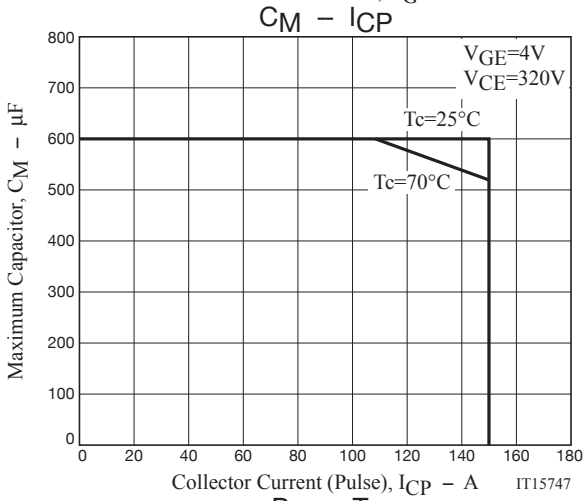
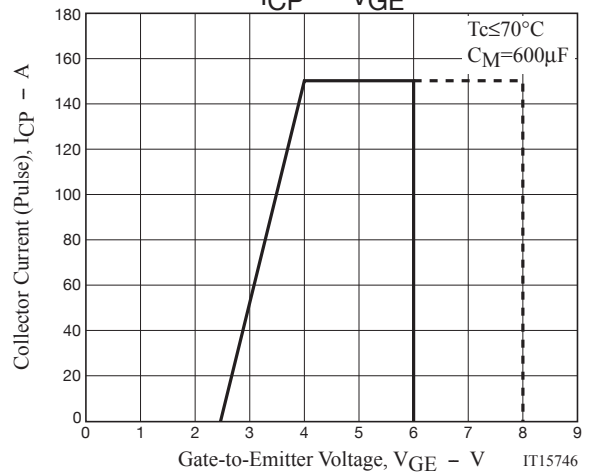
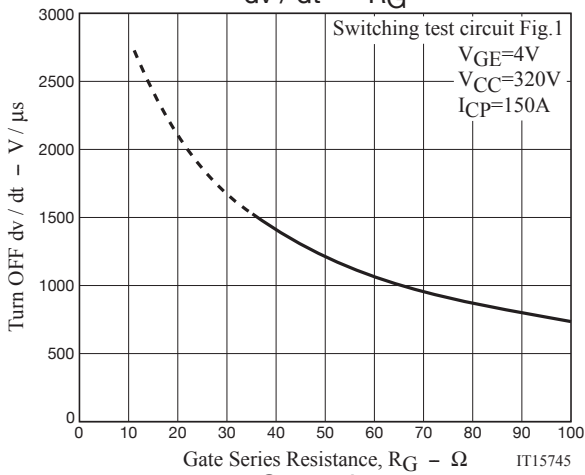
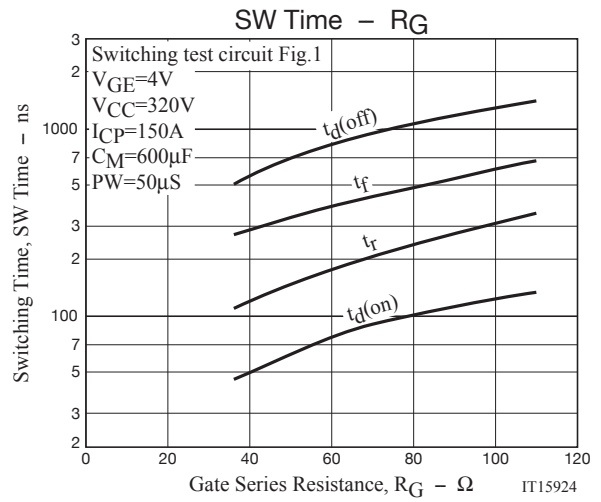
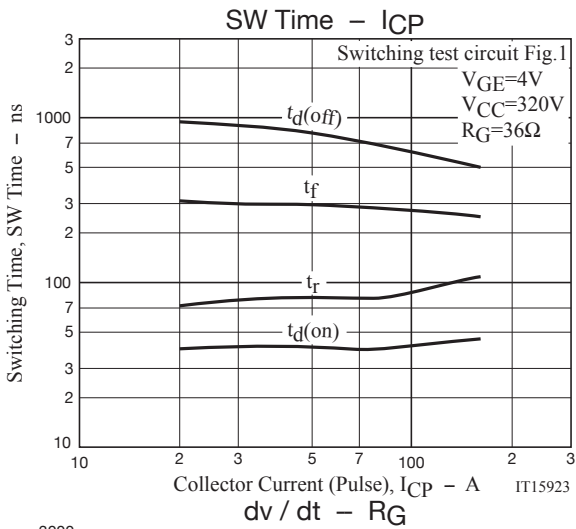

Definition of dv/dt

dv/dt is defined as the maximum slope of the below V_{CE} curve during turn-off period.
 $dv/dt = \Delta V_{CE} / \Delta t = \Delta V_{CE} / 100ns$

Overall waveform

Enlarged picture of turn-off period

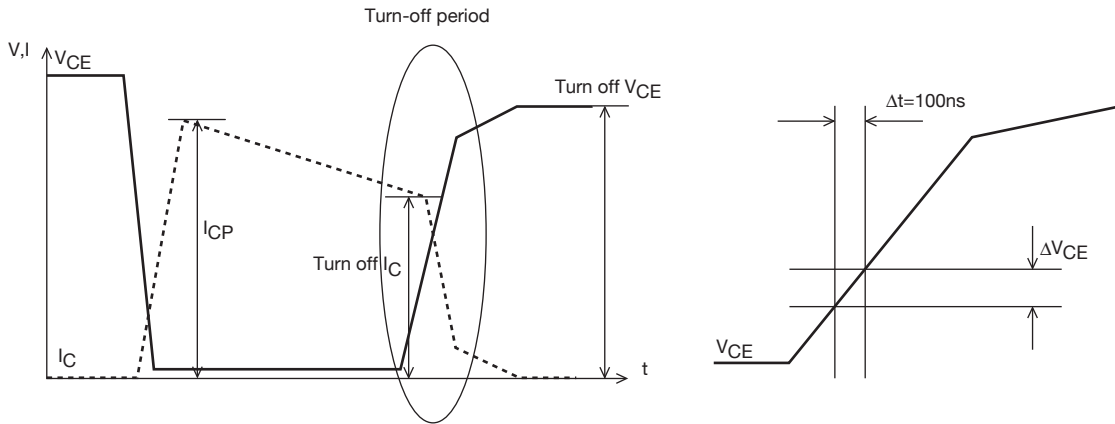

Definition of Switching Time

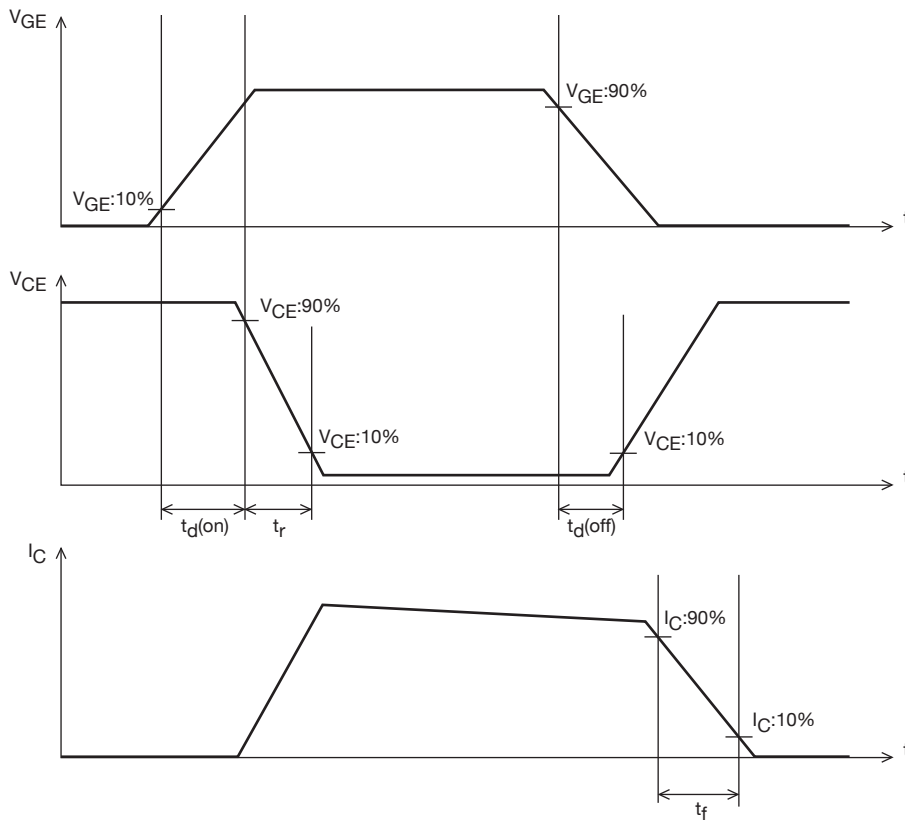

TIG067SS

Taping Specification

TIG067SS-TL-2W

1. Packing Format

Package Name	Carrier Tape Type	Maximum Number of devices contained (pcs)			Packing format	
		Reel	Inner box	Outer box	Inner BOX W206-112	Outer BOX W207-124
SOIC8	B202-101	2,500	12,500	25,000	5 reels contained Dimensions :mm(external) 340×95×340	2 inner boxes contained Dimensions :mm(external) 360×210×375

Packing method

Reel label, Inner box label (unit: mm)

Outer box label

It is a label at the time of factory shipments.
The form of a label may change in physical distribution process.

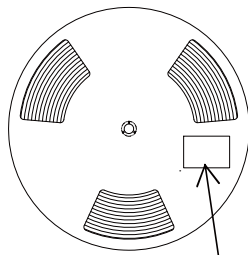

Type No. →
LOT No. →
Quantity →
Origin →

Reel label

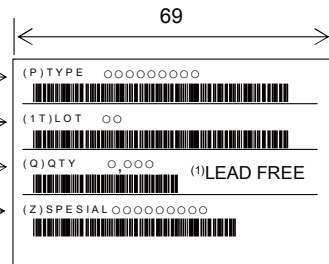

NOTE(1)

The LEAD FREE 4 description shows that it is complete lead free.

43
80

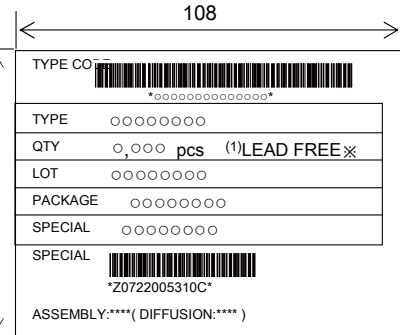

Label	JEITA Phase
LEAD FREE 4	JEITA Phase 3

2. Taping configuration

2-1. Carrier tape size (unit: mm)

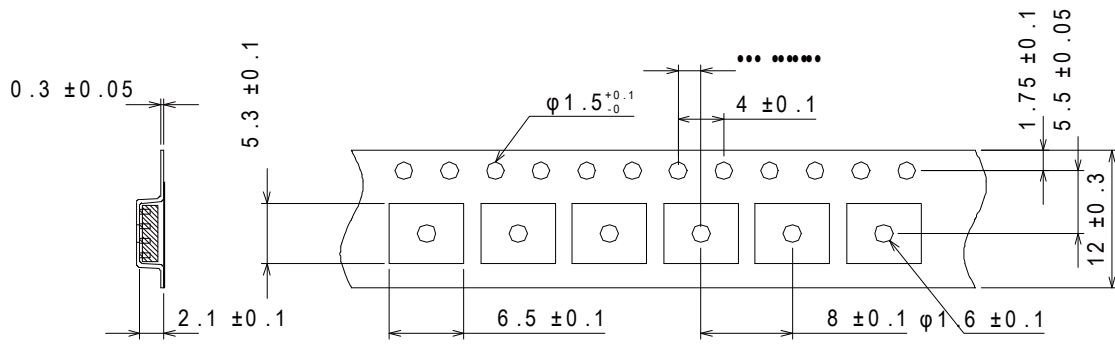

2-2. Device placement direction

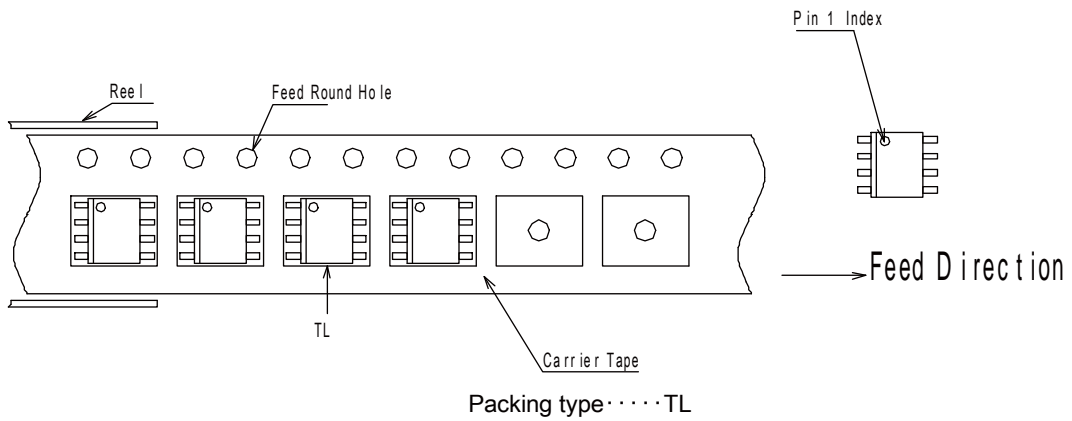

2-3. Leader portion and trailer portion (unit: mm)

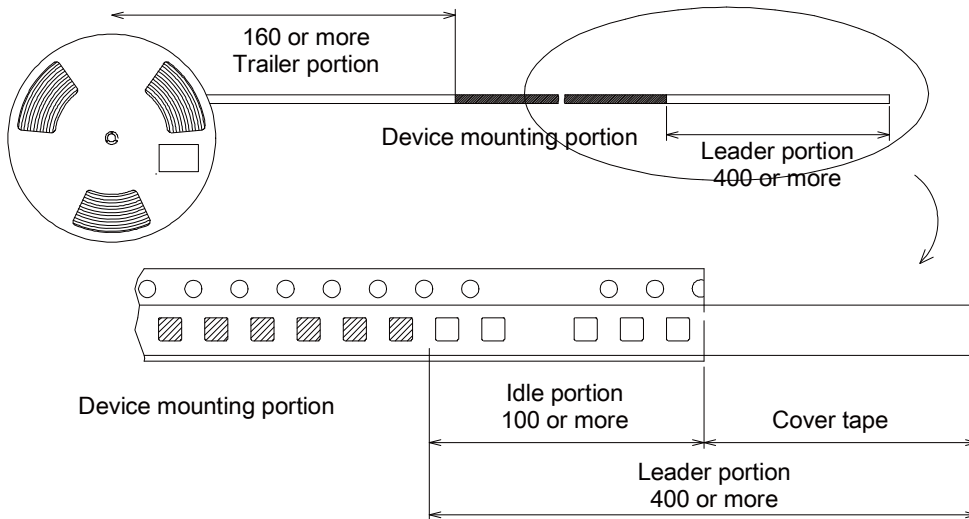

TIG067SS

Outline Drawing TIG067SS-TL-2W

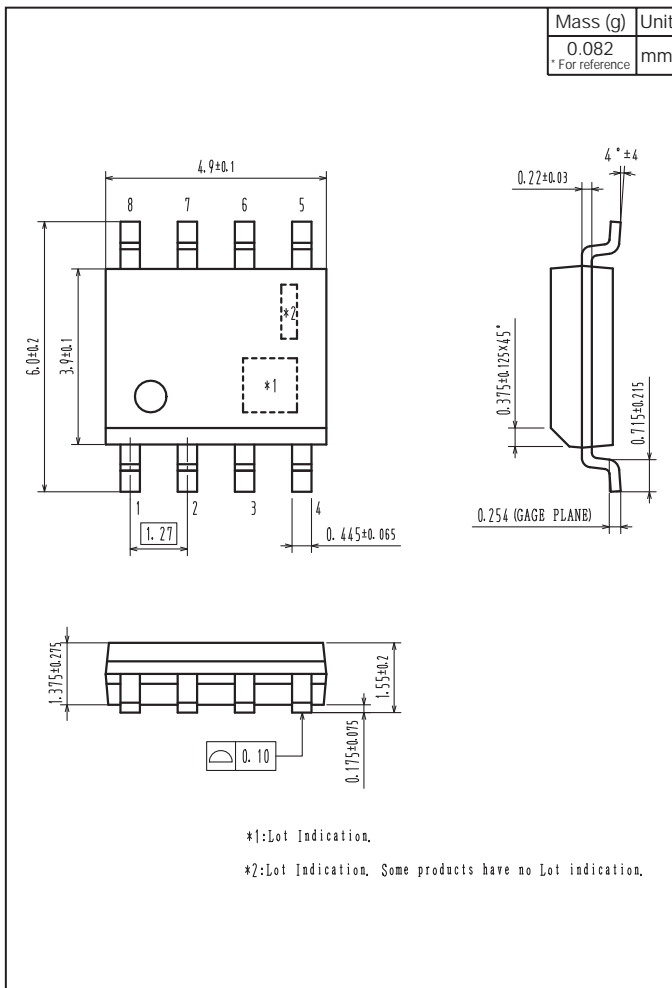

Land Pattern Example

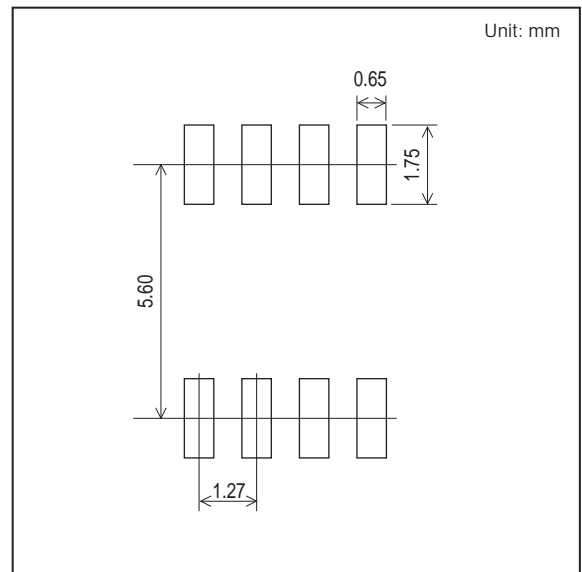

Note : TIG067SS has protection diode between gate and emitter but handling it requires sufficient care to be taken.

- Any and all SANYO Semiconductor Co.,Ltd. products described or contained herein are, with regard to "standard application", intended for the use as general electronics equipment. The products mentioned herein shall not be intended for use for any "special application" (medical equipment whose purpose is to sustain life, aerospace instrument, nuclear control device, burning appliances, transportation machine, traffic signal system, safety equipment etc.) that shall require extremely high level of reliability and can directly threaten human lives in case of failure or malfunction of the product or may cause harm to human bodies, nor shall they grant any guarantee thereof. If you should intend to use our products for new introduction or other application different from current conditions on the usage of automotive device, communication device, office equipment, industrial equipment etc. , please consult with us about usage condition (temperature, operation time etc.) prior to the intended use. If there is no consultation or inquiry before the intended use, our customer shall be solely responsible for the use.
- Specifications of any and all SANYO Semiconductor Co.,Ltd. products described or contained herein stipulate the performance, characteristics, and functions of the described products in the independent state, and are not guarantees of the performance, characteristics, and functions of the described products as mounted in the customer's products or equipment. To verify symptoms and states that cannot be evaluated in an independent device, the customer should always evaluate and test devices mounted in the customer's products or equipment.
- SANYO Semiconductor Co.,Ltd. assumes no responsibility for equipment failures that result from using products at values that exceed, even momentarily, rated values (such as maximum ratings, operating condition ranges, or other parameters) listed in products specifications of any and all SANYO Semiconductor Co.,Ltd. products described or contained herein.
- Regarding monolithic semiconductors, if you should intend to use this IC continuously under high temperature, high current, high voltage, or drastic temperature change, even if it is used within the range of absolute maximum ratings or operating conditions, there is a possibility of decrease reliability. Please contact us for a confirmation.
- SANYO Semiconductor Co.,Ltd. strives to supply high-quality high-reliability products, however, any and all semiconductor products fail or malfunction with some probability. It is possible that these probabilistic failures or malfunction could give rise to accidents or events that could endanger human lives, trouble that could give rise to smoke or fire, or accidents that could cause damage to other property. When designing equipment, adopt safety measures so that these kinds of accidents or events cannot occur. Such measures include but are not limited to protective circuits and error prevention circuits for safe design, redundant design, and structural design.
- In the event that any or all SANYO Semiconductor Co.,Ltd. products described or contained herein are controlled under any of applicable local export control laws and regulations, such products may require the export license from the authorities concerned in accordance with the above law.
- No part of this publication may be reproduced or transmitted in any form or by any means, electronic or mechanical, including photocopying and recording, or any information storage or retrieval system, or otherwise, without the prior written consent of SANYO Semiconductor Co.,Ltd.
- Any and all information described or contained herein are subject to change without notice due to product/technology improvement, etc. When designing equipment, refer to the "Delivery Specification" for the SANYO Semiconductor Co.,Ltd. product that you intend to use.
- Upon using the technical information or products described herein, neither warranty nor license shall be granted with regard to intellectual property rights or any other rights of SANYO Semiconductor Co.,Ltd. or any third party. SANYO Semiconductor Co.,Ltd. shall not be liable for any claim or suits with regard to a third party's intellectual property rights which has resulted from the use of the technical information and products mentioned above.

This catalog provides information as of October, 2012. Specifications and information herein are subject to change without notice.