

**N-Channel Logic Level Enhancement Mode Power MOSFET**

# MTB06N03Q8

BV <sub>DSS</sub>	30V
I <sub>D</sub>	18A
R <sub>DS(on)(max)</sub>	6.8mΩ

**Description**

The MTB06N03Q8 is a N-channel enhancement-mode MOSFET, providing the designer with the best combination of fast switching, ruggedized device design, low on-resistance and cost effectiveness. The SOP-8 package is universally preferred for all commercial-industrial surface mount applications and suited for low voltage applications such as DC/DC converters.

**Features**

- Single Drive Requirement
- Low On-resistance
- Fast Switching Characteristic
- Dynamic dv/dt rating
- Repetitive Avalanche Rated
- Pb-free and Halogen-free package

**Symbol**

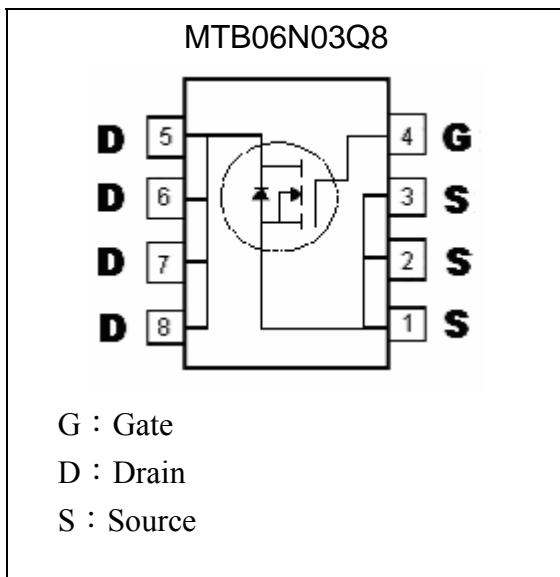

**Outline**

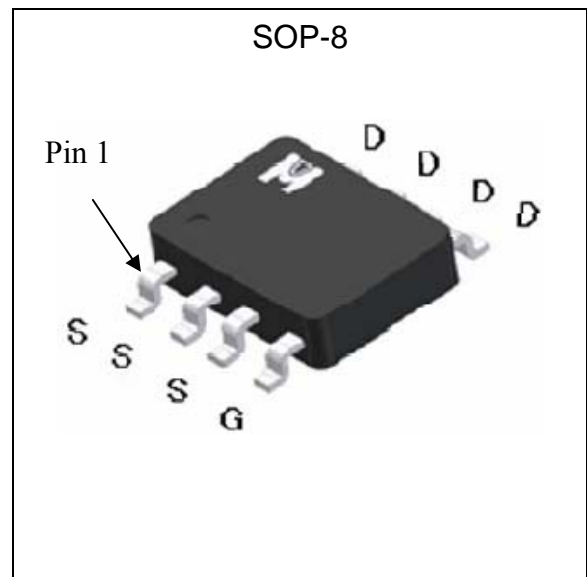



**Absolute Maximum Ratings** (Ta=25°C)

Parameter	Symbol	Limits	Unit	
Drain-Source Voltage	V <sub>DS</sub>	30	V	
Gate-Source Voltage	V <sub>GS</sub>	±20		
Continuous Drain Current @ T <sub>c</sub> =25°C	I <sub>D</sub>	18	A	
Continuous Drain Current @ T <sub>c</sub> =100°C		12		
Pulsed Drain Current	I <sub>DM</sub>	72 *1		
Avalanche Current	I <sub>AS</sub>	20		
Avalanche Energy @ L=0.1mH, I <sub>D</sub> =20A, R <sub>G</sub> =25 Ω	E <sub>AS</sub>	20	mJ	
Repetitive Avalanche Energy @ L=0.05mH	E <sub>AR</sub>	10 *2		
Total Power Dissipation	P <sub>D</sub>	T <sub>A</sub> =25°C	3	W
		T <sub>A</sub> =100°C	1.5	
Operating Junction and Storage Temperature Range	T <sub>j</sub> , T <sub>stg</sub>	-55~+175	°C	

**Thermal Data**

Parameter	Symbol	Value	Unit
Thermal Resistance, Junction-to-case, max	R <sub>th,j-c</sub>	25	°C/W
Thermal Resistance, Junction-to-ambient, max	R <sub>th,j-a</sub>	50 *3	°C/W

- Note : 1. Pulse width limited by maximum junction temperature  
 2. Duty cycle ≤ 1%  
 3. Surface mounted on 1 in<sup>2</sup> copper pad of FR-4 board, 125°C/W when mounted on minimum copper pad

**Characteristics (T<sub>c</sub>=25°C, unless otherwise specified)**

Symbol	Min.	Typ.	Max.	Unit	Test Conditions
<b>Static</b>					
BV <sub>DSS</sub>	30	-	-	V	V <sub>GS</sub> =0, I <sub>D</sub> =250μA
V <sub>GS(th)</sub>	1.0	1.5	3.0	V	V <sub>DS</sub> = V <sub>GS</sub> , I <sub>D</sub> =250μA
G <sub>FS</sub> *1	-	25	-	S	V <sub>DS</sub> =5V, I <sub>D</sub> =18A
I <sub>GSS</sub>	-	-	±100	nA	V <sub>GS</sub> =±20
I <sub>DSS</sub>	-	-	1	μA	V <sub>DS</sub> =24V, V <sub>GS</sub> =0
	-	-	25		V <sub>DS</sub> =20V, V <sub>GS</sub> =0, T <sub>j</sub> =125°C
I <sub>D(ON)</sub> *1	12	-	-	A	V <sub>DS</sub> =10V, V <sub>GS</sub> =10V
R <sub>DS(ON)</sub> *1	-	6	6.8	mΩ	V <sub>GS</sub> =10V, I <sub>D</sub> =18A
	-	9.2	11.8	mΩ	V <sub>GS</sub> =4.5V, I <sub>D</sub> =12A
<b>Dynamic</b>					
C <sub>iss</sub>	-	4753	-	pF	V <sub>GS</sub> =0V, V <sub>DS</sub> =15V, f=1MHz
C <sub>oss</sub>	-	495	-		
C <sub>rss</sub>	-	348	-		



**Characteristics (Tc=25°C, unless otherwise specified)**

Symbol	Min.	Typ.	Max.	Unit	Test Conditions
Qg (VGS=10V) *1, 2	-	53	-	nC	VDS=15V, VGS=10V, ID=18A
Qg (VGS=4.5V) *1, 2	-	30	-		
Qgs *1, 2	-	8	-		
Qgd *1, 2	-	17	-		
td(ON) *1, 2	-	22	-	ns	VDS=15V, ID=1A, VGS=10V, RGS=2.7Ω
tr *1, 2	-	16	-		
td(OFF) *1, 2	-	65	-		
tf *1, 2	-	10	-		
Rg	-	1.2	-	Ω	VGS=15mV, VDS=0V, f=1MHz
<b>Source-Drain Diode</b>					
IS *1	-	-	4	A	
ISM *3	-	-	40		
VSD *1	-	-	1.2	V	IF=IS, VGS=0V
trr	-	32	-	ns	IF=IS, dIF/dt=100A/μs
Qrr	-	12	-	nC	

Note : \*1.Pulse Test : Pulse Width ≤300μs, Duty Cycle≤2%  
 \*2.Independent of operating temperature  
 \*3.Pulse width limited by maximum junction temperature.

**Ordering Information**

Device	Package	Shipping	Marking
MTB06N03Q8	SOP-8 (Pb-free & Halogen-free package)	3000 pcs / Tape & Reel	B06N03

## Characteristic Curves

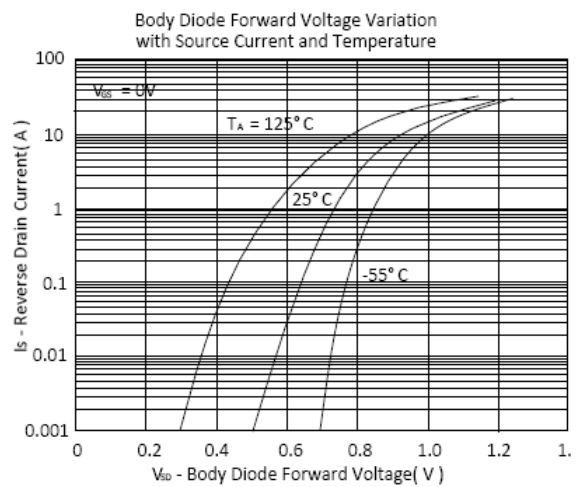
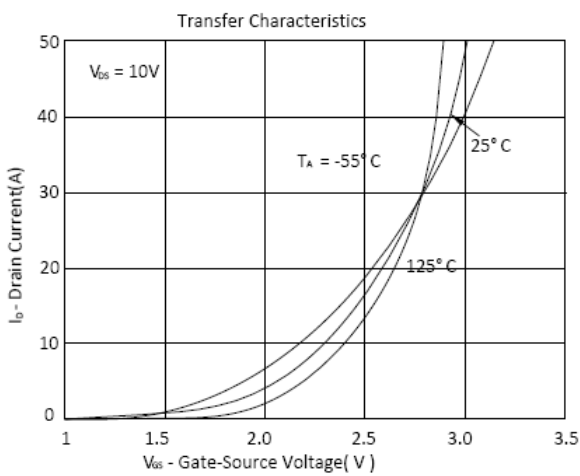
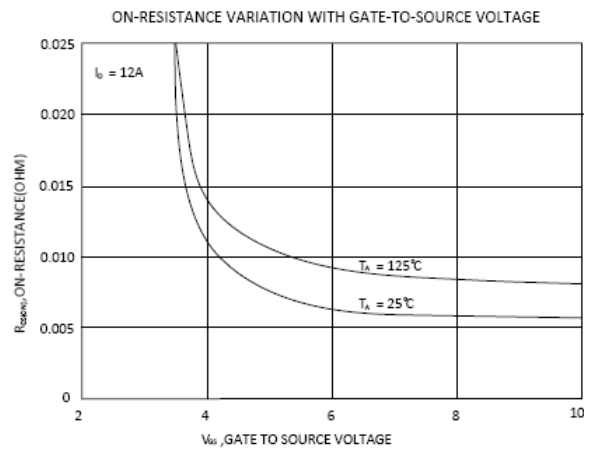
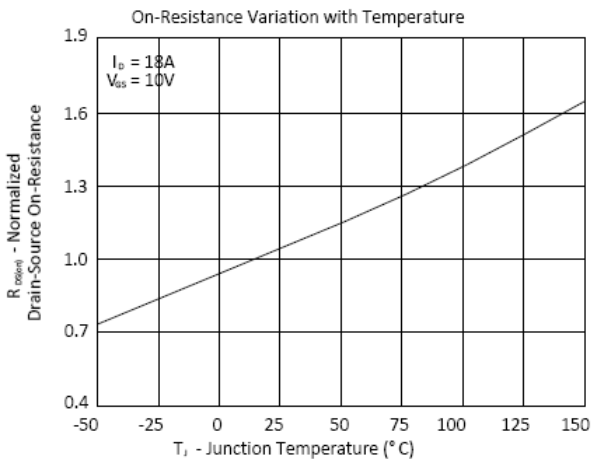
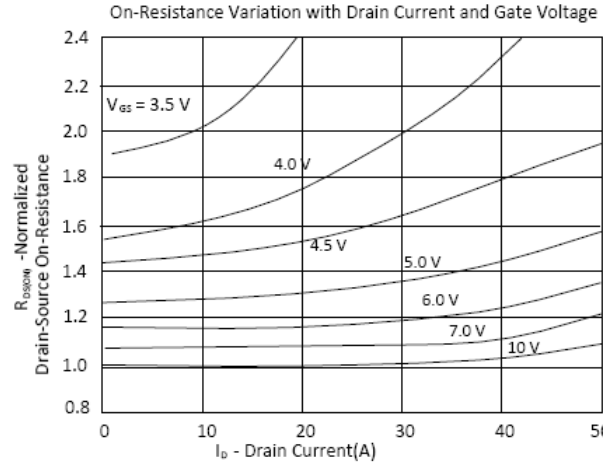
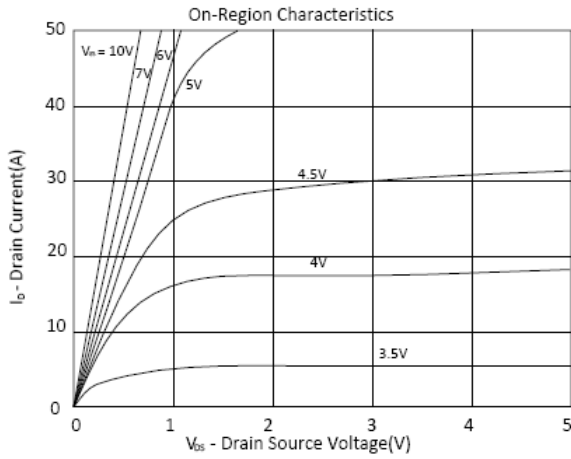



**Characteristic Curves(Cont.)**

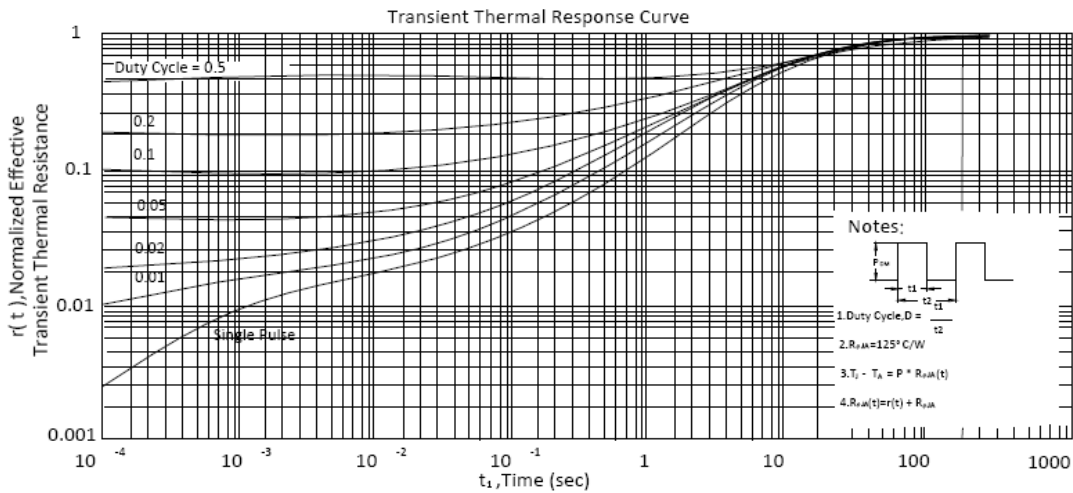
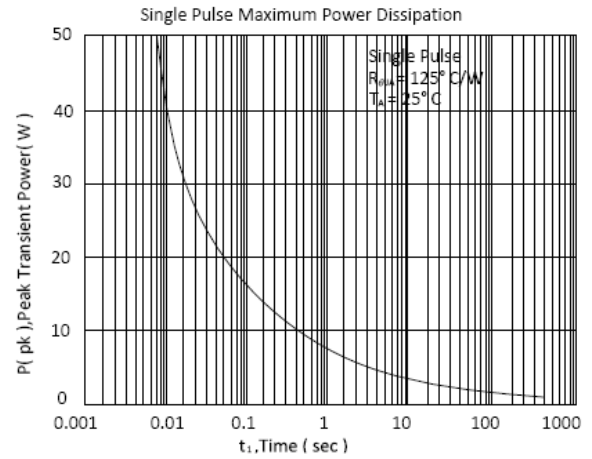
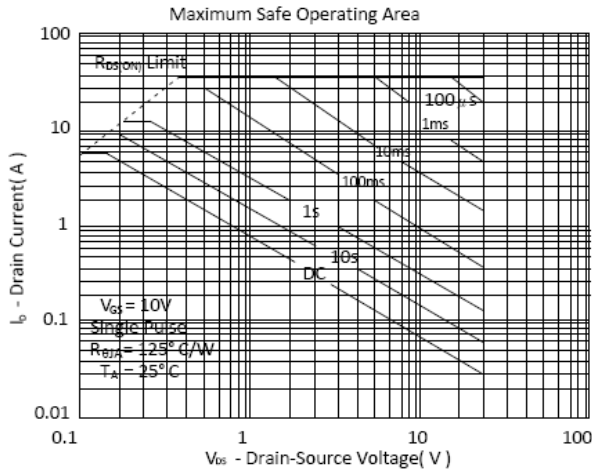
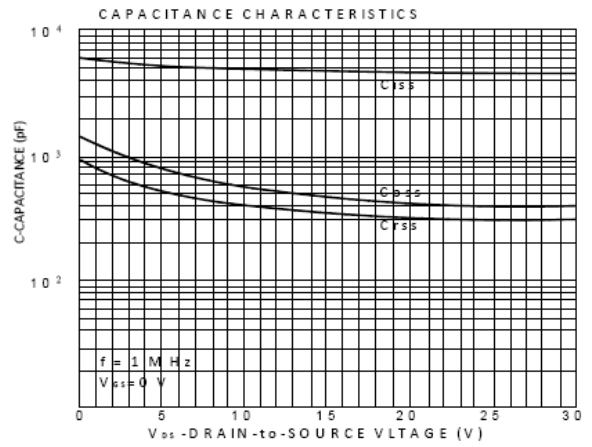
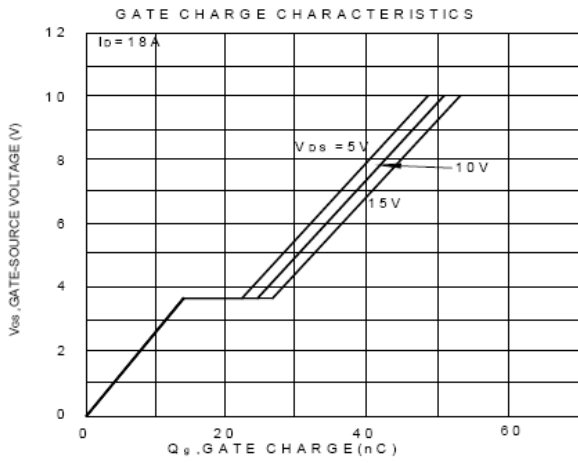

**SOP-8 Dimension**

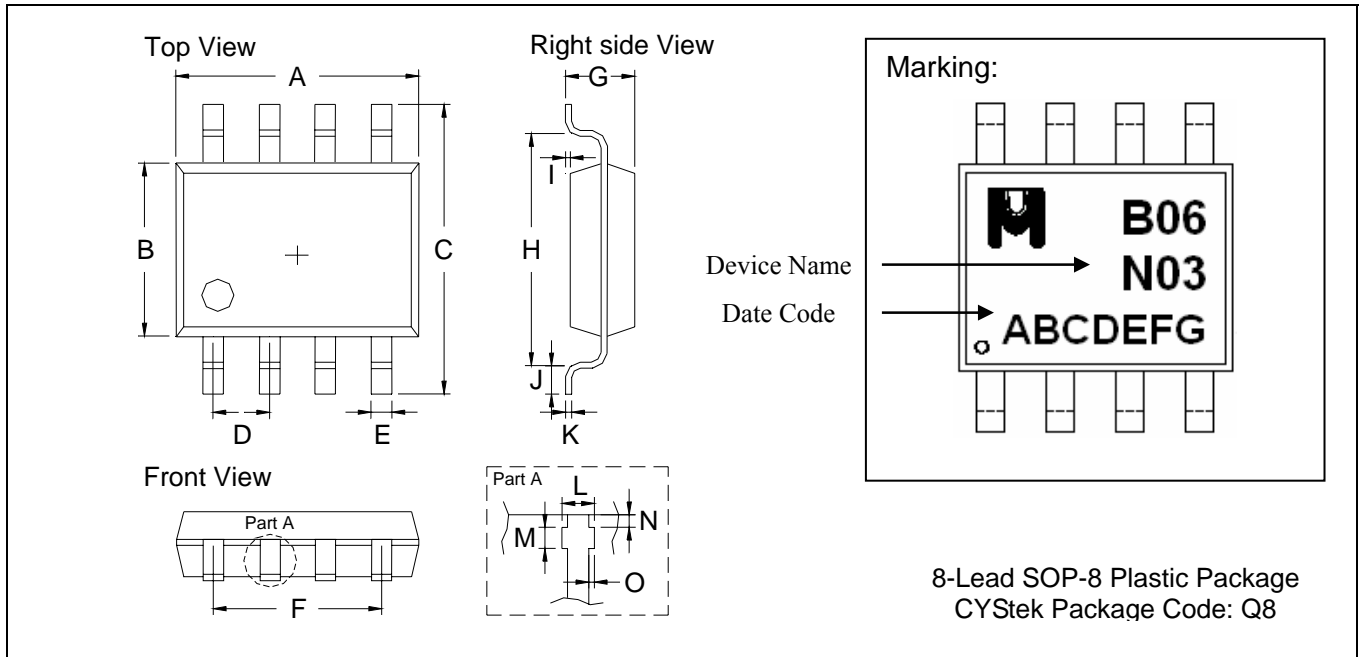

\*: Typical

DIM	Inches		Millimeters		DIM	Inches		Millimeters	
	Min.	Max.	Min.	Max.		Min.	Max.	Min.	Max.
A	0.1909	0.2007	4.85	5.10	I	0.0019	0.0078	0.05	0.20
B	0.1515	0.1555	3.85	3.95	J	0.0118	0.0275	0.30	0.70
C	0.2283	0.2441	5.80	6.20	K	0.0074	0.0098	0.19	0.25
D	0.0480	0.0519	1.22	1.32	L	0.0145	0.0204	0.37	0.52
E	0.0145	0.0185	0.37	0.47	M	0.0118	0.0197	0.30	0.50
F	0.1472	0.1527	3.74	3.88	N	0.0031	0.0051	0.08	0.13
G	0.0570	0.0649	1.45	1.65	O	0.0000	0.0059	0.00	0.15
H	0.1889	0.2007	4.80	5.10					

**Notes:** 1.Controlling dimension: millimeters.  
 2.Maximum lead thickness includes lead finish thickness, and minimum lead thickness is the minimum thickness of base material.  
 3.If there is any question with packing specification or packing method, please contact your local CYStek sales office.

**Material:**

- Lead: pure tin plated
- Mold Compound: Epoxy resin family, flammability solid burning class: UL94V-0

**Important Notice:**

- All rights are reserved. Reproduction in whole or in part is prohibited without the prior written approval of CYStek.
- CYStek reserves the right to make changes to its products without notice.
- CYStek **semiconductor products are not warranted to be suitable for use in Life-Support Applications, or systems.**
- CYStek assumes no liability for any consequence of customer product design, infringement of patents, or application assistance.