

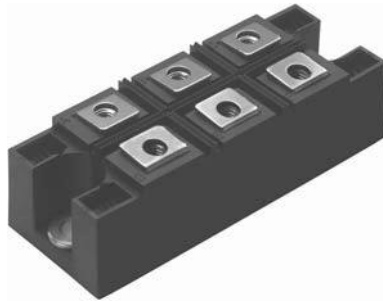

## Three Phase Bridge (Power Module), 200 A



MTK

### FEATURES

- Package fully compatible with the industry standard INT-A-PAK power modules series
- High thermal conductivity package, electrically insulated case
- Low power loss
- Excellent power volume ratio, outline for easy connections to power transistor and IGBT modules
- 4000  $V_{RMS}$  isolating voltage
- UL E78996 approved 
- Totally lead (Pb)-free
- Designed and qualified for industrial level

**RoHS**  
COMPLIANT

### PRODUCT SUMMARY

$I_o$	200 A
-------	-------

### DESCRIPTION

It extends the existing range of MT...KB bridges an extremely compact, encapsulated three phase bridge rectifiers offering efficient and reliable operation. They are intended for use in general purpose and heavy duty applications.

### MAJOR RATINGS AND CHARACTERISTICS

SYMBOL	CHARACTERISTICS	VALUES	UNITS
$I_o$		200	A
	$T_c$	85	°C
$I_{FSM}$	50 Hz	1800	A
	60 Hz	1880	
$I^2t$	50 Hz	16.2	kA <sup>2</sup> s
	60 Hz	14.7	
$I^2\sqrt{t}$		162	kA <sup>2</sup> √s
$V_{RRM}$		400	V
$T_{Stg}$	Range	- 40 to 150	°C
$T_J$			

### ELECTRICAL SPECIFICATIONS

#### VOLTAGE RATINGS

TYPE NUMBER	$V_{RRM}$ , MAXIMUM REPETITIVE PEAK REVERSE VOLTAGE V	$V_{RSM}$ , MAXIMUM NON-REPETITIVE PEAK REVERSE VOLTAGE V	$I_{RRM}$ MAXIMUM AT $T_J = 150\text{ °C}$ mA
200MT40KPbF	400	500	6

FORWARD CONDUCTION					
PARAMETER	SYMBOL	TEST CONDITIONS		VALUES	UNITS
Maximum RMS output current at case temperature	$I_O$	120° rect. conduction angle		200	A
				85	°C
Maximum peak, one-cycle forward, non-repetitive on state surge current	$I_{TSM}$	t = 10 ms	No voltage reapplied	1800	A
		t = 8.3 ms			
		t = 10 ms	100 % $V_{RRM}$ reapplied	1520	
		t = 8.3 ms		1590	
Maximum $I^2t$ for fusing	$I^2t$	t = 10 ms	No voltage reapplied	16.2	kA <sup>2</sup> s
		t = 8.3 ms			
		t = 10 ms	100 % $V_{RRM}$ reapplied	11.6	
		t = 8.3 ms		12.6	
Maximum $I^2\sqrt{t}$ for fusing	$I^2\sqrt{t}$	t = 0.1 to 10 ms, no voltage reapplied		162	kA <sup>2</sup> √s
Value of threshold voltage	$V_{F(TO)}$	$T_J$ maximum		0.76	V
Slope resistance	$r_t$			2.4	mΩ
Maximum forward voltage drop	$V_{FM}$	$I_{pk} = 200$ A, $T_J = 25$ °C, $t_p = 400$ μs single junction		1.40	V
Isolation voltage	$V_{ISOL}$	$T_J = 25$ °C all terminal shorted, f = 50 Hz, t = 1 s		4000	

THERMAL AND MECHANICAL SPECIFICATIONS					
PARAMETER	SYMBOL	TEST CONDITIONS		VALUES	UNITS
Maximum junction operating and storage temperature range	$T_J, T_{Stg}$			- 40 to 150	°C
Maximum thermal resistance, junction to case	$R_{thJC}$	DC operation per module		0.12	K/W
		DC operation per junction		0.69	
		120° rect. conduction angle per module		0.14	
		120° rect. conduction angle per junction		0.82	
Maximum thermal resistance, case to heatsink per module	$R_{thCS}$	Mounting surface smooth, flat and greased. Heatsink compound thermal conductivity = 0.42 W/mK		0.033	
Mounting torque ± 10 % to heatsink		A mounting compound is recommended and the torque should be rechecked after a period of 3 hours to allow for the spread of the compound. Lubricated threads.		4 to 6	Nm
Approximate weight				176	g

Three Phase Bridge  
(Power Module), 200 A

Vishay High Power Products

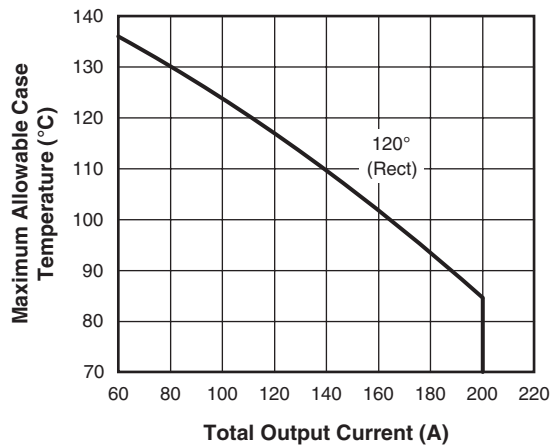

Fig. 1 - Current Rating Characteristics

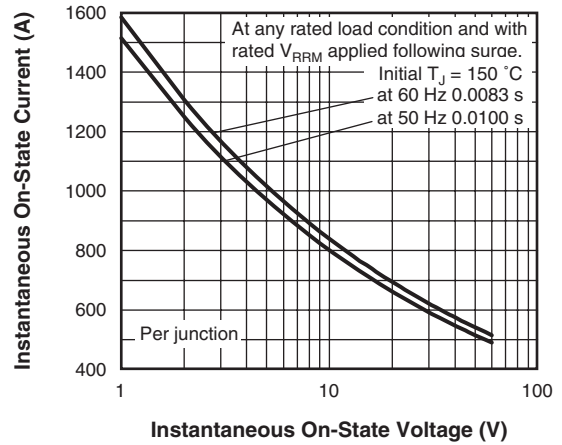

Fig. 3 - Maximum Non-Repetitive Surge Current

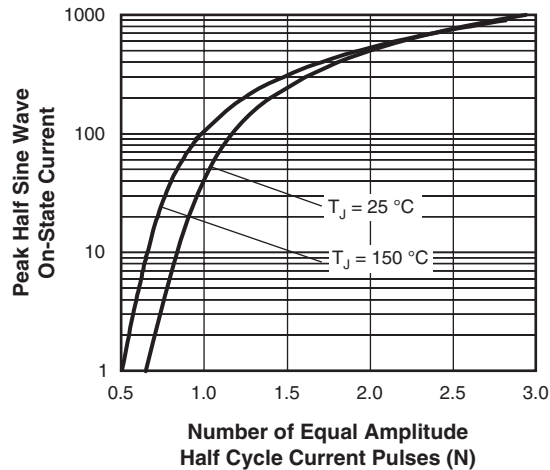

Fig. 2 - On-State Voltage Drop Characteristics

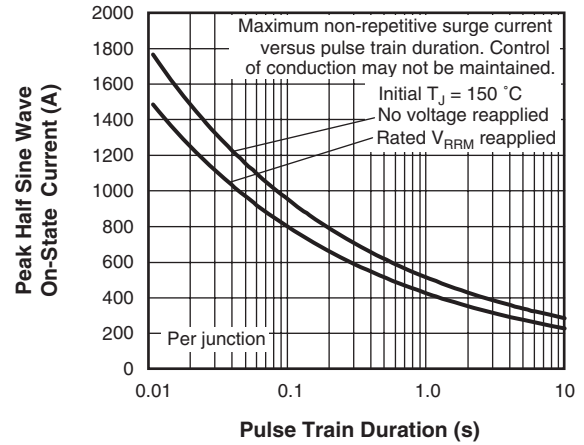

Fig. 4 - Maximum Non-Repetitive Surge Current

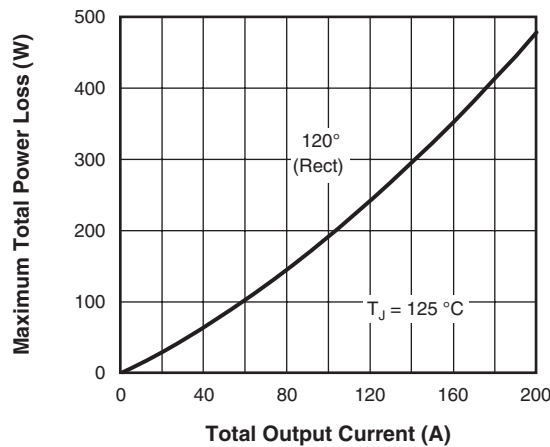
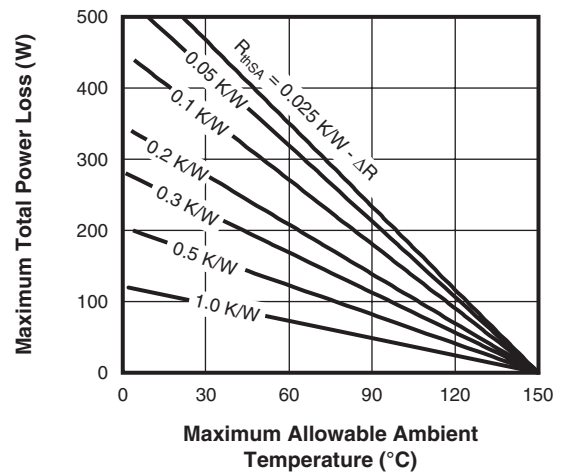

Fig. 5 - Current Rating Nomogram (1 Module Per Heatsink)



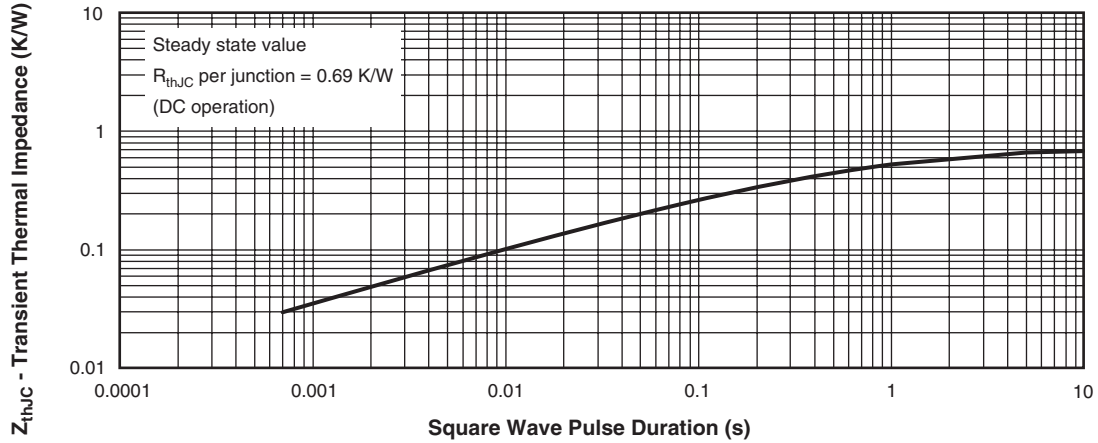

Fig. 6 - Thermal Impedance  $Z_{thJC}$  Characteristics

## ORDERING INFORMATION TABLE

Device code	<b>20</b>	<b>0</b>	<b>MT</b>	<b>40</b>	<b>K</b>	<b>PbF</b>
	①	②	③	④	⑤	
	<b>1</b>	-	Current rating code: 20 = 200 A (average)			
	<b>2</b>	-	Three phase diodes bridge			
	<b>3</b>	-	Essential part number			
	<b>4</b>	-	Voltage code x 10 = $V_{RRM}$ (40 = 400 V)			
	<b>5</b>	-	PbF = Lead (Pb)-free			

### Note

- To order the optional hardware go to [www.vishay.com/doc?95172](http://www.vishay.com/doc?95172)

## CIRCUIT CONFIGURATION

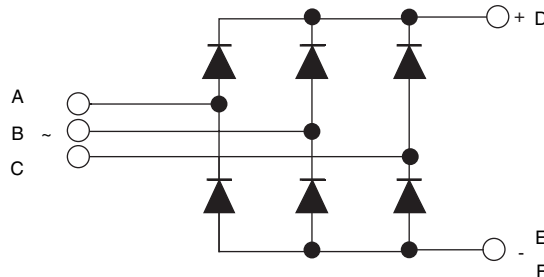

### LINKS TO RELATED DOCUMENTS

Dimensions

<http://www.vishay.com/doc?95004>

## MTK (with and without optional barrier)

### DIMENSIONS WITH OPTIONAL BARRIERS in millimeters (inches)

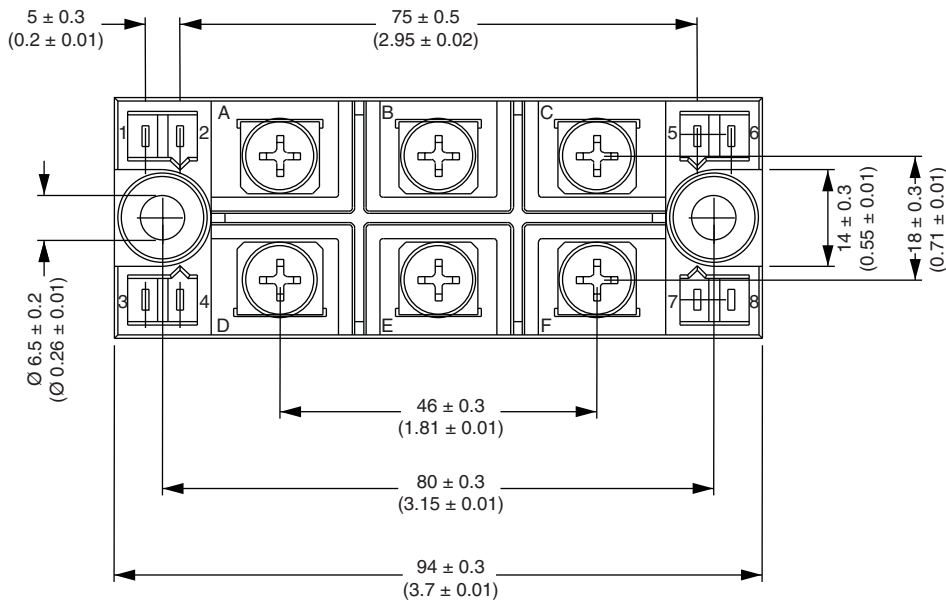
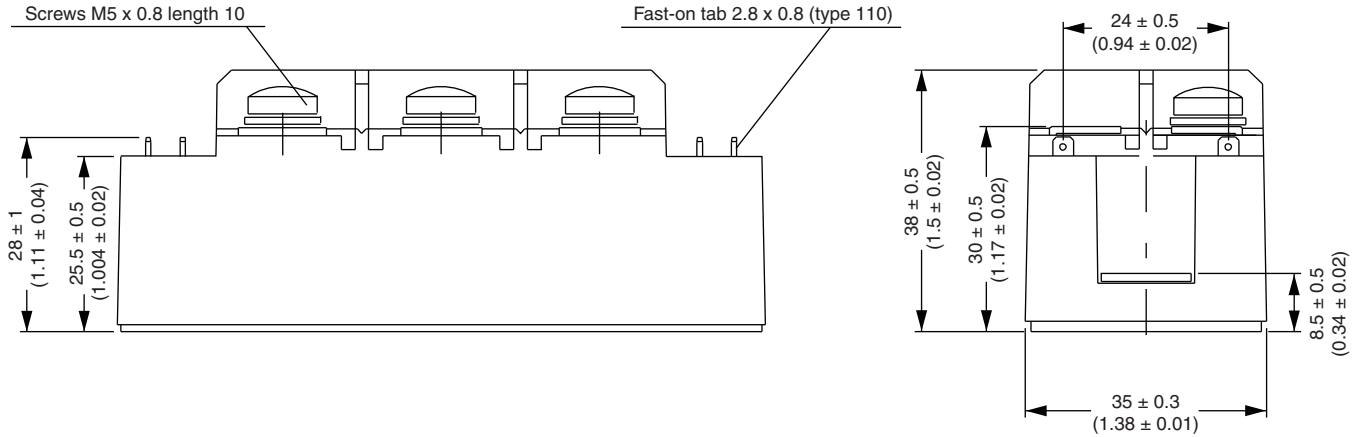

# Outline Dimensions

Vishay Semiconductors MTK (with and without optional barrier)



## DIMENSIONS WITHOUT OPTIONAL BARRIERS in millimeters (inches)

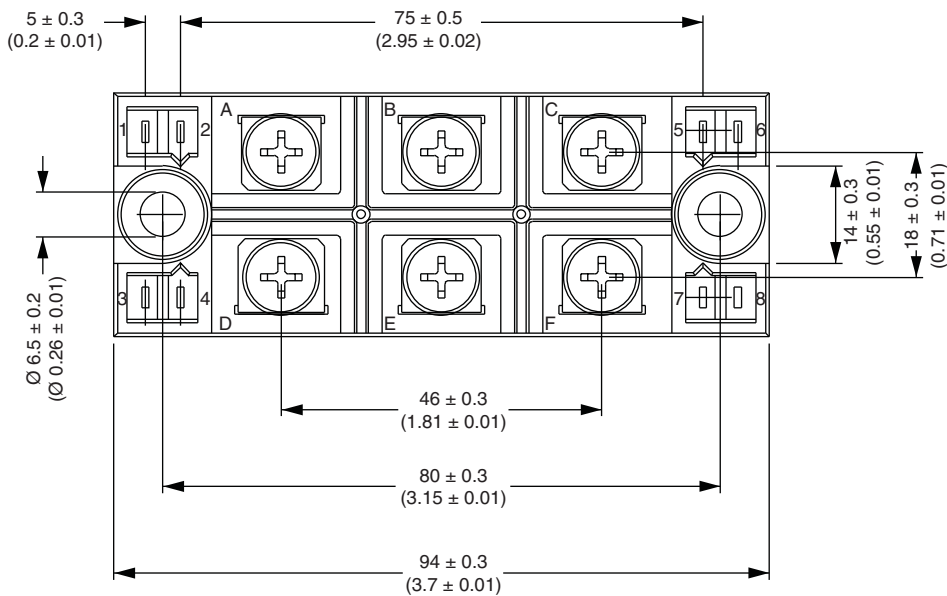
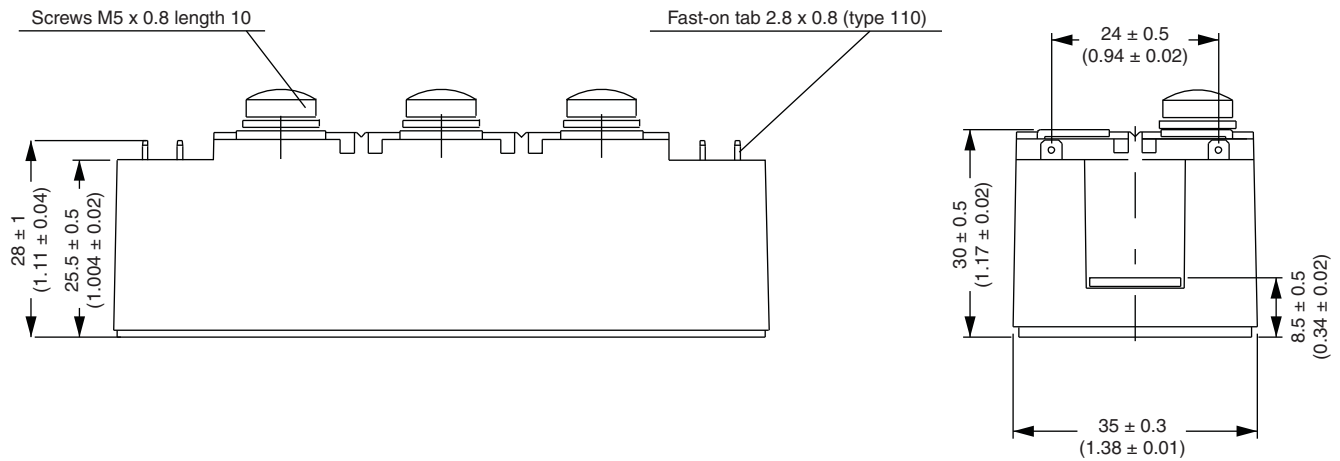



## Disclaimer

ALL PRODUCT, PRODUCT SPECIFICATIONS AND DATA ARE SUBJECT TO CHANGE WITHOUT NOTICE TO IMPROVE RELIABILITY, FUNCTION OR DESIGN OR OTHERWISE.

Vishay Intertechnology, Inc., its affiliates, agents, and employees, and all persons acting on its or their behalf (collectively, "Vishay"), disclaim any and all liability for any errors, inaccuracies or incompleteness contained in any datasheet or in any other disclosure relating to any product.

Vishay makes no warranty, representation or guarantee regarding the suitability of the products for any particular purpose or the continuing production of any product. To the maximum extent permitted by applicable law, Vishay disclaims (i) any and all liability arising out of the application or use of any product, (ii) any and all liability, including without limitation special, consequential or incidental damages, and (iii) any and all implied warranties, including warranties of fitness for particular purpose, non-infringement and merchantability.

Statements regarding the suitability of products for certain types of applications are based on Vishay's knowledge of typical requirements that are often placed on Vishay products in generic applications. Such statements are not binding statements about the suitability of products for a particular application. It is the customer's responsibility to validate that a particular product with the properties described in the product specification is suitable for use in a particular application. Parameters provided in datasheets and/or specifications may vary in different applications and performance may vary over time. All operating parameters, including typical parameters, must be validated for each customer application by the customer's technical experts. Product specifications do not expand or otherwise modify Vishay's terms and conditions of purchase, including but not limited to the warranty expressed therein.

Except as expressly indicated in writing, Vishay products are not designed for use in medical, life-saving, or life-sustaining applications or for any other application in which the failure of the Vishay product could result in personal injury or death. Customers using or selling Vishay products not expressly indicated for use in such applications do so at their own risk and agree to fully indemnify and hold Vishay and its distributors harmless from and against any and all claims, liabilities, expenses and damages arising or resulting in connection with such use or sale, including attorneys fees, even if such claim alleges that Vishay or its distributor was negligent regarding the design or manufacture of the part. Please contact authorized Vishay personnel to obtain written terms and conditions regarding products designed for such applications.

No license, express or implied, by estoppel or otherwise, to any intellectual property rights is granted by this document or by any conduct of Vishay. Product names and markings noted herein may be trademarks of their respective owners.

## Material Category Policy

**Vishay Intertechnology, Inc. hereby certifies that all its products that are identified as RoHS-Compliant fulfill the definitions and restrictions defined under Directive 2011/65/EU of The European Parliament and of the Council of June 8, 2011 on the restriction of the use of certain hazardous substances in electrical and electronic equipment (EEE) - recast, unless otherwise specified as non-compliant.**

**Please note that some Vishay documentation may still make reference to RoHS Directive 2002/95/EC. We confirm that all the products identified as being compliant to Directive 2002/95/EC conform to Directive 2011/65/EU.**