



# MICRF220

## 300MHz to 450MHz, 3.3V ASK/OOK Receiver with RSSI and Squelch

### General Description

The MICRF220 is a 300MHz to 450MHz super-heterodyne, image-reject, RF receiver with automatic gain control, ASK/OOK demodulator, analog RSSI output, and integrated squelch features. It only requires a crystal and a minimum number of external components to implement. The MICRF220 is ideal for low-cost, low-power, RKE, TPMS, and remote actuation applications.

The MICRF220 achieves  $-110\text{dBm}$  sensitivity at a bit rate of 1kbps with 0.1% BER. Four demodulator filter bandwidths are selectable in binary steps from 1625Hz to 13kHz at 433.92MHz, allowing the device to support bit rates up to 20kbps. The device operates from a supply voltage of 3.0V to 3.6V, and typically consumes 4.3mA of supply current at 315MHz and 6.0mA at 433.92MHz. A shutdown mode reduces supply current to  $0.1\mu\text{A}$  typical. The squelch feature decreases the activity on the data output pin until valid bits are detected while maintaining overall receiver sensitivity.

Data sheets and support documentation can be found on Micrel's web site at: [www.micrel.com](http://www.micrel.com).

### Features

- $-110\text{dBm}$  sensitivity at 1kbps with 0.1% BER
- Supports bit rates up to 20kbps at 433.92MHz
- 25dB image-reject mixer
- No IF filter required
- 60dB analog RSSI output range
- 3.0V to 3.6V supply voltage range
- 4.3mA supply current at 315MHz
- 6.0mA supply current at 434MHz
- $0.1\mu\text{A}$  supply current in shutdown mode
- Data output squelch until valid bits detected
- 16-pin QSOP package (4.9mm x 6.0mm)
- $-40^\circ\text{C}$  to  $+105^\circ\text{C}$  temperature range
- 3kV HBM ESD Rating

### Ordering Information

Part Number	Temperature Range	Package
MICRF220AYQS	$-40^\circ\text{C}$ to $+105^\circ\text{C}$	16-Pin QSOP

### Typical Application

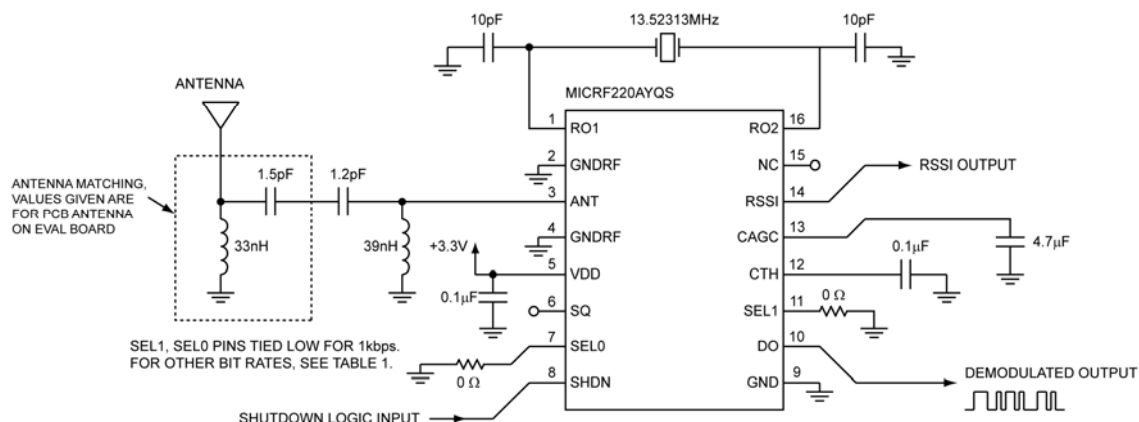

433.92MHz, 1kbps Operation

## Pin Configuration

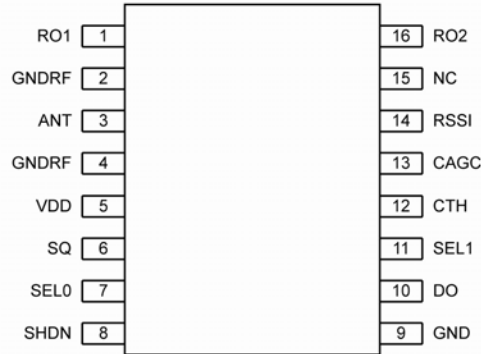

**MICRF220AYQS**

## Pin Description

Pin Number	Pin Name	Pin Function
1	RO1	Reference resonator connection to the Pierce oscillator. May also be driven by external reference signal of 200mVp-p to 1.5V p-p amplitude maximum. Internal capacitance of 7pF to GND during normal operation.
2	GNDRF	Ground connection for ANT RF input. Connect to PCB ground plane.
3	ANT	Antenna Input: RF Signal Input from Antenna. Internally AC coupled. It is recommended to use a matching network with an inductor-to-RF ground to improve ESD protection.
4	GNDRF	Ground connection for ANT RF input. Connect to PCB ground plane.
5	VDD	Positive supply connection for all chip functions. Bypass with 0.1 $\mu$ F capacitor located as close to the VDD pin as possible.
6	SQ	Squelch Control Logic-Level Input. An internal pull-up (5 $\mu$ A typical) pulls the logic-input HIGH when the device is enabled. A logic LOW on SQ squelches, or reduces, the random activity on DO pin when there is no RF input signal.
7	SEL0	Demodulator Filter Bandwidth Select Logic-Level Input. This pin has an internal pull-up (3 $\mu$ A typical) when the chip is on. Use in conjunction with SEL1 to control demodulation bandwidth.
8	SHDN	Shutdown Control Logic-Level Input. A logic-level LOW enables the device. A logic-level HIGH places the device in low-power shutdown mode. An internal pull-up (5 $\mu$ A typical) pulls the logic input HIGH.
9	GND	Ground connection for all chip functions except for RF input. Connect to PCB ground plane.
10	DO	Data Output. Demodulated data output. A current limited CMOS output during normal operation, 25k $\Omega$ pull-down is present when device is in shutdown.
11	SEL1	Demodulator Filter Bandwidth Select Logic-Level Input. This pin has an internal pull-up (3 $\mu$ A typical) when the chip is on. Use in conjunction with SEL0 to Demodulation bandwidth.
12	CTH	Demodulation Threshold Voltage Integration Capacitor. Connect a 0.1 $\mu$ F capacitor from CTH pin-to-GND to provide a stable slicing threshold.
13	CAGC	AGC Filter Capacitor. Connect a capacitor from this pin to GND. Refer to the <i>AGC Loop and CAGC</i> section for information on the capacitor value.
14	RSSI	Received Signal Strength Indicator. The voltage on this pin is an inversed amplified version of the voltage on CAGC. Output is from a switched capacitor integrating op amp with 250 $\Omega$ typical output impedance.
15	NC	No Connect. Leave this pin floating.
16	RO2	Reference resonator connection to the Pierce oscillator. Internal capacitance of 7pF to GND during normal operation.

**Absolute Maximum Ratings<sup>(1)</sup>**

Supply Voltage ( $V_{DD}$ )	+5V
ANT, SQ, SEL0, SEL1, SHDN DC Voltage	-0.3V to $V_{DD} + 0.3V$
Junction Temperature	+150°C
Lead Temperature (soldering, 10sec.)	+300°C
Storage Temperature	-65°C to +150°C
Maximum Receiver Input Power	+10dBm
ESD Rating <sup>(3)</sup>	3kV HBM

**Operating Ratings<sup>(2)</sup>**

Supply Voltage ( $V_{DD}$ )	+3.0V to +3.6V
Ambient Temperature ( $T_A$ )	-40°C to +105°C
ANT, SQ, SEL0, SEL1, SHDN DC Voltage	-0.3V to $V_{DD} + 0.3V$
Maximum Input RF Power	0 dBm
Receive Modulation Duty Cycle	20~80%
Frequency Range	300MHz to 450MHz

**Electrical Characteristics**

$V_{DD} = 3.3V$ ,  $V_{SHDN} = GND = 0V$ , SQ = open,  $C_{CAGC} = 4.7\mu F$ ,  $C_{CTH} = 0.1\mu F$ , unless otherwise noted. **Bold** values indicate  $-40^\circ C \leq T_A \leq 105^\circ C$ . "Bit rate" refers to the encoded bit rate throughout this datasheet (see Note 4).

Parameter	Condition	Min.	Typ.	Max.	Units
Operating Supply Current	Continuous Operation, $f_{RF} = 315MHz$		4.3		mA
	Continuous Operation, $f_{RF} = 433.92MHz$		6.0		
Shutdown Current	$V_{SHDN} = V_{DD}$		0.1		$\mu A$
<b>Receiver</b>					
Conducted Receiver Sensitivity@1kbps (Note 5)	433.92MHz, $V_{SEL1} = V_{SEL0} = 0V$ , BER = 1%		-112.5		dBm
	433.92MHz, $V_{SEL1} = V_{SEL0} = 0V$ , BER = 0.1%		-110		
	315MHz, $V_{SEL1} = 0V$ , $V_{SEL0} = 3.3V$ , BER = 1%		-112.5		
	315MHz, $V_{SEL1} = 0V$ , $V_{SEL0} = 3.3V$ , BER = 0.1%		-110		
Image Rejection	$f_{IMAGE} = f_{RF} - 2f_{IF}$		25		dB
IF Center Frequency ( $f_{IF}$ )	$f_{RF} = 315MHz$		0.85		MHz
	$f_{RF} = 433.92MHz$		1.18		
-3dB IF Bandwidth	$f_{RF} = 315MHz$		235		kHz
	$f_{RF} = 433.92MHz$		330		
CAGC Voltage Range	-40dBm RF input level		1.15		V
	-100dBm RF input level		1.55		
<b>Reference Oscillator</b>					
Reference Oscillator Frequency	$f_{RF} = 315 MHz$		9.81713		MHz
	$f_{RF} = 433.92 MHz$		13.52313		
Reference Buffer Input Impedance	RO1 when driven externally		1.6		k $\Omega$
Reference Oscillator Bias Voltage	RO2		1.15		V
Reference Oscillator Input Range	External input, AC couple to RO1	0.2		1.5	$V_{P-P}$
Reference Oscillator Source Current	$V_{RO1} = 0V$		300		$\mu A$

## Electrical Characteristics (Continued)

Parameter	Condition	Min.	Typ.	Max.	Units
<b>Demodulator</b>					
CTH Source Impedance, Note 6	$f_{REF} = 9.81713\text{MHz}$		165		k $\Omega$
	$f_{REF} = 13.52313\text{MHz}$		120		
CTH Leakage Current In CTH Hold Mode	$T_A = +25^\circ\text{C}$		1		nA
	$T_A = +105^\circ\text{C}$		10		
<b>Digital / Control Functions</b>					
DO Pin Output Current	As output source @ $0.8 V_{DD}$ As output sink @ $0.2 V_{DD}$		300 680		$\mu\text{A}$
Output Rise Time	15pF load on DO pin, transition time between $0.1xV_{DD}$ and $0.9xV_{DD}$		600		ns
Output Fall Time			200		
Input High Voltage	SHDN, SEL0, SEL1, SQ	$0.8V_{DD}$			V
Input Low Voltage	SHDN, SEL0, SEL1, SQ			$0.2V_{DD}$	V
Output Voltage High	DO	$0.8V_{DD}$			V
Output Voltage Low	DO			$0.2V_{DD}$	V
<b>RSSI</b>					
RSSI DC Output Voltage Range	$-110\text{dBm}$ RF input level		0.5		V
	$-50\text{dBm}$ RF input level		2.0		
RSSI Output Current	$5\text{k}\Omega$ load to GND, $-50\text{dBm}$ RF input level		400		$\mu\text{A}$
RSSI Output Impedance			250		$\Omega$
RSSI Response Time	$V_{SEL0} = V_{SEL1} = 0\text{V}$ , RF input power stepped from no input to $-50\text{dBm}$		10		ms

### Notes:

- Exceeding the absolute maximum rating may damage the device.
- The device is not guaranteed to function outside of its operating rating.
- Device is ESD sensitive. Use appropriate ESD precautions. Exceeding the absolute maximum rating may damage the device.
- Encoded bit rate is  $1/(\text{shortest pulse duration})$  that appears at MICRF220 DO pin.

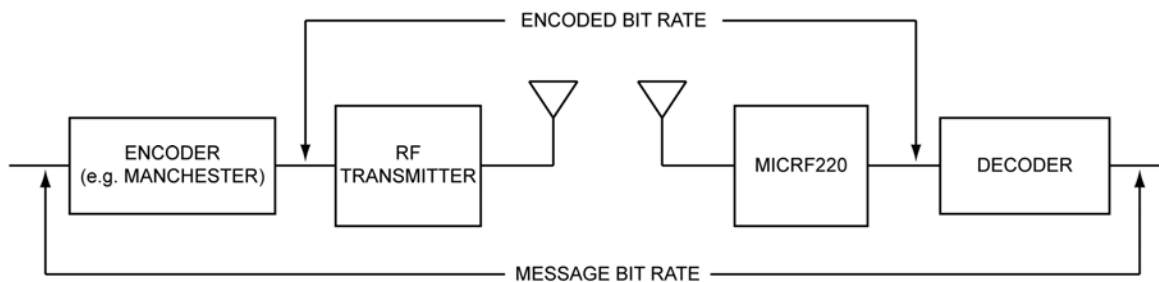

- In an ON/OFF keyed (OOK) signal, the signal level goes between a "mark" level (when the RF signal is ON) and a "space" level (when the RF signal is OFF). Sensitivity is defined as the input signal level when "ON" necessary to achieve a specified BER (bit error rate). BER measured with the built-in BERT function in Agilent E4432B using the PN9 sequence. Sensitivity measurement values are obtained using an input matching network corresponding to 315MHz or 433.92MHz.
- CTH source impedance is inversely proportional to the reference frequency. In production testing, the typical source impedance value is verified with 12MHz reference frequency.

# Typical Characteristics

$V_{DD} = 3.3V$ ,  $T_A = +25^\circ C$ , BER measured with PN9 sequence, unless otherwise noted.

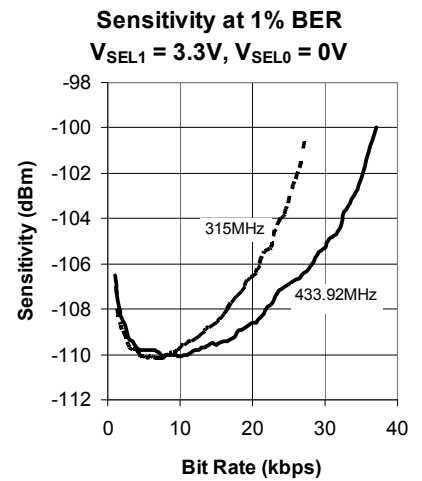
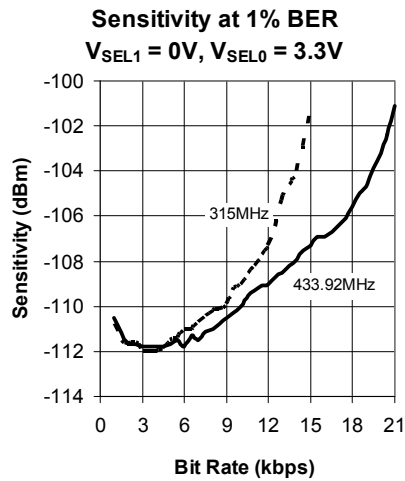
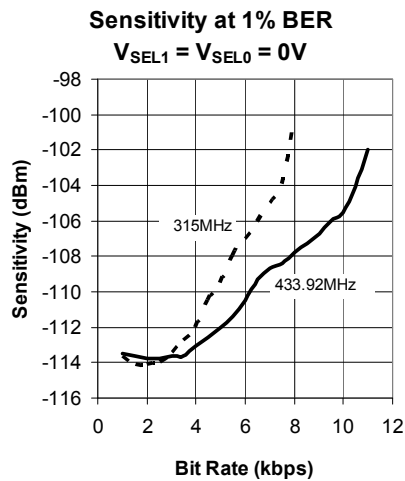
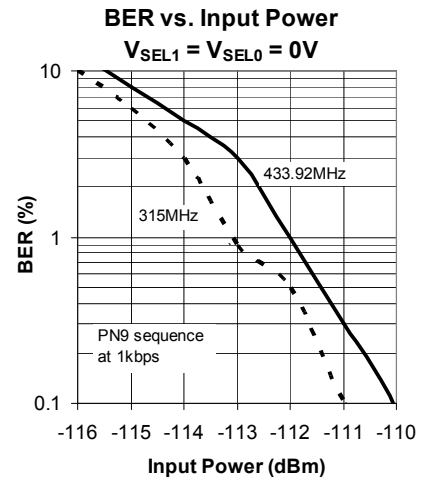
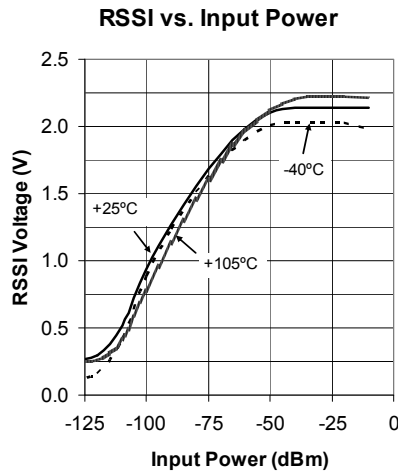
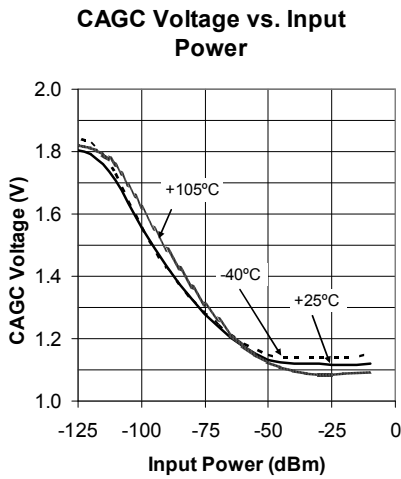
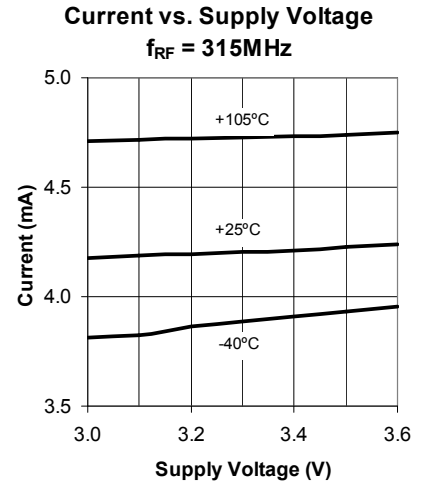
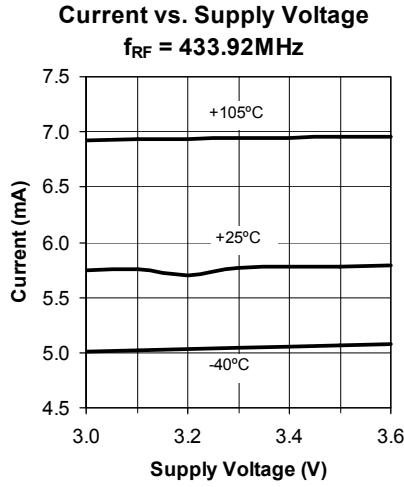
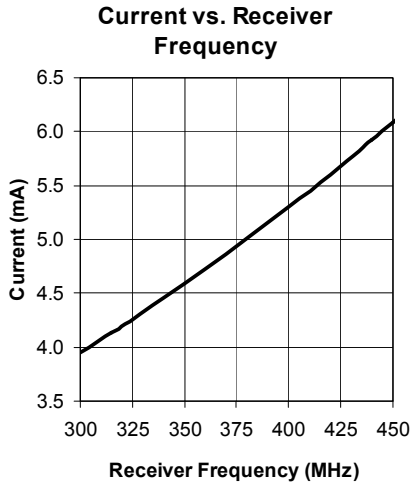

## Typical Characteristics (Continued)

$V_{DD} = 3.3V$ ,  $T_A = +25^\circ C$ , BER measured with PN9 sequence, unless otherwise noted.

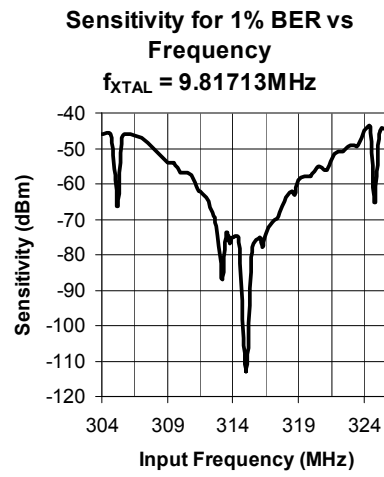
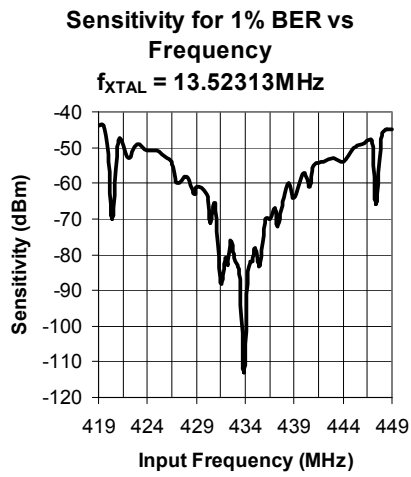
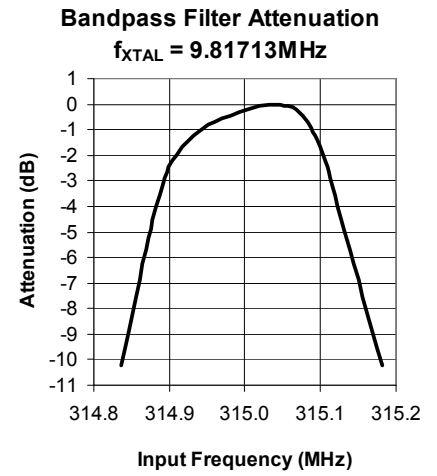
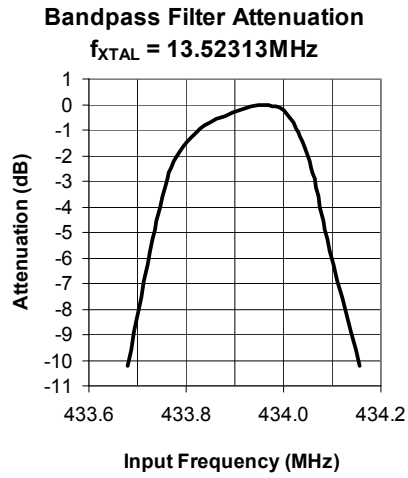
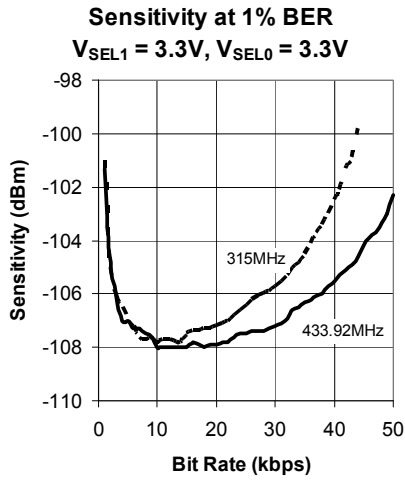

# Functional Diagram

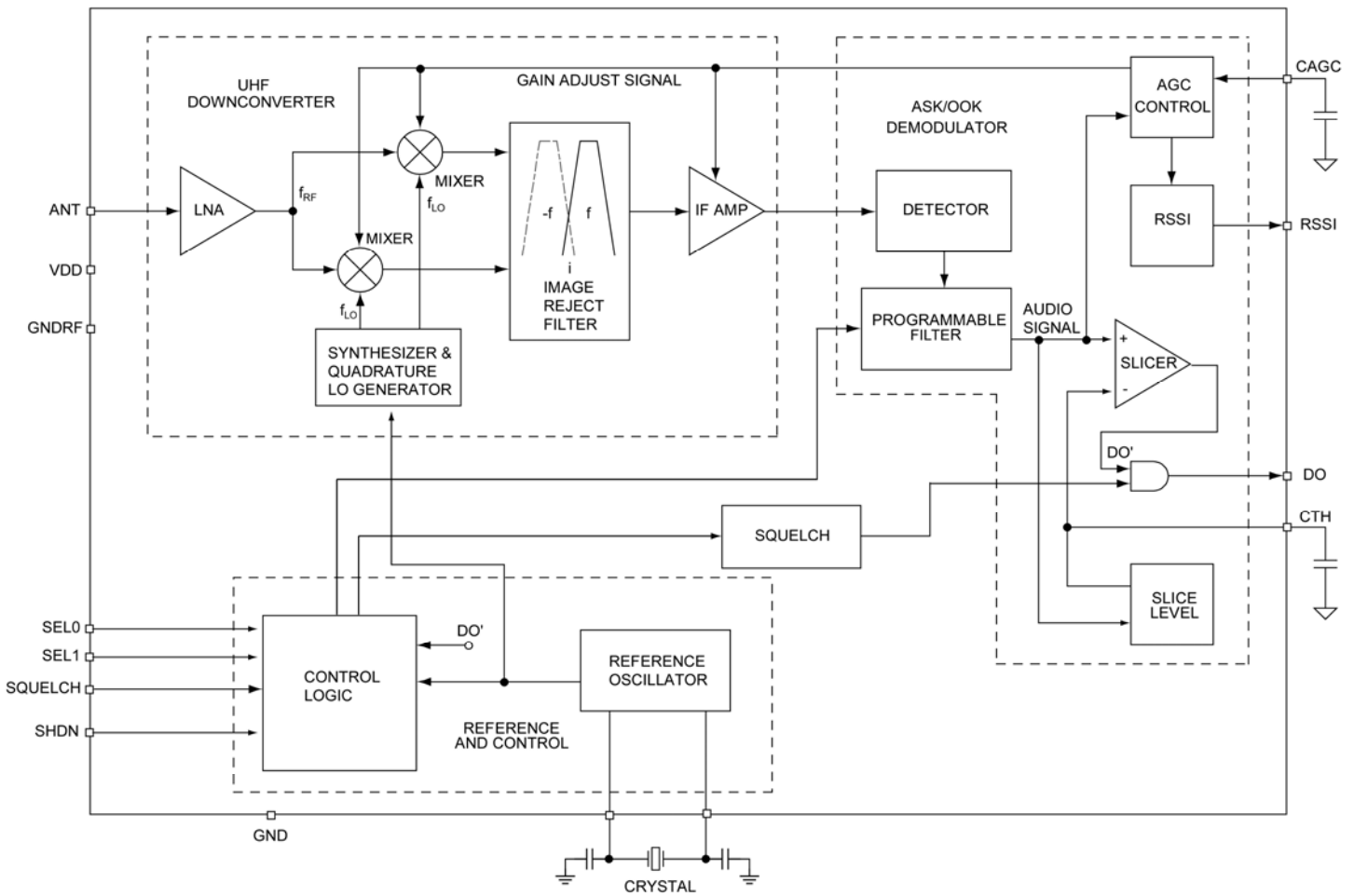

Figure 1. Simplified Block Diagram

## Functional Description

The simplified block diagram (Figure 1) illustrates the basic structure of the MICRF220 receiver. It is made up of four sub-blocks:

- UHF Down-Converter
- ASK/OOK Demodulator
- Reference and Control logic
- Squelch Control

Outside the device, the MICRF220 receiver requires just a few components to operate: a capacitor from CAGC to GND, a capacitor from CTH-to-GND, a reference crystal resonator with associated loading capacitors, LNA input matching components, and a power-supply decoupling capacitor.

## Receiver Operation

### UHF Downconverter

The UHF down-converter has six sub-blocks: LNA, mixers, synthesizer, image reject filter, band pass filter and IF amplifier.

### LNA

The RF input signal is AC-coupled into the gate of the LNA input device. The LNA configuration is a cascaded common source NMOS amplifier. The amplified RF signal is then fed to the RF ports of two double balanced mixers.

### Mixers and Synthesizer

The LO ports of the mixers are driven by quadrature local oscillator outputs from the synthesizer block. The local oscillator signal from the synthesizer is placed on the low side of the desired RF signal (Figure 2). The product of the incoming RF signal and local oscillator signal will yield the IF frequency, which will be demodulated by the detector of the device. The image reject mixer suppresses the image frequency which is below the wanted signal by two times the IF frequency. The local oscillator frequency ( $f_{LO}$ ) is set to 32 times the crystal reference frequency ( $f_{REF}$ ) via a phase-locked loop synthesizer with a fully-integrated loop filter:

$$f_{LO} = 32 \times f_{REF} \tag{Eq. 1}$$

MICRF220 uses an IF frequency scheme that scales the IF frequency ( $f_{IF}$ ) with  $f_{REF}$  according to:

$$f_{IF} = f_{REF} \times \frac{87}{1000} \tag{Eq. 2}$$

Therefore, the reference frequency  $f_{REF}$  needed for a given desired RF frequency ( $f_{RF}$ ) is approximately:

$$f_{REF} = f_{RF} / \left( 32 + \frac{87}{1000} \right) \tag{Eq. 3}$$

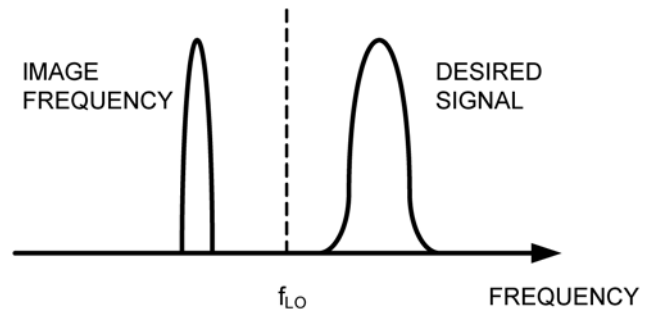

Figure 2. Low-Side Injection Local Oscillator

### Image-Reject Filter and Band-Pass Filter

The IF ports of the mixer produce quadrature-down converted IF signals. These IF signals are low-pass filtered to remove higher-frequency products prior to the image reject filter where they are combined to reject the image frequency. The IF signal then passes through a third order band pass filter. The IF bandwidth is 330kHz @ 433.92MHz, and will scale with RF operating frequency according to:

$$BW_{IF} = BW_{IF@433.92 \text{ MHz}} \times \left( \frac{\text{Operating Freq (MHz)}}{433.92} \right) \tag{Eq. 4}$$

These filters are fully integrated inside the MICRF220. After filtering, four active gain controlled amplifier stages enhance the IF signal to its proper level for demodulation.

### ASK/OOK Demodulator

The demodulator section is comprised of detector, programmable low pass filter, slicer, and AGC comparator.



### Detector and Programmable Low-Pass Filter

The demodulation starts with the detector removing the carrier from the IF signal. Post detection, the signal becomes baseband information. The low-pass filter further enhances the baseband signal. There are four selectable low-pass filter BW settings; 1625Hz, 3250Hz, 6500Hz, and 13000Hz for 433.92MHz operation. The low-pass filter BW is directly proportional to the crystal reference frequency, and hence RF Operating Frequency. Filter BW values can be easily calculated by direct scaling. Equation 5 illustrates filter Demod BW calculation:

$$BW_{\text{Operating Freq}} = BW_{@433.92\text{MHz}} \times \left( \frac{\text{Operating Freq (MHz)}}{433.92} \right) \quad \text{Eq. 5}$$

It is very important to choose the baseband bandwidth setting suitable for the data rate to minimize bit error rate. Use the operating curves that show BER vs. bit rates for different SEL1, SEL0 settings as a guide.

This low-pass filter -3dB corner, or the demodulation BW, is set at 13000Hz @ 433.92MHz as default (assuming both SEL0 and SEL1 pins are floating, internal pull-up resistors set the voltage to  $V_{DD}$ ). The low-pass filter can be hardware set by external pins SEL0 and SEL1. Table 2 demonstrates the scaling for 315MHz RF frequency:

$V_{SEL1}$	$V_{SEL0}$	Low-Pass Filter BW	Maximum Encoded Bit Rate
GND	GND	1625Hz	2.5kbps
GND	$V_{DD}$	3250Hz	5kbps
$V_{DD}$	GND	6500Hz	10kbps
$V_{DD}$	$V_{DD}$	13000Hz	20kbps

**Table 1. Low-Pass Filter Selection @ 434MHz RF Input**

$V_{SEL1}$	$V_{SEL0}$	Low-Pass Filter BW	Maximum Encoded Bit Rate
GND	GND	1170Hz	1.8kbps
GND	$V_{DD}$	2350Hz	3.6kbps
$V_{DD}$	GND	4700Hz	7.2kbps
$V_{DD}$	$V_{DD}$	9400Hz	14.4kbps

**Table 2. Low-Pass Filter Selection @ 315MHz RF Input**

### Slicer and CTH

The signal prior to the slicer, labeled “Audio Signal” in Figure 1, is still baseband analog signal. The data slicer converts the analog signal into ones and zeros based upon 50% of the slicing threshold voltage built up in the CTH capacitor. After the slicer, the signal is demodulated OOK digital data. When there is only thermal noise at ANT pin, the voltage level on CTH pin is about 650mV. This voltage starts to drop when there is RF signal present. When the RF signal level is greater than -100dBm, the voltage is about 400mV.

The value of the capacitor from CTH pin to GND is not critical to the sensitivity of MICRF220, although it should be large enough to provide a stable slicing level for the comparator. The value used in the evaluation board of 0.1µF is good for all bit rates from 500bps to 20kbps.

### CTH Hold Mode

If the internal demodulated signal (DO' in Figure 1) is at logic LOW for more than about 4msec, the chip automatically enters CTH hold mode, which holds the voltage on CTH pin constant even without RF input signal. This is useful in a transmission gap, or “deadtime”, used in many encoding schemes. When the signal reappears, CTH voltage does not need to re-settle, improving the time to output with no pulse width distortion, or time to good data (TTGD).

### AGC Loop and CAGC

The AGC comparator monitors the signal amplitude from the output of the programmable low-pass filter. The AGC loop in the chip regulates the signal at this point to be at a constant level when the input RF signal is within the AGC loop dynamic range (about -115dBm to -40dBm).

When the chip first turns on, the fast charge feature charges the CAGC node up with 120µA typical current. When the voltage on CAGC increases, the gains of the mixer and IF amplifier go up, increasing the amplitude of the audio signal (as labeled in Figure 1), even with only thermal noise at the LNA input. The fast-charge current is disabled when the audio signal crosses the slicing threshold, causing DO' to go high, for the first time.

When an RF signal is applied, a fast attack period ensues, when 600µA current discharges the CAGC node to reduce the gain to a proper level. Once the loop reaches equilibrium, the fast attack current is disabled, leaving only 15µA to discharge CAGC or 1.5µA to charge CAGC. The fast attack current is enabled only when the RF signal increases faster than the ability of the AGC loop to track it.

The value of CAGC impacts the time to good data (TTGD), which is defined as the time when signal is first applied, to when the pulse width at DO is within 10% of the steady state value. The optimal value of CAGC depends upon the setting of the SEL0 and SEL1 pins. A smaller CAGC value does NOT always result in a shorter TTGD. This is due to the loop dynamics, the fast discharge current being 600 $\mu$ A, and the charge current being only 1.5 $\mu$ A. For example, if  $V_{SEL0} = V_{SEL1} = 0V$ , the low pass filter bandwidth is set to a minimum and CAGC capacitance is too small, TTGD will be longer than if CAGC capacitance is properly chosen. This is because when RF signal first appears, the fast discharge period will reduce  $V_{CAGC}$  very fast, lowering the gain of the mixer and IF amplifier. But since the low pass filter bandwidth is low, it takes too long for the AGC comparator to see a reduced level of the audio signal, so it can not stop the discharge current. This causes an undershoot in CAGC voltage and a corresponding overshoot in RSSI voltage. Once CAGC undershoots, it takes a long time for it to charge back up because the current available is only 1.5 $\mu$ A.

Table 3 lists the recommended CAGC values for different SEL0 and SEL1 settings.

$V_{SEL1}$	$V_{SEL0}$	CAGC value
0V	0V	4.7 $\mu$ F
0V	$V_{DD}$	2.2 $\mu$ F
$V_{DD}$	0V	1 $\mu$ F
$V_{DD}$	$V_{DD}$	0.47 $\mu$ F

**Table 3. Minimum Suggested CAGC Values**

Figure 3 illustrates what occurs if CAGC capacitance is too small for a given SEL1, SEL0 setting. Here,  $V_{SEL1} = 0V$ ,  $V_{SEL0} = V_{DD}$ , the capacitance on CAGC pin is 0.47 $\mu$ F, and the RF input level is stepped from no signal to -100dBm. RSSI voltage is shown instead of CAGC voltage because RSSI is a buffered version of CAGC (with an inversion and amplification). Probing CAGC directly can affect the loop dynamics through resistive loading from a scope probe, especially in the state where only 1.5 $\mu$ A is available, whereas probing RSSI does not. When RF signal is first applied, RSSI voltage overshoots due to the fast discharge current on CAGC, and the loop is too slow to stop this fast discharge current in time. Since the voltage on CAGC is too low, the audio signal level is lower than the slicing threshold (voltage on CTH), and DO pin is low. Once the fast discharge current stops, only the small 1.5 $\mu$ A charge current is available in settling the AGC loop to the correct level, causing the recovery from CAGC undershoot/RSSI overshoot condition to be slow. As a result, TTGD is about 9.1ms.

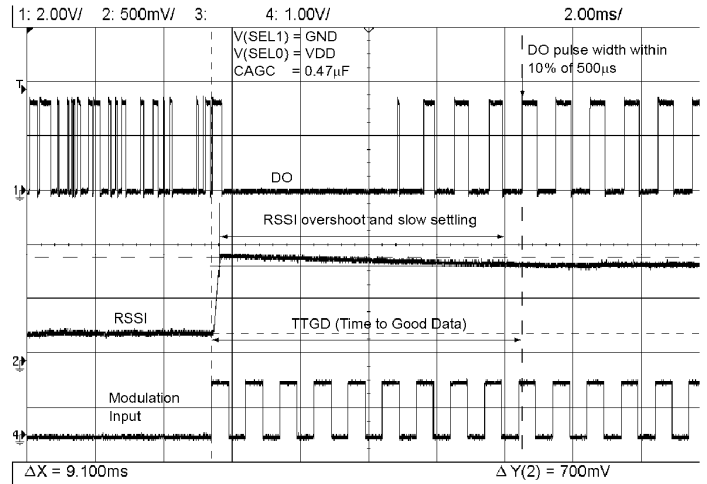

**Figure 3. RSSI Overshoot and Slow TTGD (9.1ms)**

Figure 4 shows the behavior with a larger capacitor on CAGC pin (2.2 $\mu$ F),  $V_{SEL1} = 0V$ , and  $V_{SEL0} = V_{DD}$ . In this case,  $V_{CAGC}$  does not undershoot (RSSI does not overshoot), and TTGD is relatively short at 1ms.

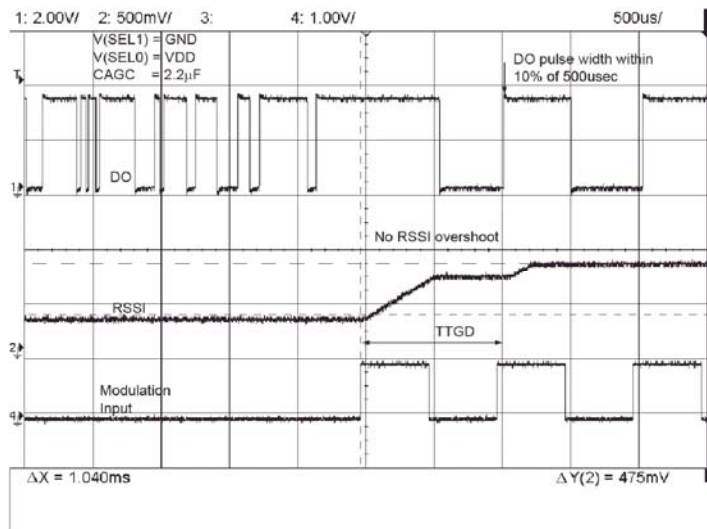

**Figure 4. Proper TTGD (1ms) with Sufficient CAGC**

**Reference Oscillator**

The reference oscillator in the MICRF220 (Figure 5) uses a basic Pierce crystal oscillator configuration with MOS transistor to provide negative resistance. Though the MICRF220 has built-in load capacitors for the crystal oscillator, the external load capacitors are still required for tuning it to the right frequency. RO1 and RO2 are external pins of the MICRF220 to connect the crystal to the reference oscillator.

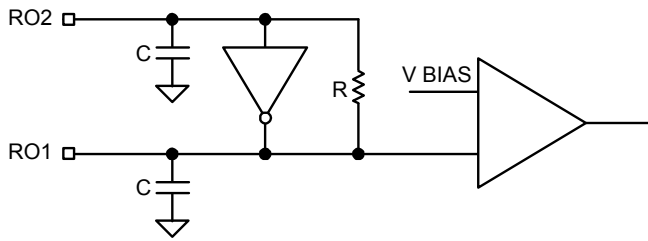

Figure 5. Reference Oscillator Circuit

Reference oscillator crystal frequency can be calculated according to Equation 3. For example, if  $f_{RF} = 433.92\text{MHz}$ ,  $f_{REF} = 13.52313\text{MHz}$ . Table 4 lists the values of reference frequencies at different popular RF frequencies. To operate the MICRF220 with minimum offset, use proper loading capacitance recommended by the crystal manufacturer.

RF Input Frequency (MHz)	Reference Frequency (MHz)
315.0	9.81713*
390.0	12.15446
418.0	13.02708
433.92	13.52313*

\*Empirically derived, slightly different from Equation 3.

Table 4. Reference Frequency Examples

**Squelch Operation**

When squelch function is enabled by tying the SQ pin low, the chip will monitor incoming pulse width before allowing activity on DO pin. The pulse width is set by SEL1 and SEL0 pins as shown in Table 5, and is inversely proportional to frequency. When there is no input signal and squelch is not enabled (SQ pin left floating), voltage on DO chatters due to random noise as shown in Figure 6. If SQ pin is tied low, the activity on DO pin is much reduced as shown in Figure 7.

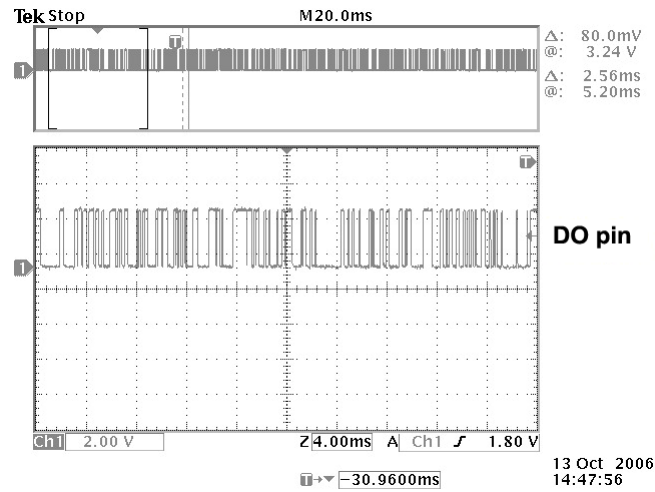

Figure 6. Data Out Pin with No Squelch ( $V_{SQ} = V_{DD}$ )

When squelch function is enabled by tying the SQ pin low, the chip will monitor incoming pulse width before allowing activity on DO pin. The pulse width is set by SEL1 and SEL0 pins as shown in Table 5, and is inversely proportional to frequency. When there is no input signal and squelch is not enabled (SQ pin left floating), voltage on DO chatters due to random noise as shown in Figure 6. If SQ pin is tied low, the activity on DO pin is much reduced as shown in Figure 7.

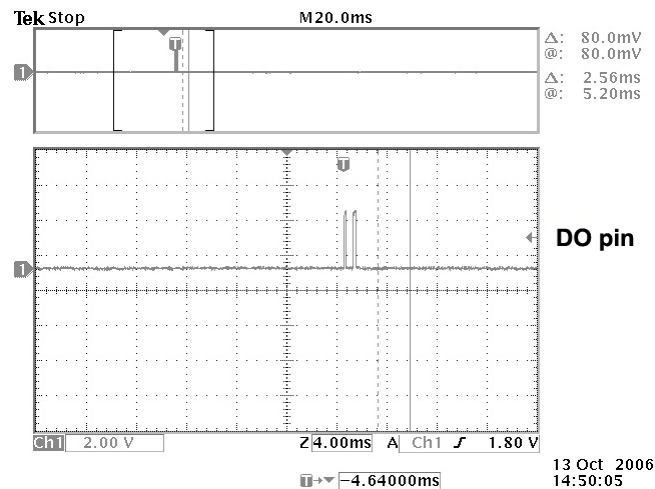

Figure 7. Data Out Pin with Squelch ( $V_{SQ} = 0V$ )

When four or less out of eight pulses (at DO'signal labeled in Figure 1) are good, the DO output is squelched. If good pulse count increases to seven or more in any eight sequential pulses, squelch is disabled, thereby allowing data to output at DO pin. A good pulse has a duration that is greater than the values listed in Table 5, and it can be a high or a low pulse. For other frequencies pulse times are calculated as follows:

$$PW = PW_{@433.92 \text{ MHz}} \times \left( \frac{433.92}{\text{Operating Freq(MHz)}} \right) \quad \text{Eq. 6}$$

V <sub>SEL1</sub>	V <sub>SEL0</sub>	Pulse Width at 315MHz (μs)	Pulse Width at 433.92MHz (μs)
0V	0V	420	305
0V	V <sub>DD</sub>	210	152
V <sub>DD</sub>	0V	105	76
V <sub>DD</sub>	V <sub>DD</sub>	53	38

**Table 5. Pulse Width Settings in Squelch**

# Application Information

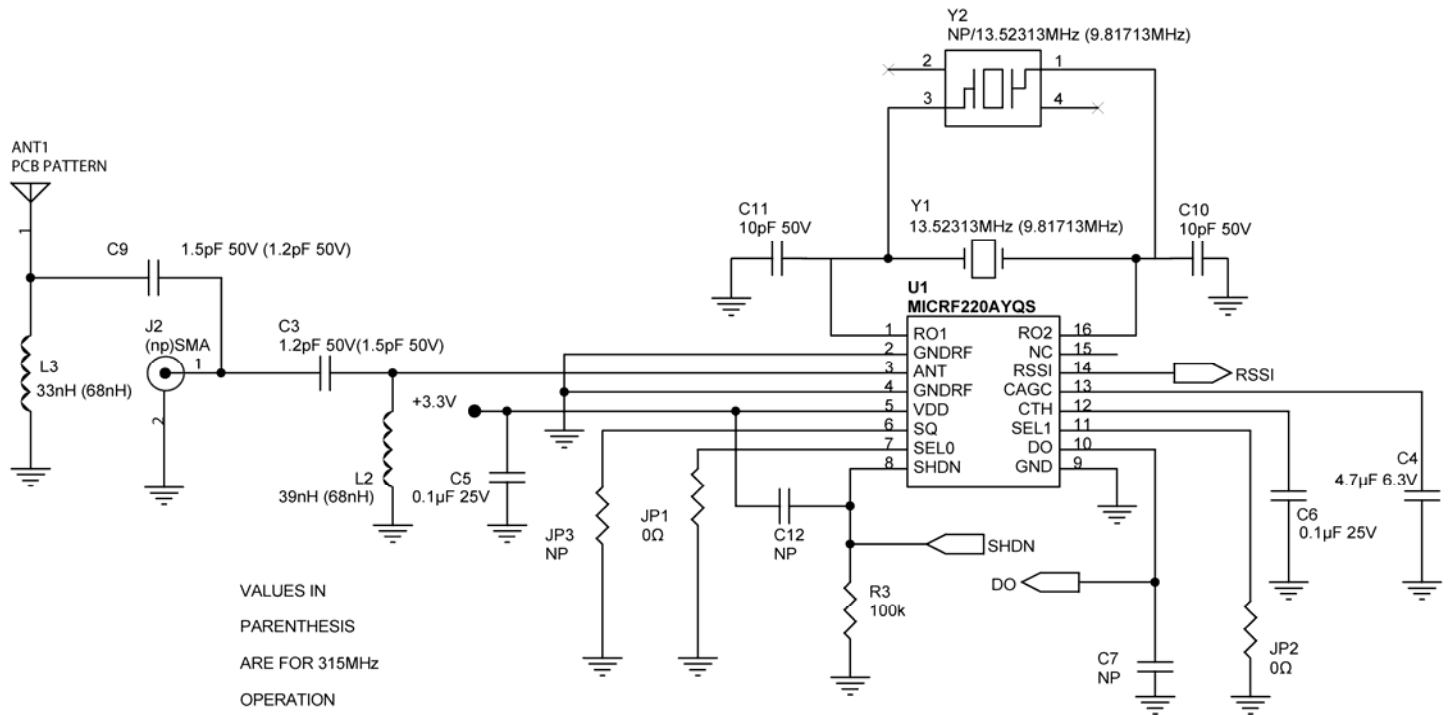

Figure 8. MICRF220 EV Board Application Example

### Supply Voltage Ramping

When supply voltage is initially applied, it should rise monotonically from 0V to 3.3V to ensure proper startup of the crystal oscillator and the PLL. It should not have multiple bounces across 2.6V, which is the threshold of the undervoltage lockout (UVLO) circuit inside MICRF220.

### Antenna and RF Port Connections

Figure 8 shows the schematic of the MICRF220 Evaluation Board. Figures 9 thru 11 depict PCB images. This evaluation board is a good starting point for the prototyping of most applications. The evaluation board offers two options of injecting the RF input signal: through a PCB antenna or through a 50Ω SMA connector. The SMA connection allows for conductive testing, or an external antenna.

### Low-Noise Amplifier Input Matching

Capacitor C3 and inductor L2 form the “L” shape input matching network to the SMA connector. The capacitor cancels out the inductive portion of the net impedance after the shunt inductor, and provides additional attenuation for low-frequency outside band noise. The inductor is chosen to over resonate the net capacitance at the pin, leaving a net-positive reactance and increasing the real part of the impedance. It also provides additional ESD protection for the antenna pin. The input impedance of the device is listed in Table 6 to aid calculation of matching values. Note that the net impedance at the pin is easily affected by component pads parasitic due to the high input impedance of the device. The numbers in Table 6 does NOT include trace and component pad parasitic capacitance, which total about 0.75pF on the evaluation board.

The matching components to the PCB antenna (L3 and C9) were empirically derived for best over-the-air reception range.

Frequency (MHz)	Z Device (Ω)
315	23 – j290
390	14 – j230
418	17 – j216
433.92	12 – j209

**Table 6. Input Impedance for the Most Used Frequencies**

### Crystal Selection

The crystal resonator provides a reference clock for all the device internal circuits. Crystal tolerance needs to be chosen such that the down-converted signal is always inside the IF bandwidth of MICRF220. From this consideration, the tolerance should be ±50ppm on both the transmitter and the MICRF220 side. ESR should be less than 300Ω, and the temperature range of the crystal should match the range required by the application. With the Abracon crystal listed in the Bill of Materials, a typical MICRF220 crystal oscillator still starts up at 105°C with additional 400Ω series resistance.

The oscillator of the MICRF220 is a Pierce-type oscillator. Good care must be taken when laying out the printed circuit board. Avoid long traces and place the ground plane on the top layer close to the REFOSC pins RO1 and RO2. When care is not taken in the layout, and the crystals used are not verified, the oscillator may not start or takes longer to start. Time-to-good-data will be longer as well.

### PCB Considerations and Layout

Figures 9 thru 11 illustrate the MICRF220 Evaluation Board layout. The Gerber files provided are downloadable from the Micrel website and contain the remaining layers needed to fabricate this board. When copying or making one's own boards, make the traces as short as possible. Long traces alter the matching network and the values suggested are no longer valid. Suggested matching values may vary due to PCB variations. A PCB trace 100 mils (2.5mm) long has about 1.1nH inductance. Optimization should always be done with exhaustive range tests. Make sure the individual ground connection has a dedicated via rather than sharing a few of ground points by a single via. Sharing ground via will increase the ground path inductance. Ground plane should be solid and with no sudden interruptions. Avoid using ground plane on top layer next to the matching elements. It normally adds additional stray capacitance which changes the matching. Do not use Phenolic materials as they are conductive above 200MHz. Typically, FR4 or better materials are recommended. The RF path should be as straight as possible to avoid loops and unnecessary turns. Separate ground and V<sub>DD</sub> lines from other digital or switching power circuits (such microcontroller...etc). Known sources of noise should be laid out as far as possible from the RF circuits. Avoid unnecessary wide traces which would add more distribution capacitance (between top trace to bottom GND plane) and alter the RF parameters.

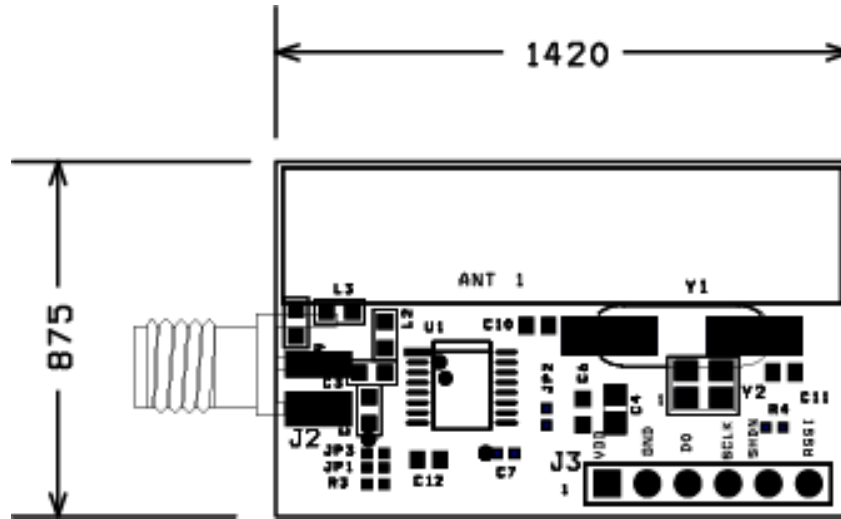

Figure 9. MICRF220 EV Board Assembly

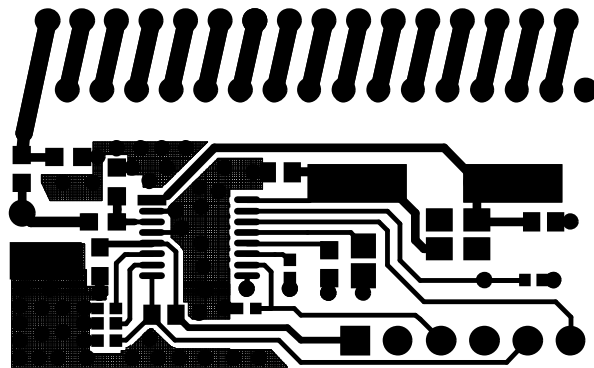

Figure 10. MICRF220 EV Board Top Layer

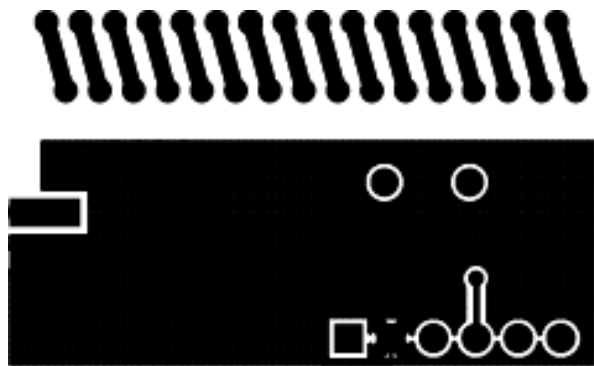

Figure 11. MICRF220 EV Board Bottom Layer

**MICRF220 Evaluation Board (433.92MHz) Bill of Materials**

Item	Part Number	Manufacturer	Description
C3	GRM1885C1H1R2CZ01	Murata <sup>(1)</sup>	1.2pF 100V, $\pm 0.25\text{pF}$ , 0603
C4	GRM21BR60J475KE01L	Murata <sup>(1)</sup>	4.7 $\mu\text{F}$ 6.3V, 0805
C5, C6	GRM188R71E104KA01D	Murata <sup>(1)</sup>	0.1 $\mu\text{F}$ 25V, 0603
C7, C12, JP3			NP
C9	GRM1885C1H1R5CZ01	Murata <sup>(1)</sup>	1.5pF, 100V, $\pm 0.25\text{pF}$ , 0603
C10, C11	GRM1885C1H100JA01D	Murata <sup>(1)</sup>	10pF 50V, 0603
J2			NP, SMA, Edge Conn.
J3	571-41031480		AMPMODU Breakaway Headers 40 P(6pos) R/A HEADER GOLD
JP1, JP2	CRCW04020000Z	Vishay <sup>(2)</sup>	0 $\Omega$ , 0402
L2	LQG18HN39NJ00	Murata <sup>(1)</sup>	39nH, $\pm 5\%$ , 0603
L3	LQG18HN33NJ00	Murata <sup>(1)</sup>	33nH, $\pm 5\%$ , 0603
R3	CRCW0402100KFKEA		100k $\Omega$ , 0402
R4			NP
Y1	ABLS-13.52313MHz-10J4Y	Abracon <sup>(3)</sup>	13.52313MHz, HC49/US
Y2	DSX321GK-13.52313MHz	KDS <sup>(4)</sup>	NP, (13.52313MHz, $-40^{\circ}\text{C}$ to $+105^{\circ}\text{C}$ ), DSX321GK
U1	<b>MICRF220AYQS</b>	<b>Micrel, Inc.<sup>(5)</sup></b>	<b>300MHz to 450MHz, 3.3V ASK/OOK Receiver with RSSI and Squelch</b>

**Notes:**

1. Murata: [www.murata.com](http://www.murata.com).
2. Vishay: [www.vishay.com](http://www.vishay.com).
3. Abracon: [www.abracon.com](http://www.abracon.com).
4. KDS: [www.kds.info/index\\_en.htm](http://www.kds.info/index_en.htm).
5. Micrel, Inc.: [www.micrel.com](http://www.micrel.com).



**MICRF220 Evaluation Board (315MHz) Bill of Materials**

Item	Part Number	Manufacturer	Description
C3	GRM1885C1H1R5CZ01	Murata <sup>(1)</sup>	1.5pF 100V, ±0.25pF, 0603
C4	GRM21BR60J475KE01L	Murata <sup>(1)</sup>	4.7µF 6.3V, 0805
C5, C6	GRM188R71E104KA01D	Murata <sup>(1)</sup>	0.1µF 25V, 0603
C7, C12, JP3			NP
C9	GRM1885C1H1R2CZ01	Murata <sup>(1)</sup>	1.2pF, 100V, ±0.25pF, 0603
C10, C11	GRM1885C1H100JA01D	Murata <sup>(1)</sup>	10pF 50V, 0603
J2			NP, SMA, Edge Conn.
J3	571-41031480	Mouser <sup>(2)</sup>	AMPMODU Breakaway Headers 40 P(6pos) R/A HEADER GOLD
JP1, JP2	CRCW04020000Z	Vishay <sup>(3)</sup>	0Ω, 0402
L2, L3	LQG18HN68NJ00	Murata <sup>(1)</sup>	68nH, ±5%, 0603
R3	CRCW0402100KFKEA		100kΩ, 0402
R4			NP
Y1	ABLS-9.81713MHz-10J4Y	Abracon <sup>(4)</sup>	9.81713MHz, HC49/US
Y2	DSX321GK-9.81713MHz	KDS <sup>(5)</sup>	NP, (9.81713MHz, -40°C to +105°C), DSX321GK
<b>U1</b>	<b>MICRF220AYQS</b>	<b>Micrel, Inc.<sup>(6)</sup></b>	<b>300MHz to 450MHz, 3.3V ASK/OOK Receiver with RSSI and Squelch</b>

**Notes:**

1. Murata: [www.murata.com](http://www.murata.com).
2. Mouser: [www.mouser.com](http://www.mouser.com).
3. Vishay: [www.vishay.com](http://www.vishay.com).
4. Abracon: [www.abracon.com](http://www.abracon.com).
5. KDS: [www.kds.info/index\\_en.htm](http://www.kds.info/index_en.htm).
6. Micrel, Inc.: [www.micrel.com](http://www.micrel.com).

## Package Information

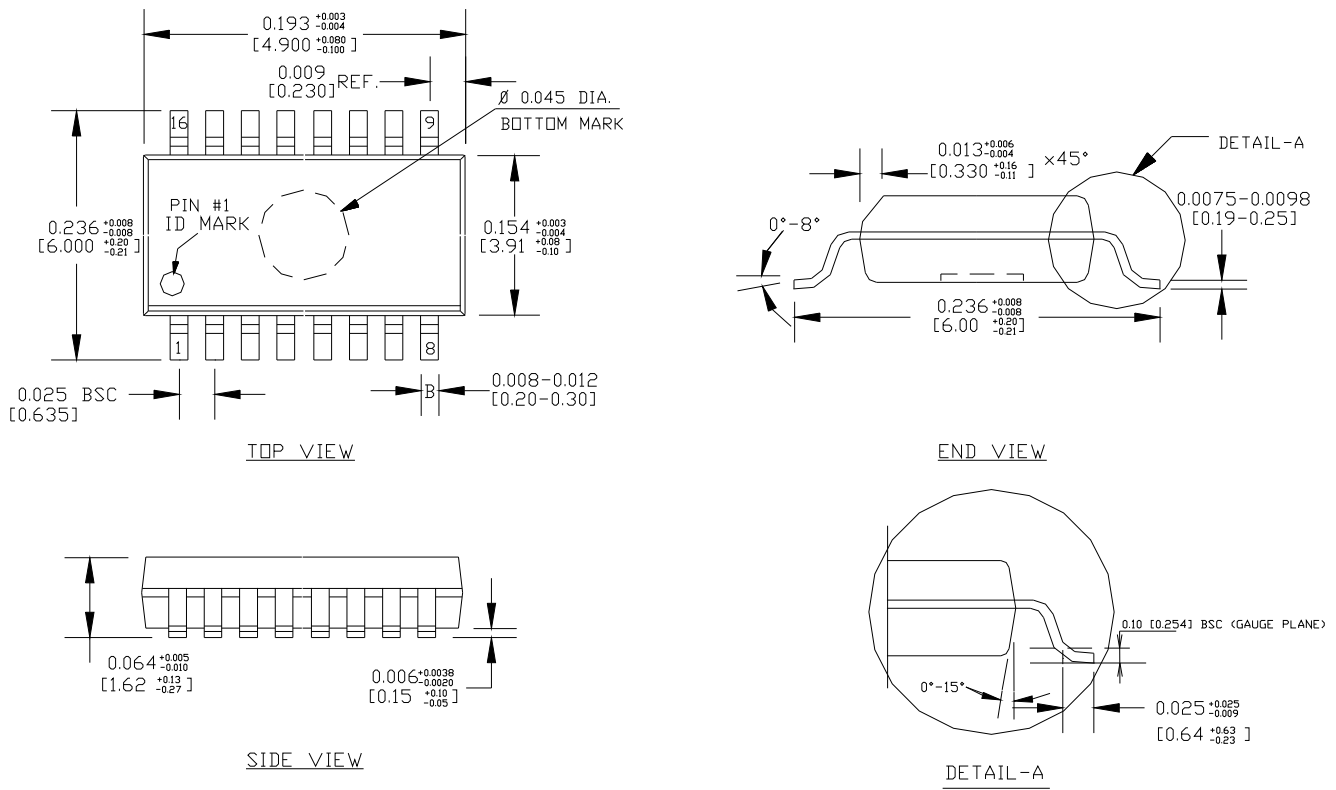

### NOTE:

1. ALL DIMENSIONS ARE IN INCHES [MM].
2. LEAD COPLANARITY SHOULD BE  $0.004''$  [0.10 mm] MAX.
3. MAX MISALIGNMENT BETWEEN TOP AND BOTTOM CENTER OF PACKAGE TO BE  $0.004''$  [0.10 mm].
4. THE LEAD WIDTH, B TO BE DETERMINED AT  $.0075$  [0.19 mm] FROM THE LEAD TIP.
5. BOTTOM MARK IS OPTIONAL, IT MAY NOT APPEAR ON THE ACTUAL UNITS.

### QSOP16 Package Type (AQS16)

MICREL, INC. 2180 FORTUNE DRIVE SAN JOSE, CA 95131 USA  
 TEL +1 (408) 944-0800 FAX +1 (408) 474-1000 WEB <http://www.micrel.com>

The information furnished by Micrel in this data sheet is believed to be accurate and reliable. However, no responsibility is assumed by Micrel for its use. Micrel reserves the right to change circuitry and specifications at any time without notification to the customer.

Micrel Products are not designed or authorized for use as components in life support appliances, devices or systems where malfunction of a product can reasonably be expected to result in personal injury. Life support devices or systems are devices or systems that (a) are intended for surgical implant into the body or (b) support or sustain life, and whose failure to perform can be reasonably expected to result in a significant injury to the user. A Purchaser's use or sale of Micrel Products for use in life support appliances, devices or systems is a Purchaser's own risk and Purchaser agrees to fully indemnify Micrel for any damages resulting from such use or sale.

© 2010 Micrel, Incorporated.