

## LOW DROPOUT VOLTAGE REGULATOR

### ■ GENERAL DESCRIPTION

The NJM2831 is a 100mA output low dropout voltage regulator with ON/OFF control.

Advanced Bipolar technology achieves low noise, high ripple rejection and low quiescent current.

2.0V to 15.5V output voltage range, 1 $\mu$ F small decoupling capacitor, built-in noise bypass capacitor make the NJM2831 suitable for various applications.

### ■ PACKAGE OUTLINE



NJM2831F

### ■ FEATURES

- Output voltage options available      2.1 ~ 15.5V (0.1V step)
- High Ripple Rejection                    75dB typ. (f=1kHz Vo=3V Version)
- Output Noise Voltage                    Vno=45 $\mu$ Vrms typ.
- Output capacitor with 1.0 $\mu$ F ceramic capacitor (Vo $\geq$ 5.1V)
- Output Current                            Io(max.)=100mA
- High Precision Output                    Vo $\pm$ 1.0%
- Low Dropout Voltage                    0.10V typ. (Io=60mA)
- ON/OFF Control                            (Active High)
- Internal Short Circuit Current Limit
- Internal Thermal Overload Protection
- Bipolar Technology
- Package Outline                            SOT-23-5

### ■ PIN CONFIGURATION

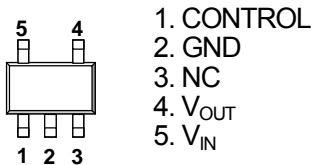

NJM2831

### ■ EQUIVALENT CIRCUIT

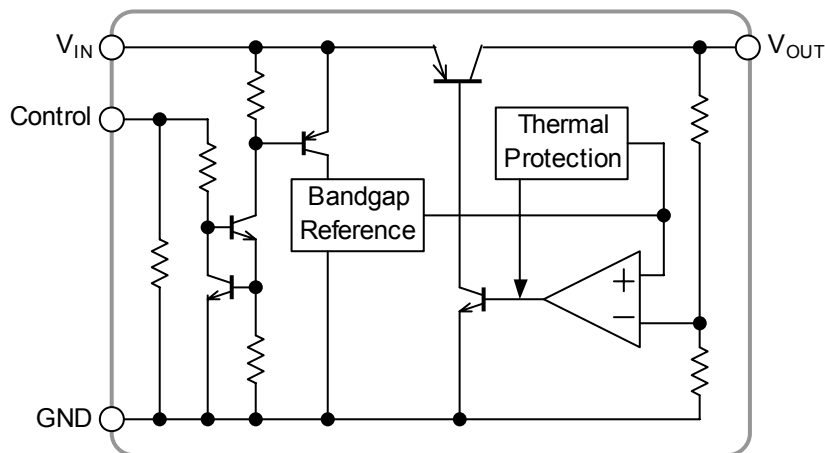

# NJM2831

www.DataSheet4U.com

## ■ OUTPUT VOLTAGE

Device Name	V <sub>OUT</sub>	Device Name	V <sub>OUT</sub>	Device Name	V <sub>OUT</sub>	Device Name	V <sub>OUT</sub>
NJM2831F21	2.1V	NJM2831F06	6.0V	NJM2831F92	9.2V	NJM2831F13	13.0V
NJM2831F03	3.0V	NJM2831F64	6.4V	NJM2831F10	10.0V	NJM2831F135	13.5V
NJM2831F33	3.3V	NJM2831F08	8.0V	NJM2831F116	11.6V	NJM2831F15	15.0V
NJM2831F05	5.0V	NJM2831F85	8.5V	NJM2831F12	12.0V	NJM2831F155	15.5V
NJM2831F53	5.3V	NJM2831F09	9.0V	NJM2831F125	12.5V		

Output voltage options available : 2.1 ~ 15.5V (0.1V step)

## ■ ABSOLUTE MAXIMUM RATINGS (Ta=25°C)

PARAMETER	SYMBOL	RATINGS	UNIT
Input Voltage	V <sub>IN</sub>	+20	V
Control Voltage	V <sub>CONT</sub>	+20(*1)	V
Power Dissipation	P <sub>D</sub>	SOT-23-5 500(*2) 250(*3)	MW
Operating Temperature	Topr	-40~+85	°C
Storage Temperature	Tstg	-40~+150	°C

(\*1): When input voltage is less than +20V, the absolute maximum control voltage is equal to the input voltage.

(\*2): Mounted on glass epoxy board based on EIA/JEDEC. (114.3x76.2x1.6mm: 2Layers)

(\*3): Device itself.

## ■ ELECTRICAL CHARACTERISTICS

(V<sub>IN</sub>=Vo+1V, C<sub>IN</sub>=0.1μF, Co=1.0μF (2.8V<Vo≤5V:Co=2.2μF, Vo≤2.8V: Co=4.7μF), Ta=25°C)

PARAMETER	SYMBOL	TEST CONDITION	MIN.	TYP.	MAX.	UNIT	
Output Voltage	Vo	Io=30mA	-1.0%	-	+1.0%	V	
Quiescent Current	I <sub>Q</sub>	Io=0mA, expect I <sub>cont</sub>	Vo≤5V Version	-	120	180	μA
			5V<Vo≤10V Version	-	135	195	μA
			10V<Vo≤15V Version	-	150	210	μA
Quiescent Current at Control OFF	I <sub>Q(OFF)</sub>	V <sub>CONT</sub> =0V	-	-	100	nA	
Output Current	Io	Vo=0.3V	100	130	-	mA	
Line Regulation	ΔVo/ΔV <sub>IN</sub>	V <sub>IN</sub> =Vo+1V ~ Vo+6V (Vo≤12V Version) V <sub>IN</sub> =Vo+1V ~ 18V (Vo>12V Version), Io=30mA	-	-	0.10	%/V	
Load Regulation	ΔVo/ΔIo	Io=0 ~ 60mA	-	-	0.03	%/mA	
Dropout Voltage	ΔV <sub>I-O</sub>	Io=60mA	-	0.10	0.18	V	
Ripple Rejection	RR	e <sub>in</sub> =200mVrms, f=1kHz, Io=10mA, Vo=3V Version	-	75	-	dB	
Average Temperature Coefficient of Output Voltage	ΔVo/ΔTa	Ta=0 ~ 85°C, Io=10mA	-	± 50	-	ppm/ °C	
Output Noise Voltage	V <sub>NO</sub>	f=10Hz ~ 80kHz, Io=10mA Vo=3V Version	-	45	-	μVrms	
Control Current	I <sub>cont</sub>	V <sub>CONT</sub> =1.6V	-	3	12	μA	
Control Voltage for ON-state	V <sub>CONT(ON)</sub>		1.6	-	-	V	
Control Voltage for OFF-state	V <sub>CONT(OFF)</sub>		-	-	0.6	V	
Input Voltage	V <sub>IN</sub>		-	-	18	V	

(\*4): The above specification is a common specification for all output voltages.

Therefore, it may be different from the individual specification for a specific output voltage.

## ■ TEST CIRCUIT

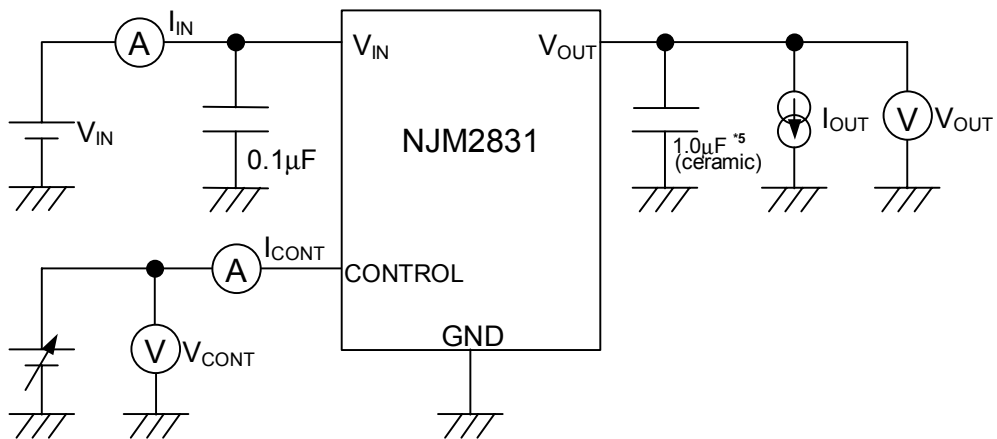

\*5 2.8V <  $V_O$  ≤ 5V version:  $C_o$  = 2.2 μF (ceramic)  
 $V_O$  ≤ 2.8V version:  $C_o$  = 4.7 μF (ceramic)

## ■ TYPICAL APPLICATIONS

① In the case where ON/OFF Control is not required:

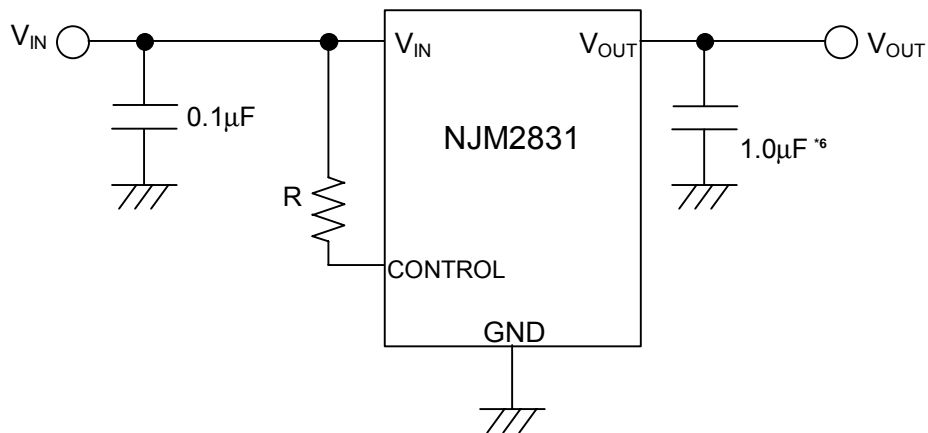

\*6 2.8V <  $V_O$  ≤ 5V version:  $C_o$  = 2.2 μF  
 $V_O$  ≤ 2.8V version:  $C_o$  = 4.7 μF

Connect control terminal to  $V_{IN}$  terminal

# NJM2831

www.DataSheet4U.com

② In use of ON/OFF CONTROL:

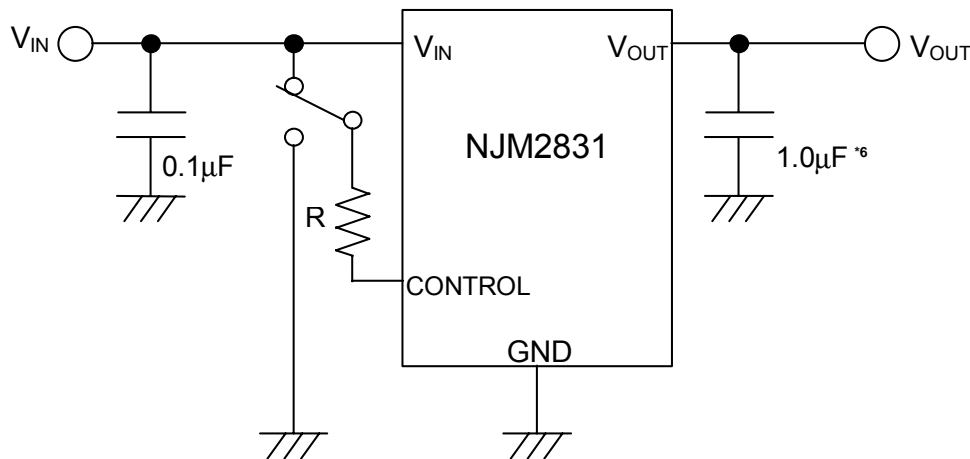

\*6 2.8V <  $V_O$  ≤ 5V version:  $C_O = 2.2\mu\text{F}$   
 $V_O \leq 2.8\text{V}$  version:  $C_O = 4.7\mu\text{F}$

State of control terminal:

- "H" → output is enabled.
- "L" or "open" → output is disabled.

\*In the case of using a resistance "R" between  $V_{IN}$  and control.

The current flow into the control terminal while the IC is ON state ( $I_{CONT}$ ) can be reduced when a pull up resistance "R" is inserted between  $V_{IN}$  and the control terminal.

The minimum control voltage for ON state ( $V_{CONT(ON)}$ ) is increased due to the voltage drop caused by  $I_{CONT}$  and the resistance "R". The  $I_{CONT}$  is temperature dependence as shown in the "Control Current vs. Temperature" characteristics. Therefore, the resistance "R" should be carefully selected to ensure the control voltage exceeds the  $V_{CONT(ON)}$  over the required temperature range.

\*Input Capacitance  $C_{IN}$

Input capacitance  $C_{IN}$  is required to prevent oscillation and reduce power supply ripple for applications with high power supply impedance or a long power supply line.

Use the  $C_{IN}$  value of  $0.1\mu\text{F}$  greater to avoid the problem.

$C_{IN}$  should connect between GND and  $V_{IN}$  as short as possible.

\*Output Capacitance  $C_O$

Output capacitor ( $C_O$ ) is required for a phase compensation of the internal error amplifier. The capacitance and the equivalent series resistance (ESR) influences stability of the regulator.

This product is designed to work with a low ESR capacitor for the  $C_O$ ; however, use of recommended capacitance or greater value is essential for stable operation.

Use of a smaller  $C_O$  may cause excess output noise or oscillation of the regulator due to lack of the phase compensation.

Therefore, use  $C_O$  with the recommended capacitance or greater value and connect between  $V_O$  terminal and GND terminal with minimal wiring. The recommended capacitance depends on the output voltage. Low voltage regulator requires greater value of the  $C_O$ . Thus, check the recommended capacitance for each output voltage.

Use of a greater  $C_O$  reduces output noise and ripple output, and also improves transient response of the output voltage against rapid load change.

## POWER DISSIPATION vs. AMBIENT TEMPERATURE

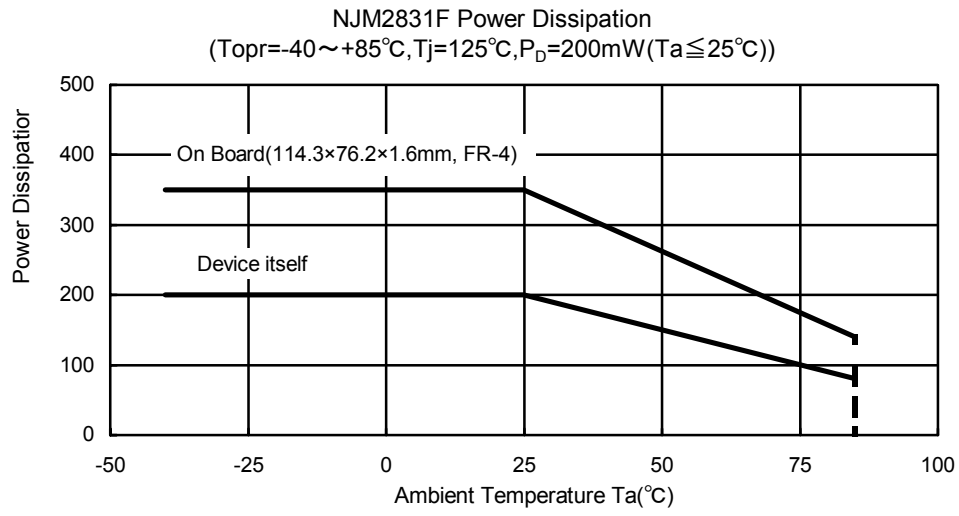

# NJM2831

www.DataSheet4U.com

## TYPICAL CHARACTERISTICS

### DC CHARACTERISTICS (3V Version)

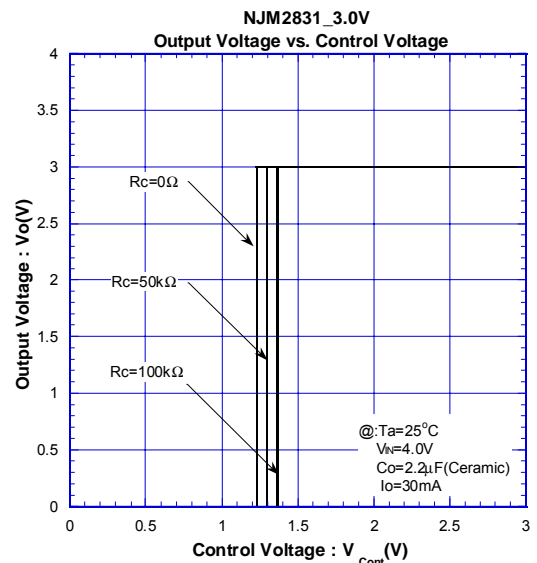
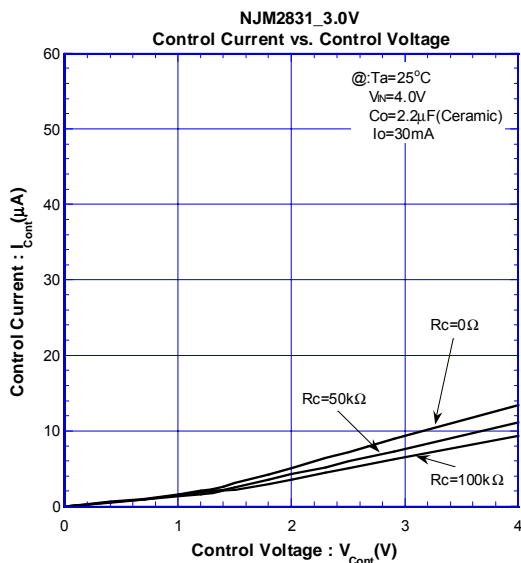
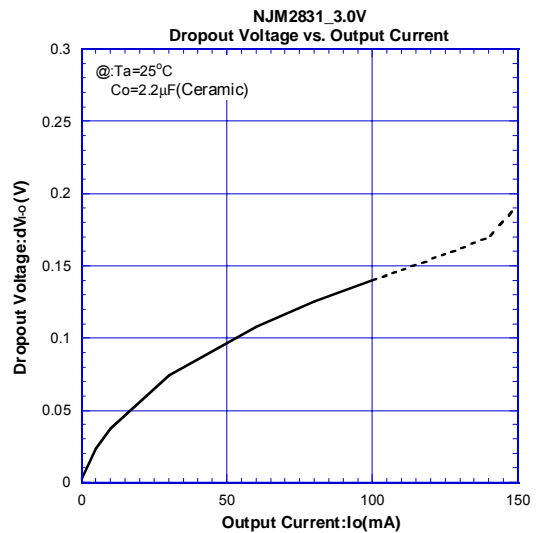
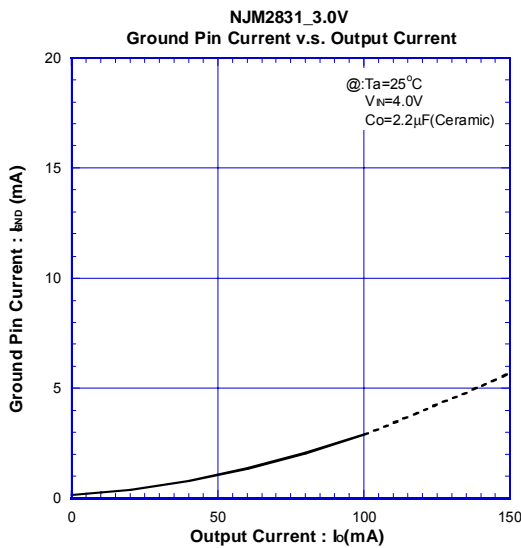
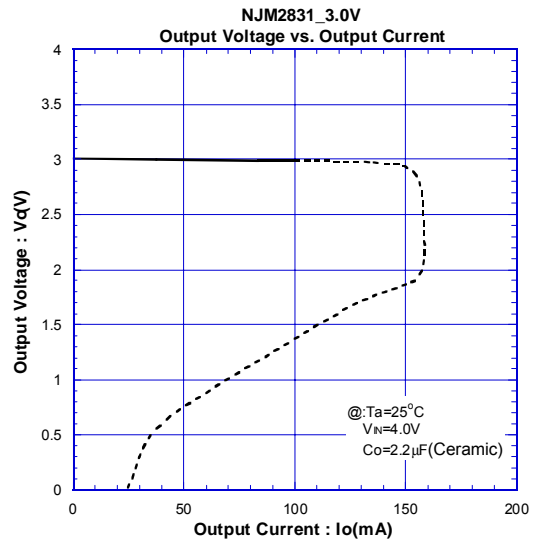
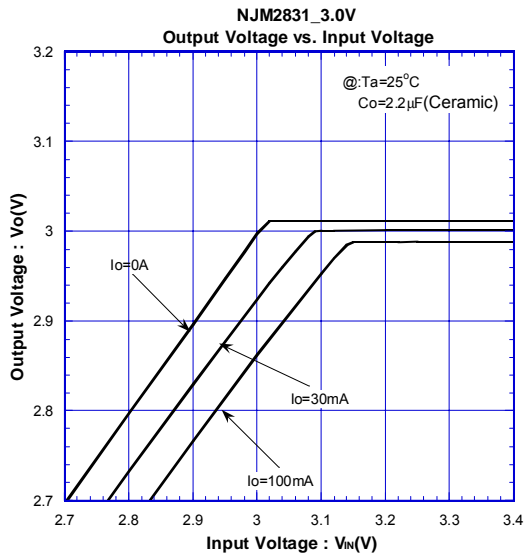

## ■ TYPICAL CHARACTERISTICS

### ● DC CHARACTERISTICS (3V Version)

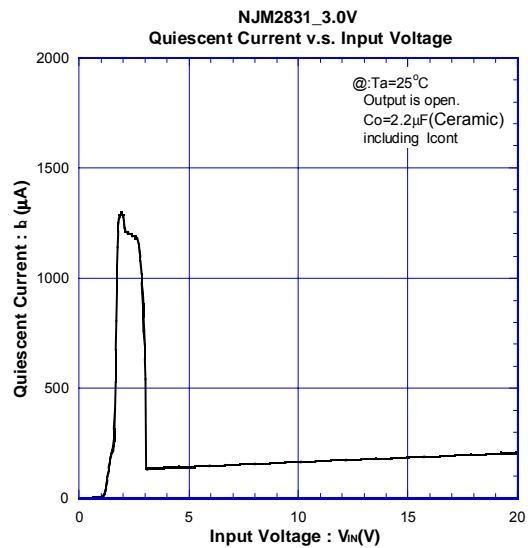
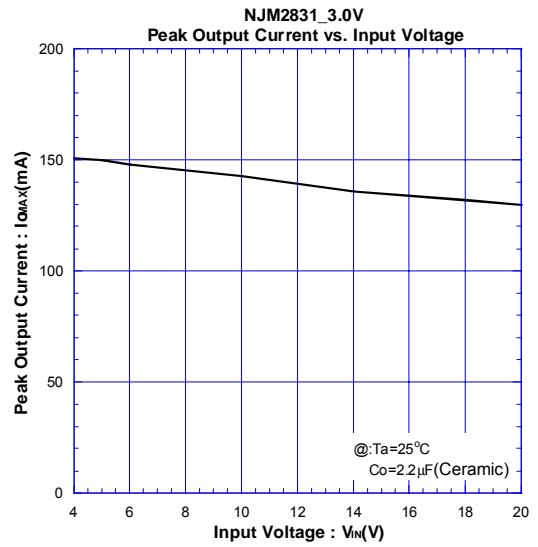
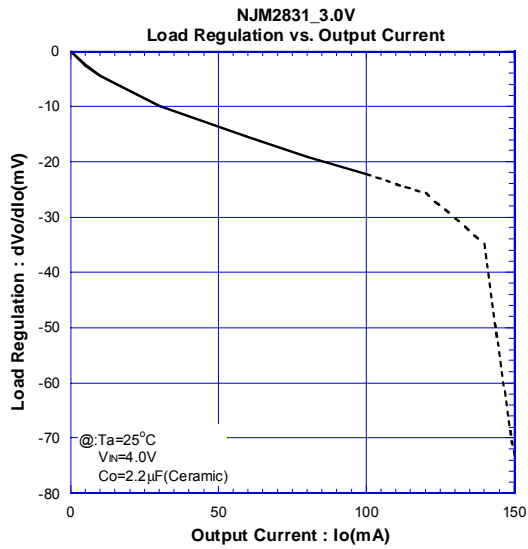

# NJM2831

W W W

## TYPICAL CHARACTERISTICS

### AC CHARACTERISTICS (3V Version)

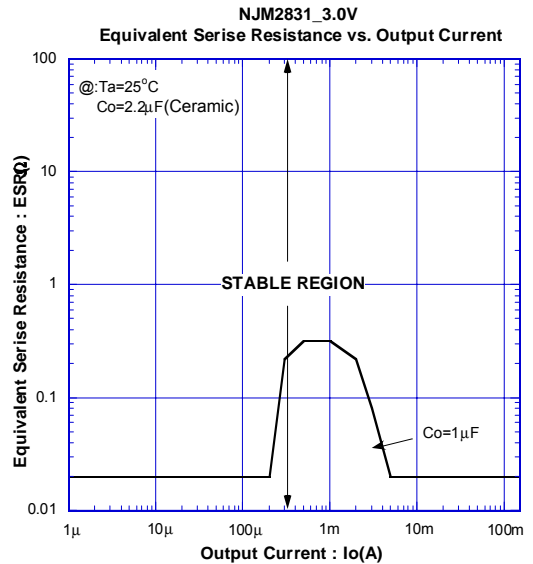
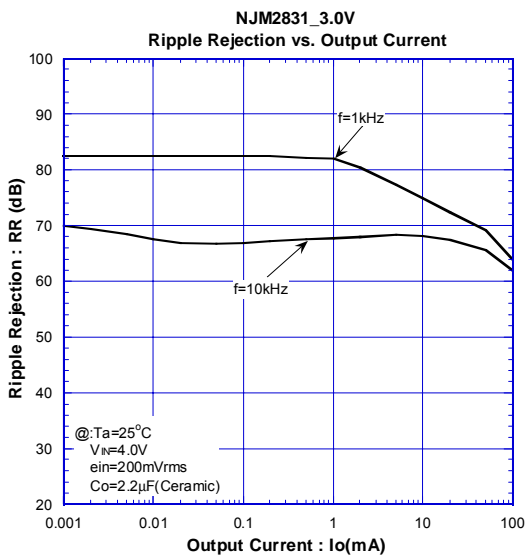
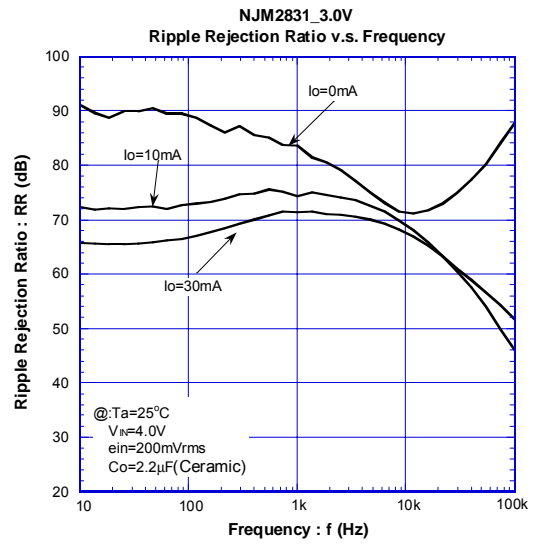
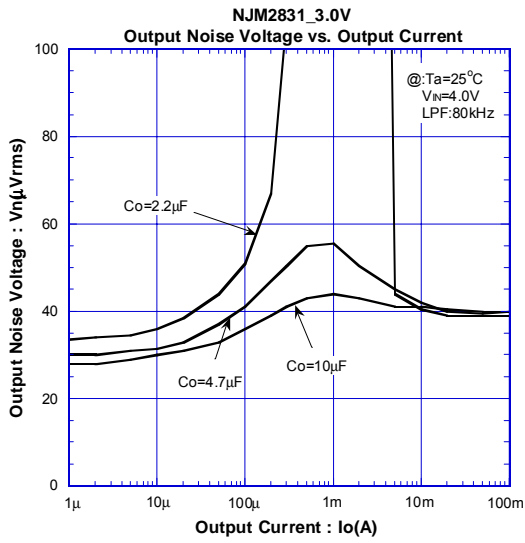



## ■ TYPICAL CHARACTERISTICS

### ● TEMPERATURE CHARACTERISTICS (3V Version)

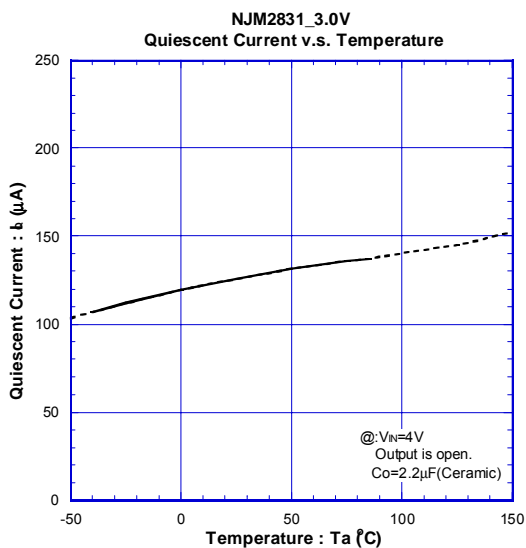
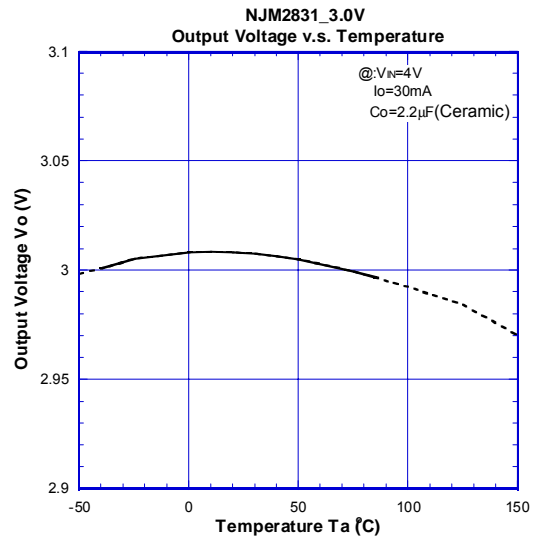
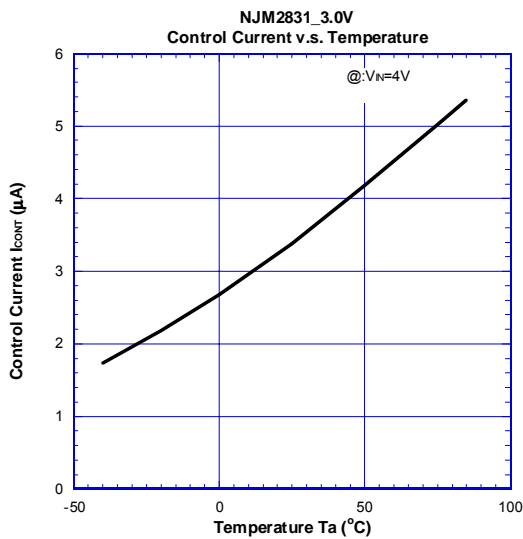
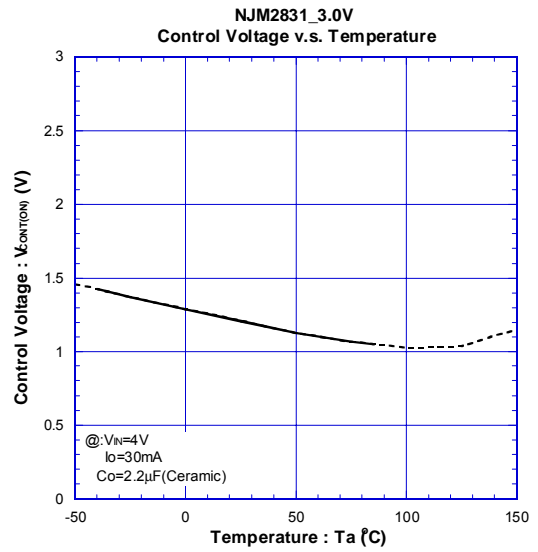
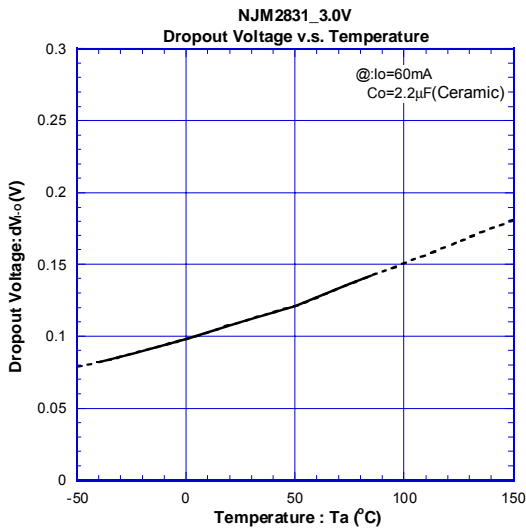

# NJM2831

www.DataSheet4U.com

## TYPICAL CHARACTERISTICS

### TEMPERATURE CHARACTERISTICS (3V Version)

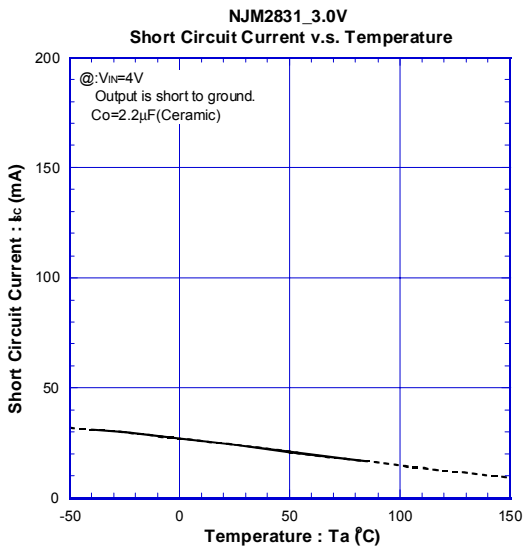
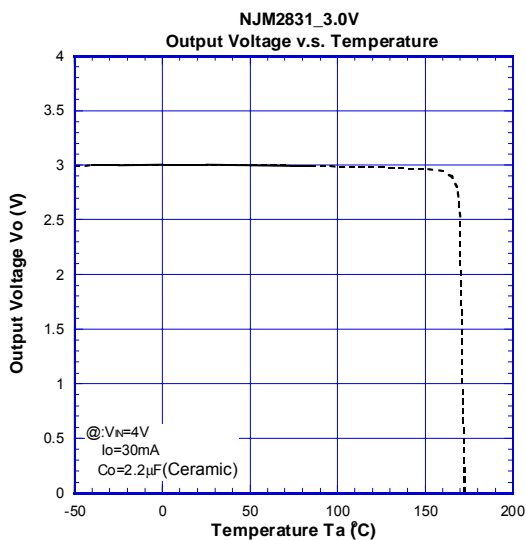
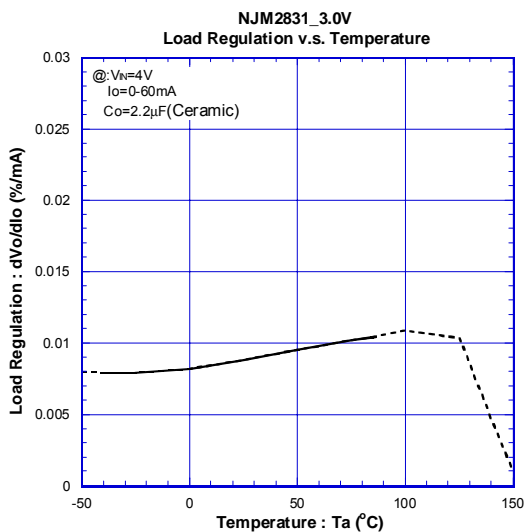
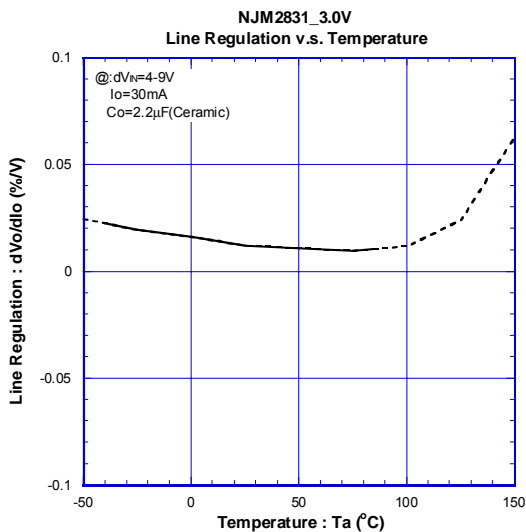

## ●TRANSIENT RESPONSE (3V Version)

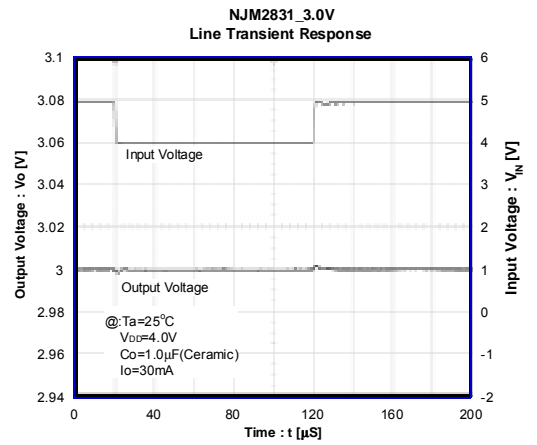
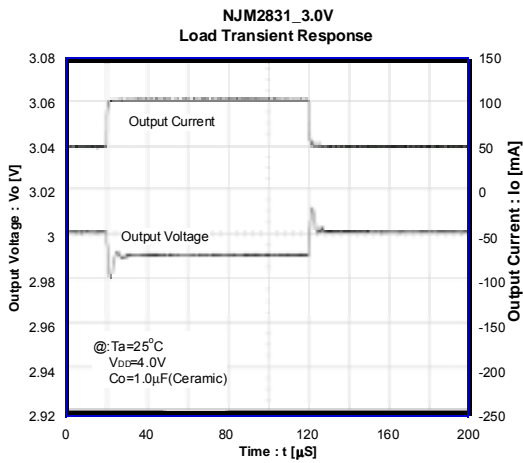
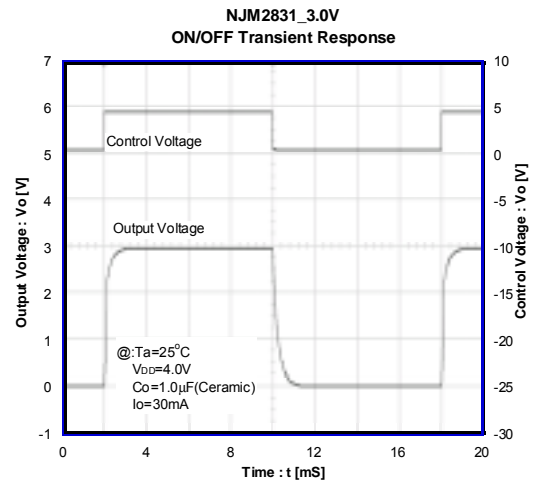
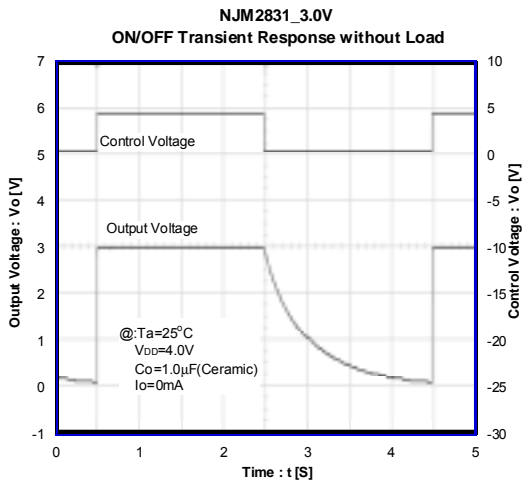

# NJM2831

www.DataSheet4U.com

## TYPICAL CHARACTERISTICS

### DC CHARACTERISTICS (8.5V Version)

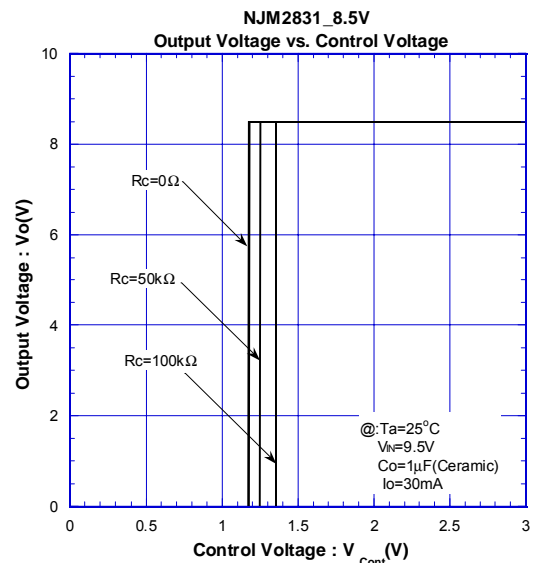
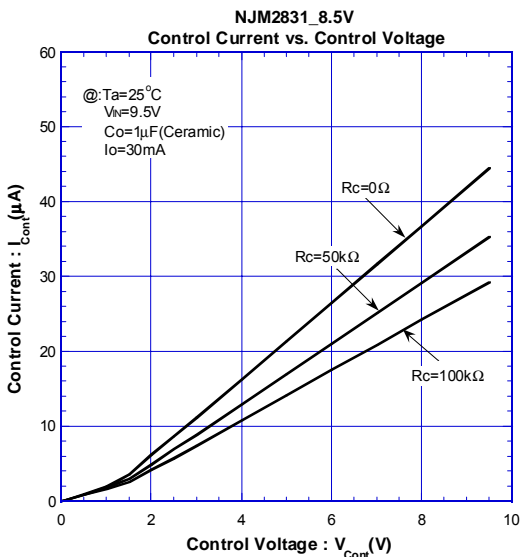
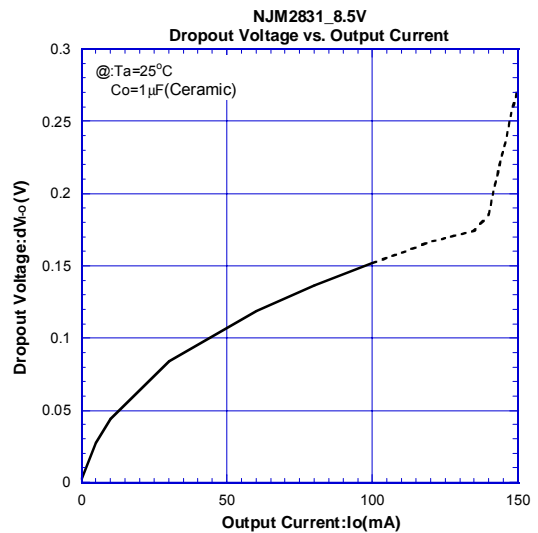
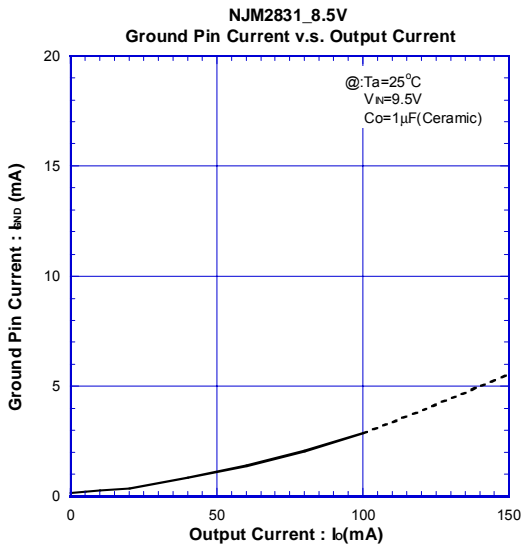
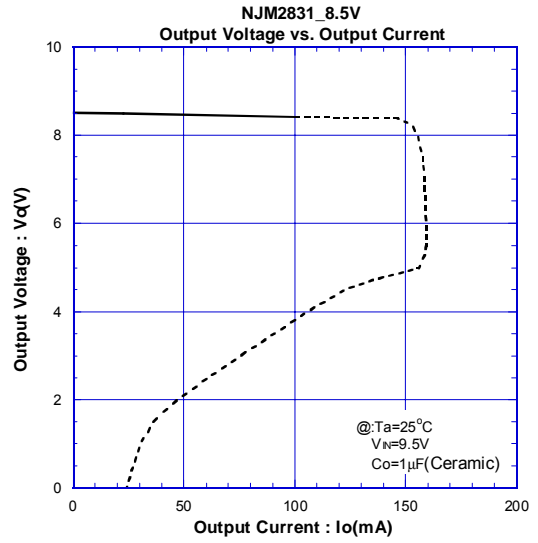
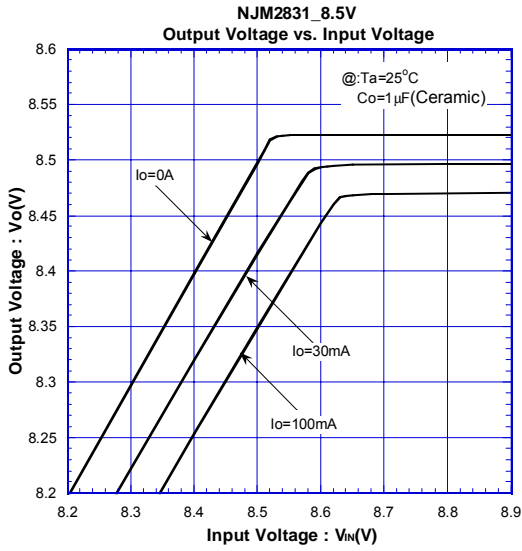

## ■ TYPICAL CHARACTERISTICS

### ● DC CHARACTERISTICS (8.5V Version)

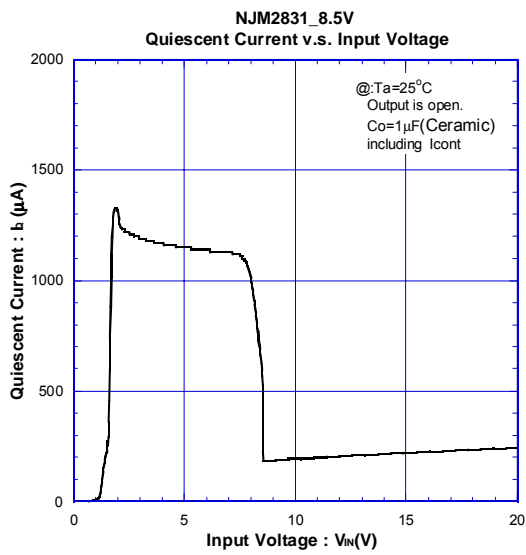
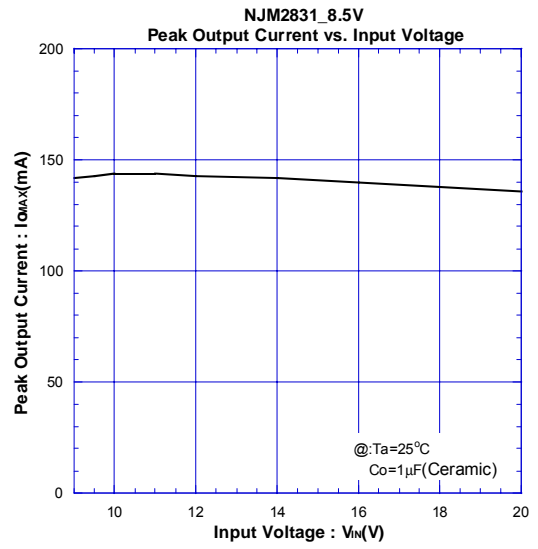
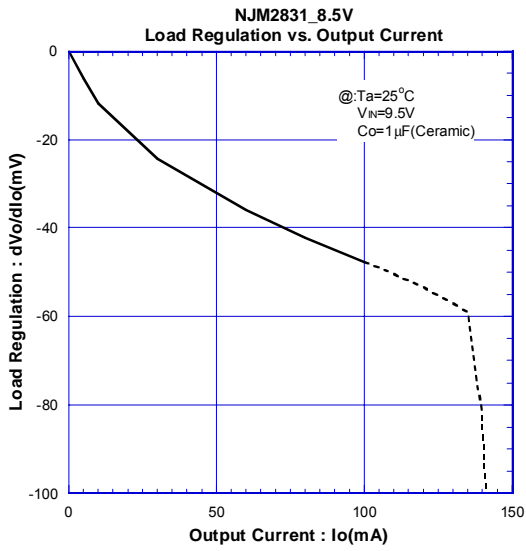

## TYPICAL CHARACTERISTICS

### AC CHARACTERISTICS (8.5V Version)

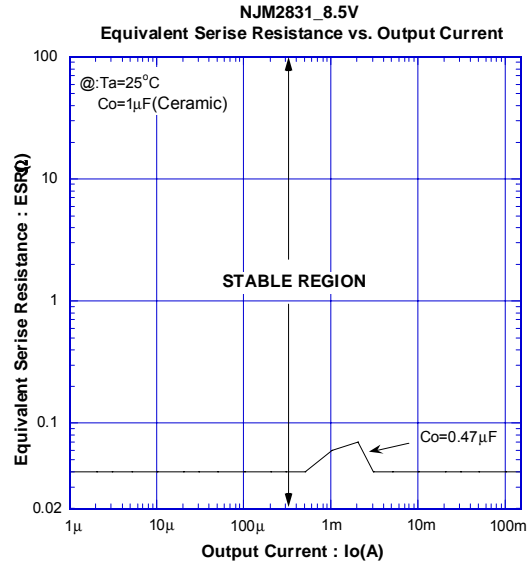
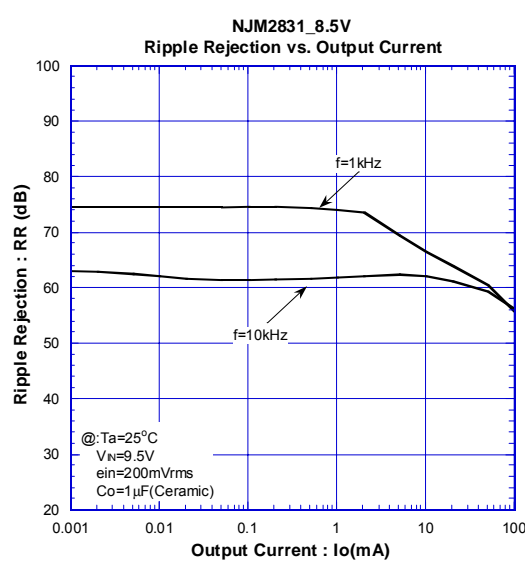
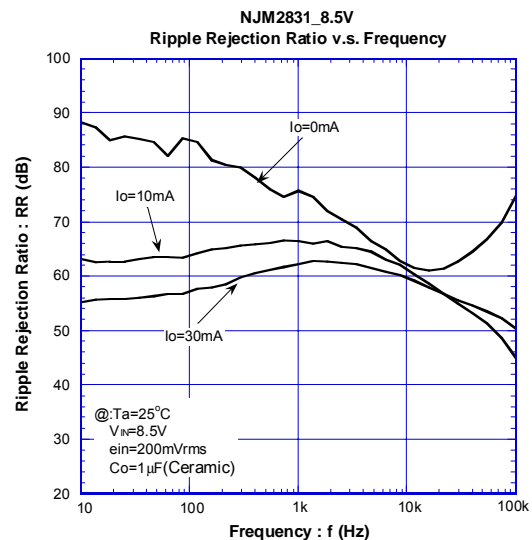
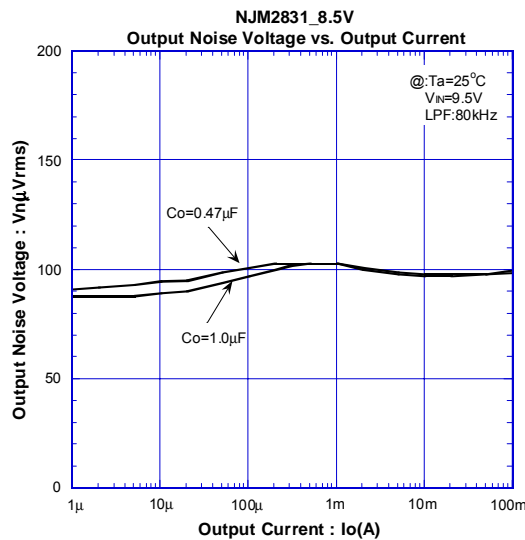

## ■ TYPICAL CHARACTERISTICS

### ● TEMPERATURE CHARACTERISTICS (8.5V Version)

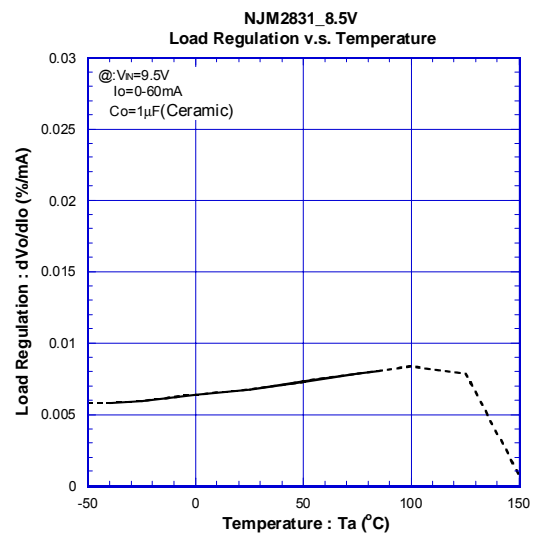
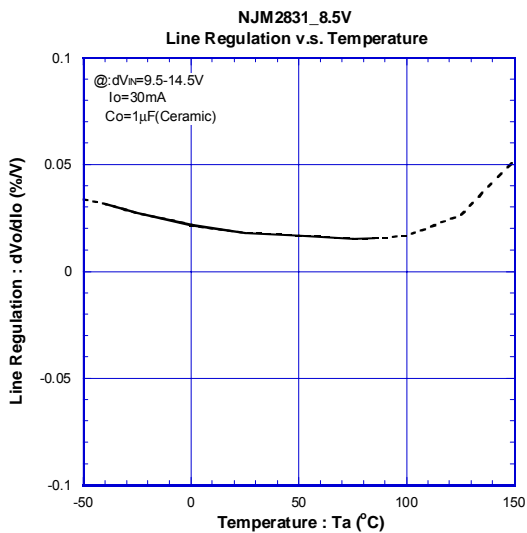
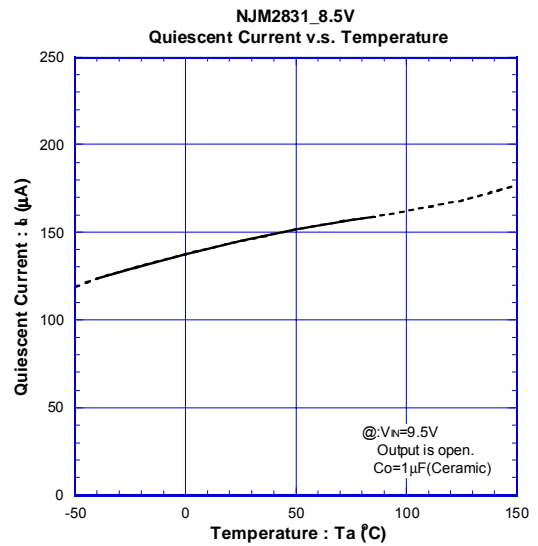
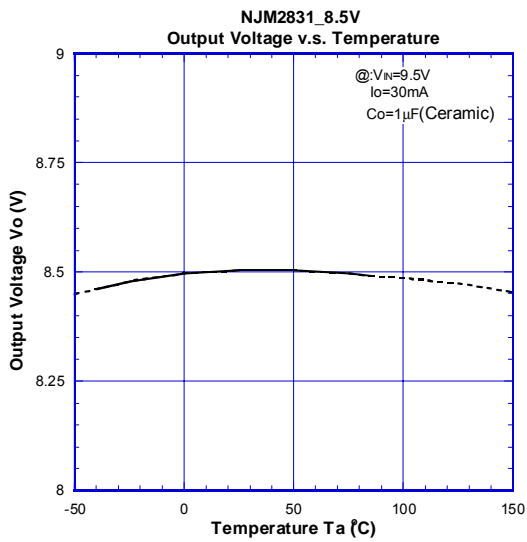
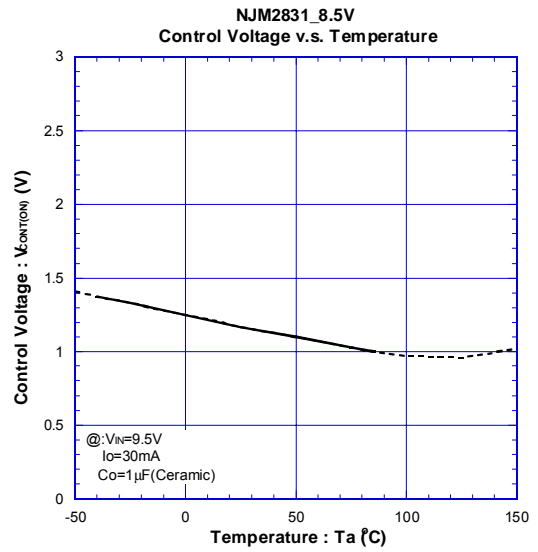
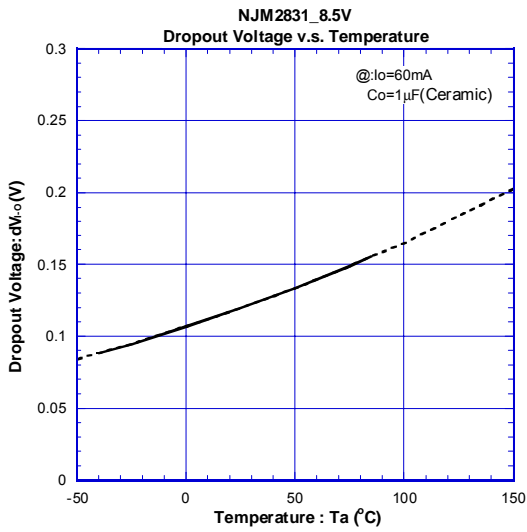

# NJM2831

www.DataSheet4U.com

## TYPICAL CHARACTERISTICS

### TEMPERATURE CHARACTERISTICS (8.5V Version)

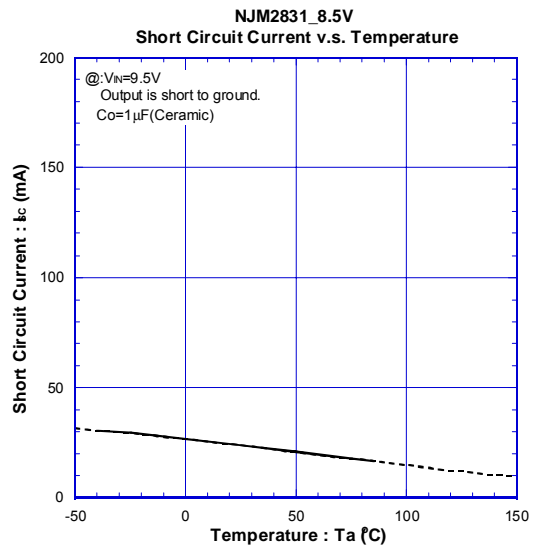
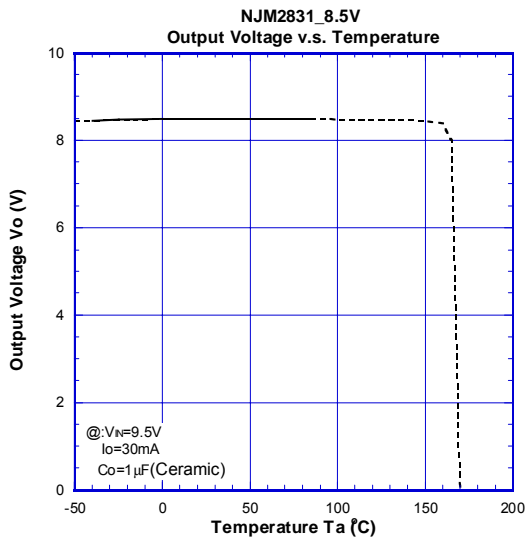

### TRANSIENT RESPONSE (8.5V Version)

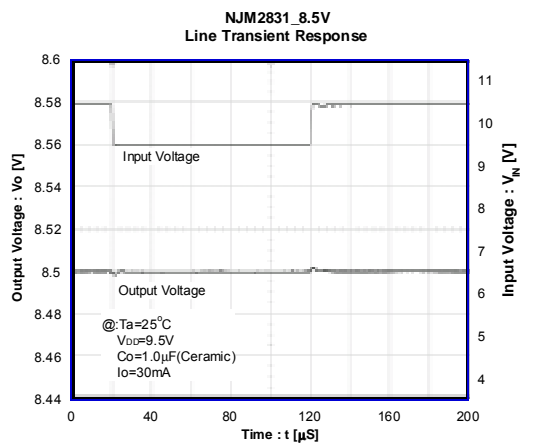
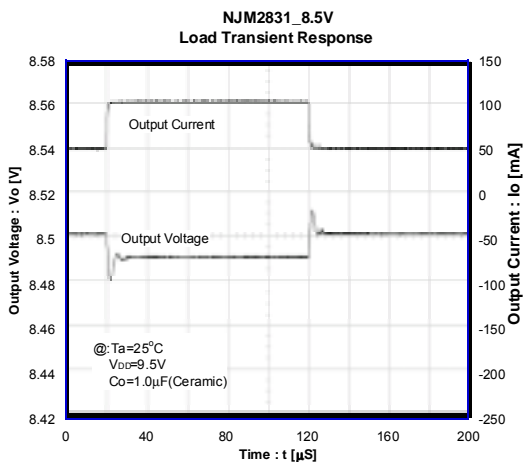
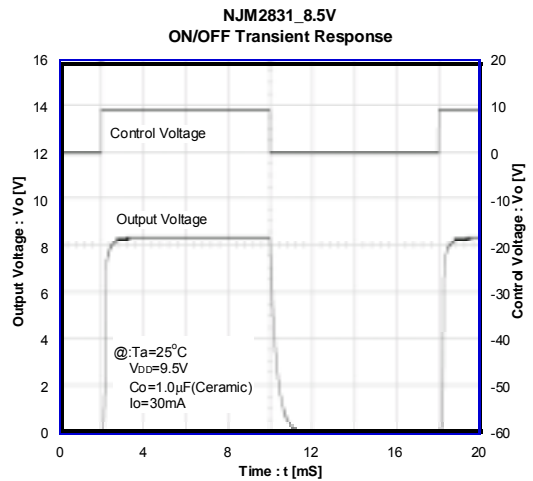
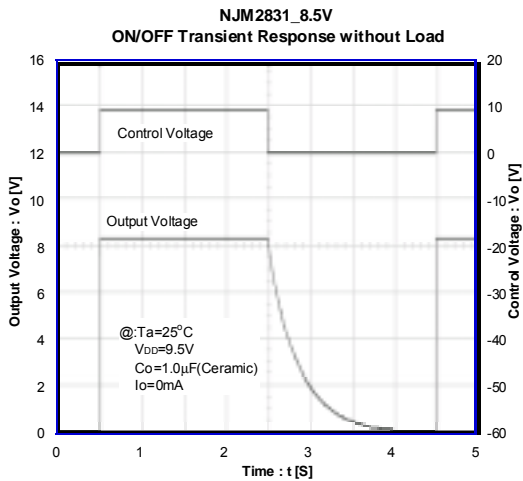



## ■ TYPICAL CHARACTERISTICS

### ● DC CHARACTERISTICS (15V Version)

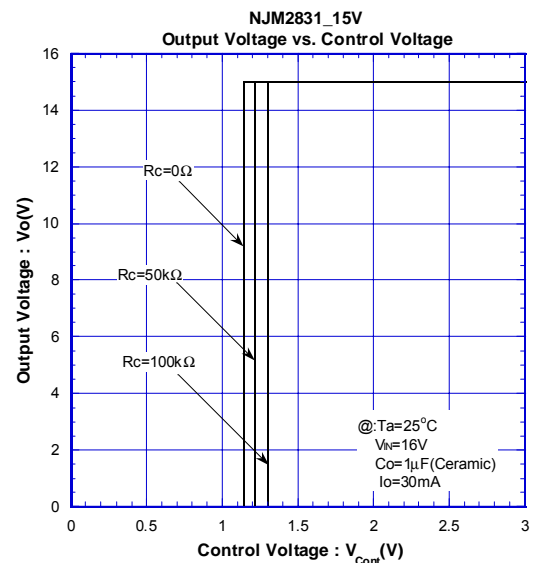
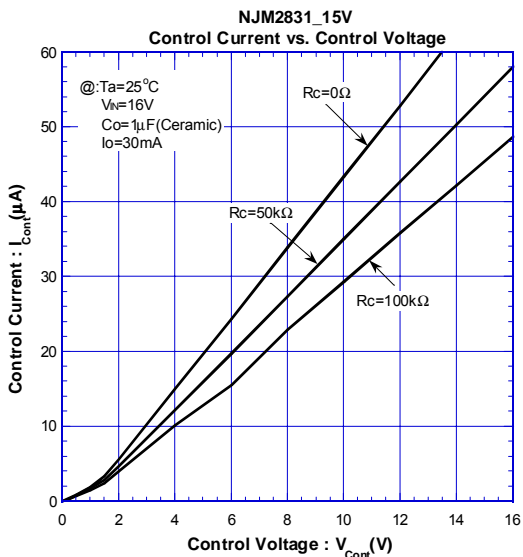
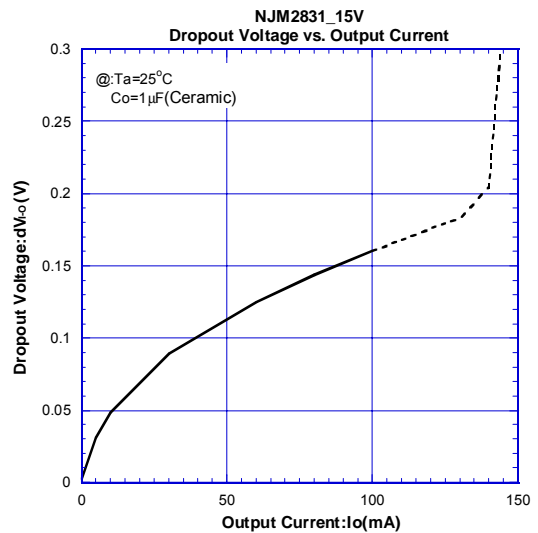
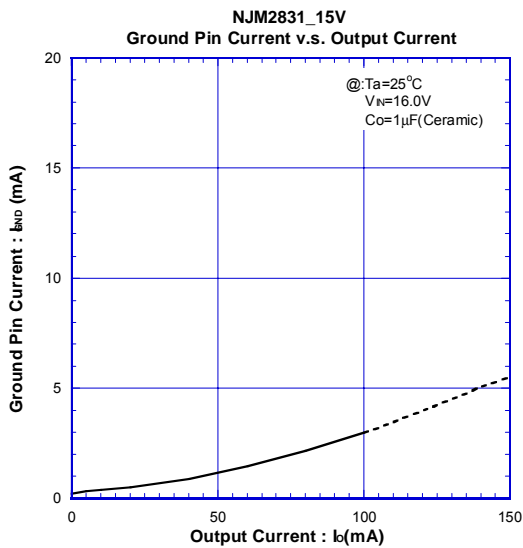
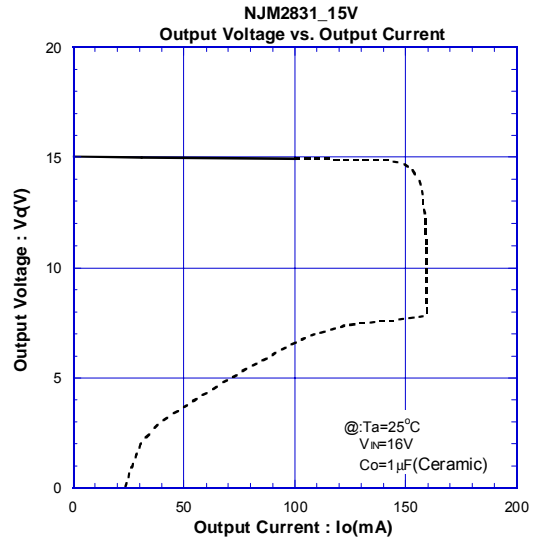
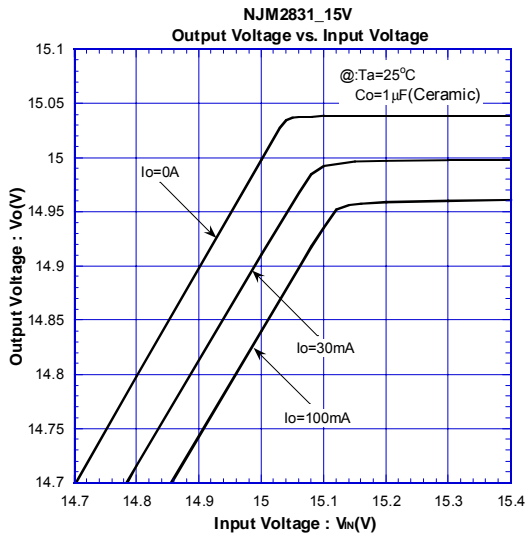

# NJM2831

www.DataSheet4U.com

## TYPICAL CHARACTERISTICS

### DC CHARACTERISTICS (15V Version)

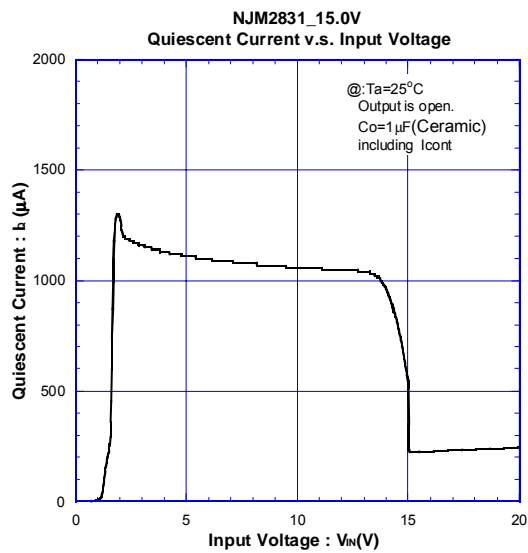
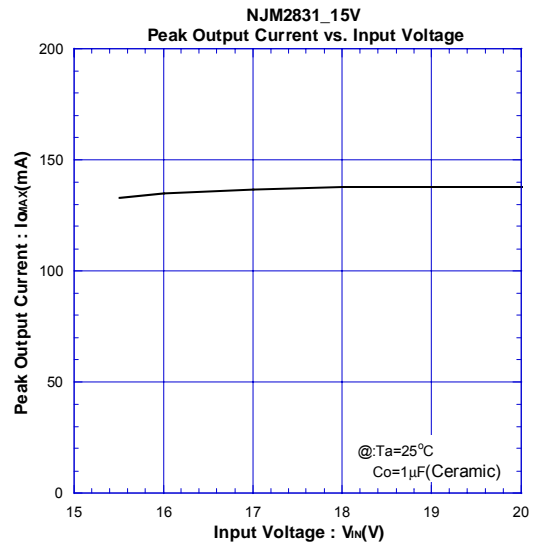
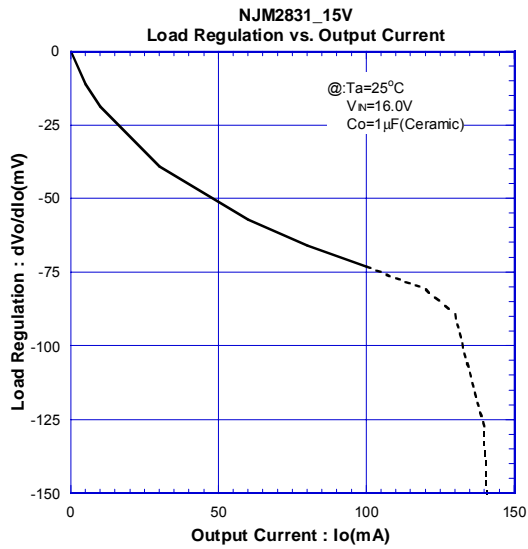

## TYPICAL CHARACTERISTICS

### ●AC CHARACTERISTICS (15V Version)

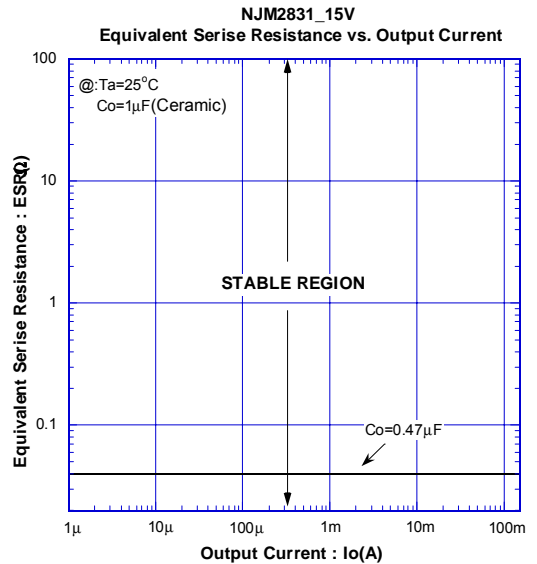
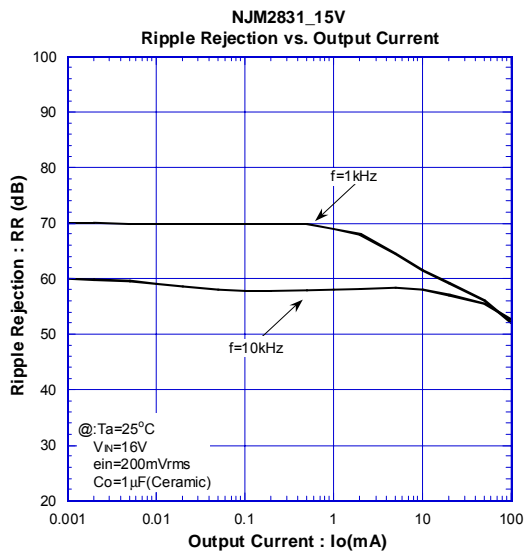
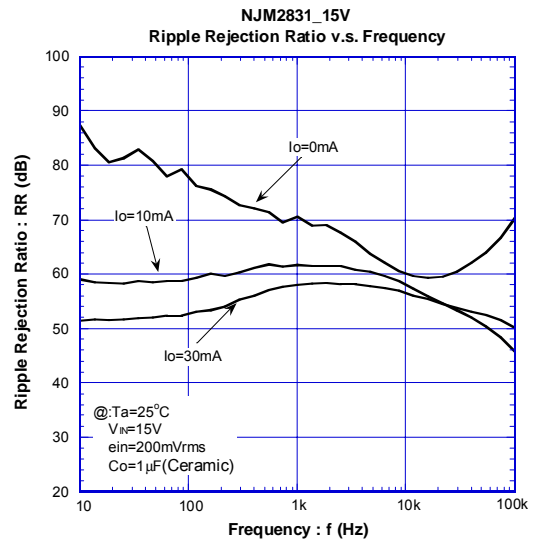
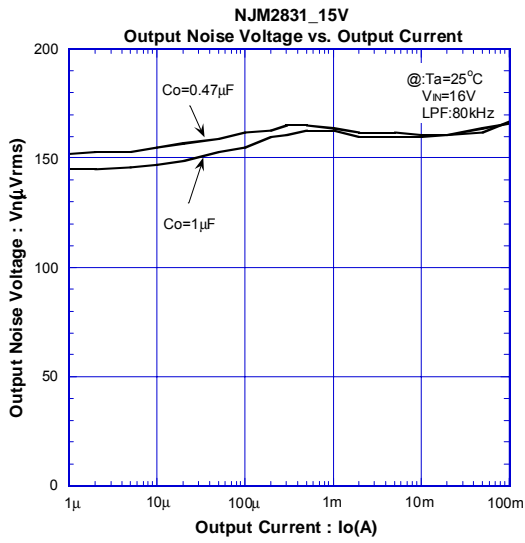

# NJM2831

www.DataSheet4U.com

## ■ TYPICAL CHARACTERISTICS

### ● TEMPERATURE CHARACTERISTICS (15V Version)

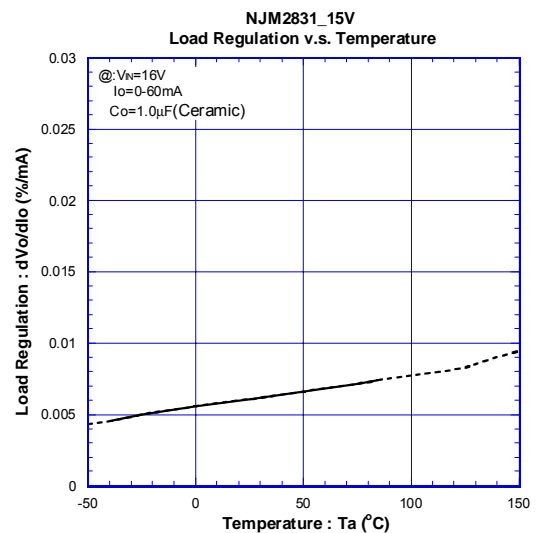
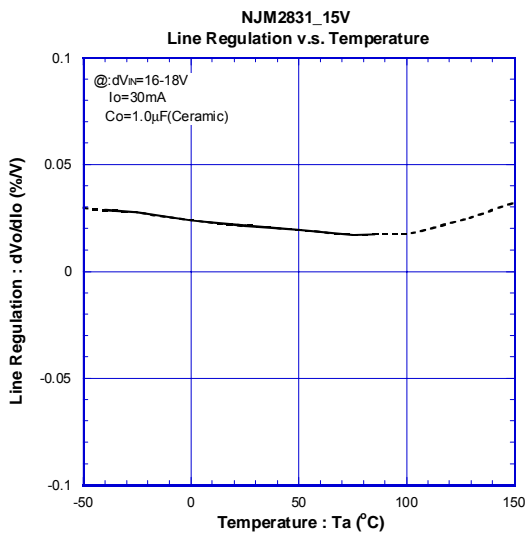
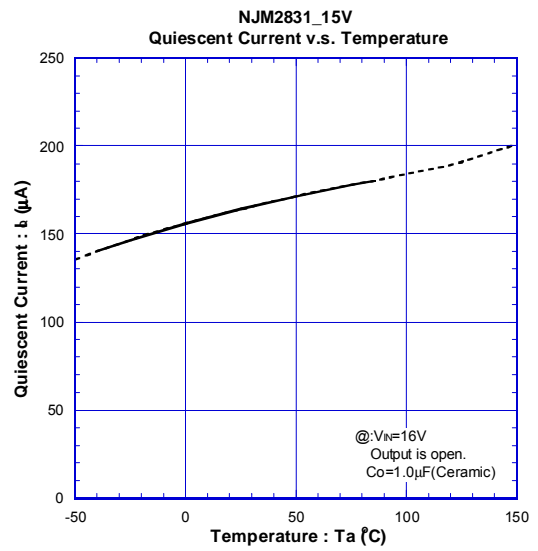
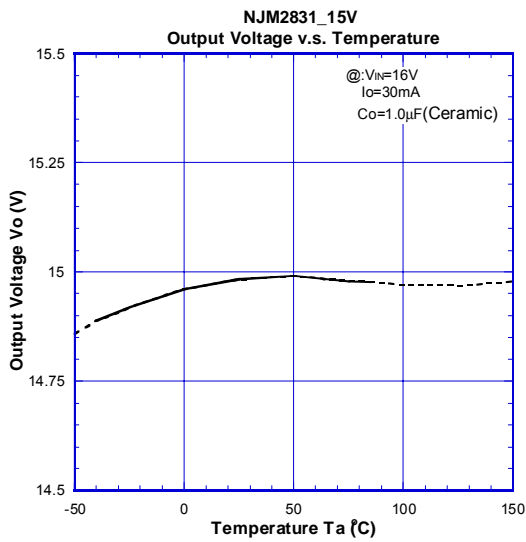
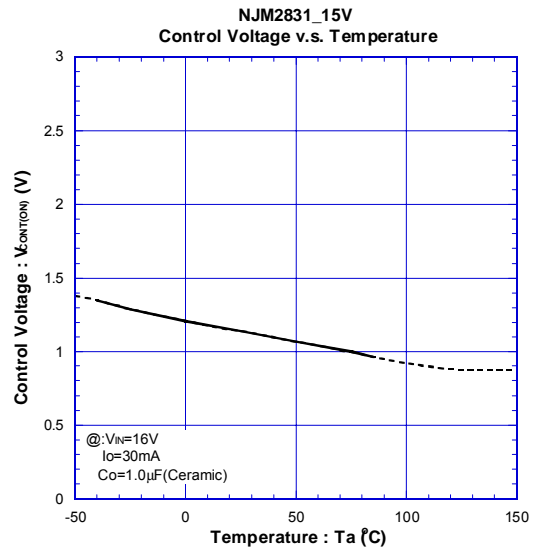
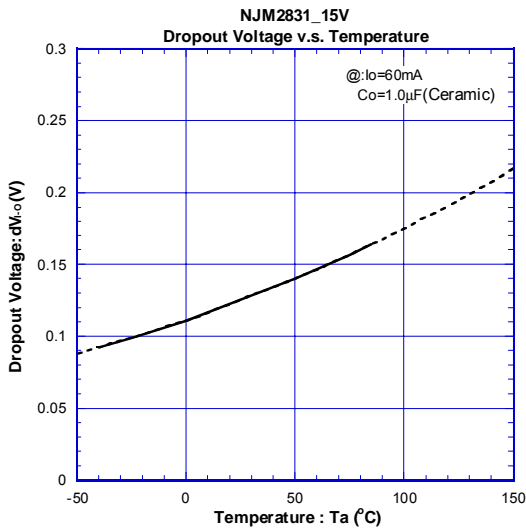

## ■ TYPICAL CHARACTERISTICS

### ● TEMPERATURE CHARACTERISTICS (15V Version)

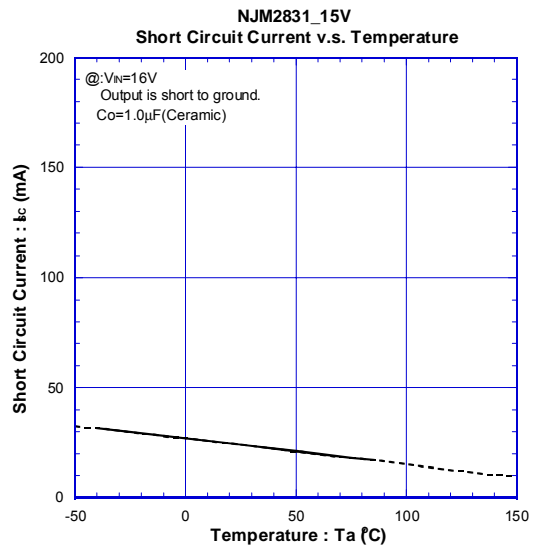
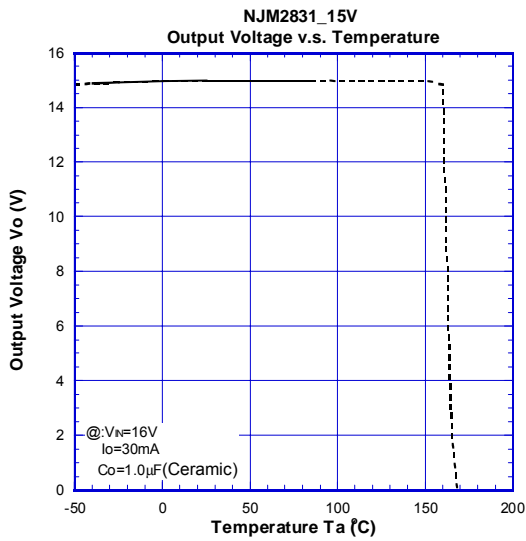

### ● TRANSIENT RESPONSE (15V Version)

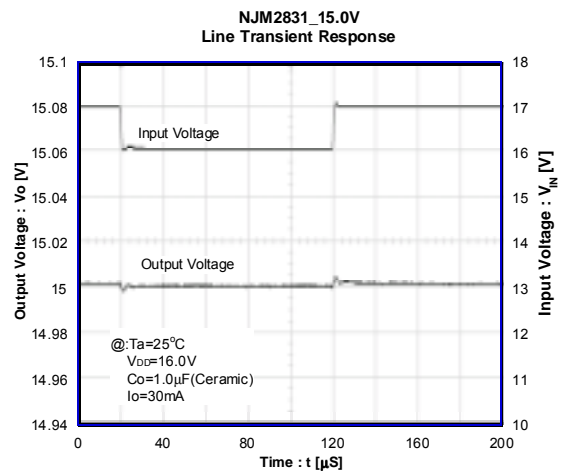
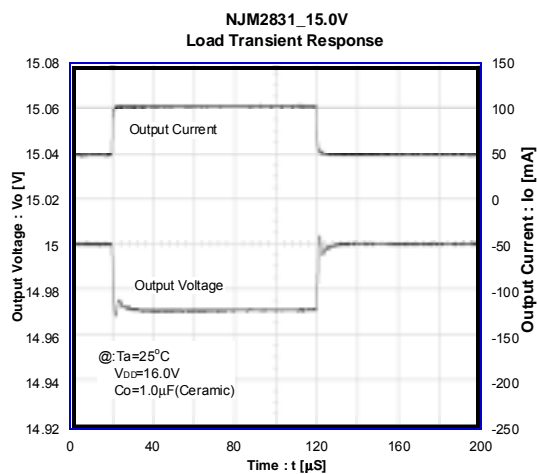
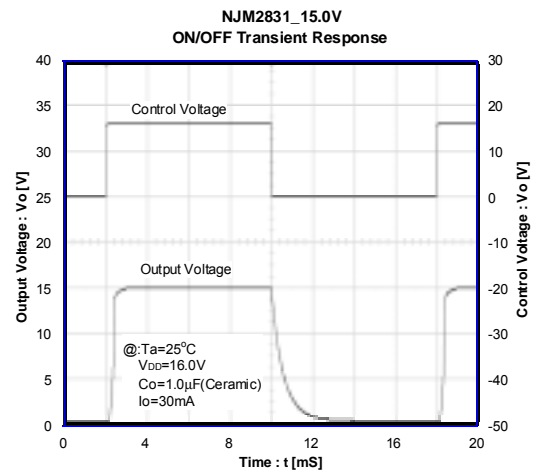
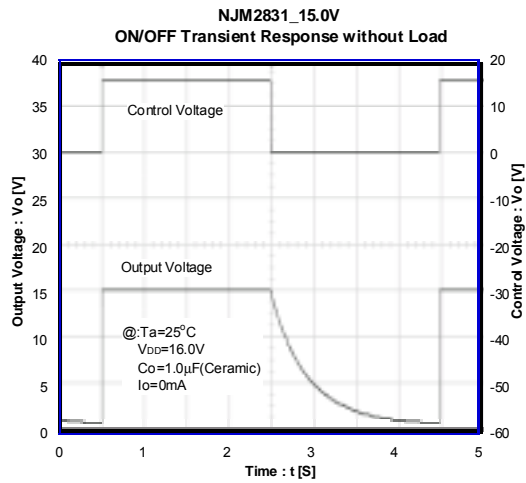

# NJM2831

www.DataSheet4U.com

---

**[CAUTION]**

The specifications on this databook are only given for information, without any guarantee as regards either mistakes or omissions. The application circuits in this databook are described only to show representative usages of the product and not intended for the guarantee or permission of any right including the industrial rights.